

ANSI/ISA-S5.2-1976 (R1992)

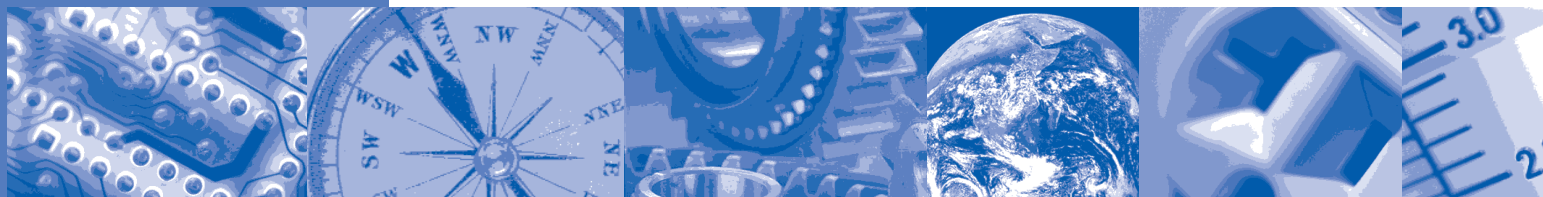

Binary Logic Diagrams for Process Operations



Reaffirmed 13 July 1992

ISA-S5.2 — Binary Logic Diagrams for Process Operations

ISBN 0-87664-331-4

Copyright © 1992 by the Instrument Society of America. All rights reserved. Printed in the United States of America. No part of this publication may be reproduced, stored in a retrieval system, or transmitted in any form or by any means (electronic, mechanical, photocopying, recording, or otherwise), without the prior written permission of the publisher.

ISA
67 Alexander Drive
P.O. Box 12277
Research Triangle Park, North Carolina 27709

Preface

This preface is included for informational purposes and is not part of Standard ISA-S5.2.

This Standard has been prepared as a part of the service of ISA toward a goal of uniformity in the field of instrumentation. To be of real value, this document should not be static, but should be subject to periodic review. Toward this end, the Society welcomes all comments and criticisms, and asks that they be addressed to the Secretary, Standards and Practices Board, ISA, 67 Alexander Drive, P.O. Box 12277, Research Triangle Park, NC 27709, Telephone (919) 549-8411, e-mail: standards@isa.org.

The ISA Standards and Practices Department is aware of the growing need for attention to the metric system of units in general, and the International System of Units (SI) in particular, in the preparation of instrumentation standards. The Department is further aware of the benefits to USA users of ISA Standards of incorporating suitable references to the SI (and the metric system) in their business and professional dealings with other countries. Toward this end this Department will endeavor to introduce SI-acceptable metric units in all new and revised standards to the greatest extent possible. *The Metric Practice Guide*, which has been published by the American Society for Testing and Materials as ANSI designation Z210.1 (ASTM E380-76, IEEE Std. 286-1975), and further revisions, will be the reference guide for definitions, symbols, abbreviation, and conversion factors.

It is the Policy of ISA to encourage and welcome the participation of all concerned individuals and interests in the development of ISA Standards. Participation in the ISA Standards making process by an individual in no way constitutes endorsement by the employer of that individual of ISA or any of the Standards which ISA develops.

The system described in this Standard is intended to meet the needs of people who are concerned with the operation of process systems. The guide for the Standard was American National Standards Institute (ANSI) Standard Y32.14.1973, Graphic Symbols for Logic Diagrams, which the committee attempted to follow so far as practical for the intended users of the ISA Standard.

The Committee also referred to National Electric Manufacturers Association Standards ICS 1-102, Graphic Symbols for Logic Diagrams, whose symbols bear resemblance to those of the ANSI Standard, and ICS 1-103, Static Switching Control Devices, which may eventually be supplanted by ICS 1-102. Reference was also made to National Fluid Power Association Recommended Standard T.3.7.68.2, Graphic Symbols for Fluidic Devices and Circuits. In addition, numerous other industrial standards were reviewed.

The following people served on the 1976 SP5.2 Committee:

NAME	COMPANY
George Platt, Chairman	Bechtel Power Company
Edward J. Blahut	Procon Incorporated, Pacific Operations
Sanford Chalfin	Fluor Corporation
Louis Costea	Hunt-Wesson Foods, Incorporated
Russell C. Greer	Bailey Meter Company
Roy Lazar	Carnation Company

Frank Mehle (deceased)
Gary L. Pierce
Chuck Simms
John Vance
Robert Woo

Procon Incorporated, Pacific Operation
Shell Oil Company
Fisher Controls Company
United Process Control Systems
Los Angeles Department of Water & Power

The following people served on the 1981 (reaffirmation) SP5.2 Committee:

NAME

COMPANY

Russell C. Greer, Chairman
Edward J. Blahut
Sanford Chalfin
Louis Costea
Roy Lazar
Gary L. Pierce
George Platt
Charles Simms
John Vance
Robert Woo

Bailey Controls Company
Blahut Engineering, Inc.
Fluor Corporation (retired)
Hunt-Wesson Foods, Inc.
Carnation Company
Shell Oil Company
Bechtel Power Corporation
Fisher Controls Company
Comsysco
Los Angeles Department of Water & Power

The 1976 edition of this Standard was approved by the ISA Standards and Practices Board in November, 1975.

NAME

COMPANY

W. B. Miller, Chairman
P. Bliss
E. J. Byrne
W. Calder
B. A. Christensen
L. N. Combs
R. L. Galley
R. G. Hand, Secretary
T. J. Harrison
T. S. Imsland
P. S. Lederer
O. P. Lovett, Jr.
E. C. Magison
R. L. Martin
A. P. McCauley
T. A. Murphy
R. L. Nickens
G. Platt
A. T. Upfold
K. A. Whitman

Moore Products Company
Pratt & Whitney Aircraft Company
Brown & Root, Inc.
The Foxboro Company
Continental Oil Company
E. I. du Pont de Nemours & Company (retired)
Bechtel Power Corporation
ISA
IBM Corporation
Fisher Controls Company
National Bureau of Standards
E. I. du Pont de Nemours & Company
Honeywell, Inc.
Tex-A-Mation Engineering Inc.
Glidden-Durkee Div. SCM Corporation
The Fluor Corporation, Ltd.
Reynolds Metals Company
Bechtel Power Corporation
Polysar Ltd.
Allied Chemical Corporation

This standard was reaffirmed by the ISA Standards and Practices Board in March, 1981.

NAME

COMPANY

T. J. Harrison, Chairman	IBM Corporation
P. Bliss	Consultant
W. Calder	The Foxboro Company
B. A. Christensen	Continental Oil Company
M. R. Gorden-Clark	Scott Paper Company
R. T. Jones	Philadelphia Electric Company
R. Keller	Boeing Company
O. P. Lovett, Jr.	Jorden Valve
E. C. Magison	Honeywell, Inc.
A. P. McCauley	Diamond Shamrock Corporation
E. M. Nesvig	ERDCO Engineering Corporation
R. L. Nickens	Reynolds Metals Company
G. Platt	Bechtel Power Corporation
R. Prescott	Moore Products Company
R. W. Signor	General Electric Company
W. C. Weidman	Gilbert Associates, Inc.
K. A. Whitman	Allied Chemical Corporation
L. N. Combs*	
R. L. Galley*	
R. G. Marvin*	
W. B. Miller*	Moore Products Company
J. R. Williams*	Stearns-Rogers, Inc.

*Director Emeritus

Contents

1 Purpose	9
2 Scope	9
3 Use of symbols	9
4 Symbols	11
5 Bibliography	18
Appendix A —General application example	19
Appendix B —Complex time-element example	26
Appendix C — Loss of power supply for memory	27

1 Purpose

1.1 The purpose of this Standard is to provide a method of logic diagramming of binary interlock and sequencing systems for the startup, operation, alarm, and shutdown of equipment and processes in the chemical, petroleum, power generation, air conditioning, metal refining, and numerous other industries.

1.2 The Standard is intended to facilitate the understanding of the operation of binary systems, and to improve communications among technical, management, design, operating, and maintenance personnel concerned with the systems.

2 Scope

2.1 The Standard provides symbols, both basic and non-basic, for binary operating functions. The use of symbols in typical systems is illustrated in appendices.

2.2 The Standard is intended to symbolize the binary operating functions of a system in a manner that can be applied to any class of hardware, whether it be electronic, electrical, fluidic, pneumatic, hydraulic, mechanical, manual, optical, or other.

3 Use of symbols

3.1 By using the symbols designated as "basic," logic systems may be described with the use of only the most fundamental logic building blocks. The remaining symbols, not basic, are more comprehensive and enable logic systems to be diagrammed more concisely. Use of the non-basic symbols is optional.

3.2 A logic diagram may be more or less detailed depending on its intended use. The amount of detail in a logic diagram depends on the degree of refinement of the logic and on whether auxiliary, essentially non-logic, information is included.

As an example of refinement of detail: A logic system may have two opposing inputs, e.g., a command to open and a command to close, which do not normally exist simultaneously; the logic diagram may or may not go so far as to specify the outcome if both the commands were to exist at the same time. In addition, explanatory notes may be added to the diagram to record the logic rationale.

Non-logic information may also be added, if desired, e.g., reference document identification, tag numbers, terminal markings, etc.

In these ways, the diagram may provide the level of detail appropriate, for example, for communication between a designer of pneumatic circuits and a designer of electric circuits, or may provide a broad-view system-description for a plant manager.

3.3 The existence of a logic signal may correspond physically to either the existence or the non-existence of an instrument signal, depending on the particular type of hardware system and the circuit design philosophy that are selected.* For example, a high-flow alarm may be chosen to be actuated by an electric switch whose contacts open on high flow; on the other hand, the high-flow alarm may be designed to be actuated by an electric switch whose contacts close on high flow. Thus, the high-flow condition may be represented physically by the absence of an electric signal or by the presence of the electric signal. The Standard does not attempt to relate the logic signal to an instrument signal of any specific kind.

3.4 A logic symbol that is shown in [Section 4](#) with three inputs — *A*, *B*, and *C* — is typical for the logic function having any number of two or more inputs.

3.5 The flow of intelligence is represented by lines that interconnect logic statements. The normal direction of flow is from left to right, or top to bottom. Arrowheads may be added to the flow lines wherever needed for clarity, and shall be added to lines whose flow is not in a normal direction.

3.6 A summary of the status of an operating system may be put in the diagram wherever it is deemed useful as a reference point or landmark in the sequence.

3.7 There may be misunderstanding of binary logic statements involving devices that are not recognizable as inherently having only two specific alternative states. For example, if it is stated that a valve is not closed, this could mean either (a) that the valve is open fully, or (b) that the valve is simply not closed, namely, that it may be in any position from almost closed to wide open. To aid accurate communication between writer and reader of the logic diagram, the diagram should be interpreted literally. Therefore, possibility (b) is the correct one.

If a valve is an open-close valve, then, to avoid misunderstanding, it is necessary to do one of the following:

- 1) Develop the logic diagram in such a way that it says exactly what is intended. If the valve is intended to be open, then it should be so stated and not be stated as being not closed.
- 2) Have a separate note specifying that the valve always assumes either the closed or the open position.

By contrast, a device such as a motor-driven pump is either operating or stopped, barring some special situations. To say that the pump is not operating usually clearly denotes that it has stopped.

The following definitions apply to devices that have open, closed, or intermediate positions. The positions stated are nominal to the extent that there are differential-gap and dead band in the instrument that senses the position of the device.

Open position: a position that is 100-percent open.

Not-open position: a position that is less than 100-percent open. A device that is not open may or may not be closed.

Closed position: a position that is zero-percent open.

*In process operations, binary instrument signals are commonly either ON or OFF. However, as a more general case, logic systems exist that make use of binary hardware having signals with two alternate real values, e.g., +5 volts and -3 volts. In *positive logic*, the more positive signal, +5 volts, represents the existence of a logic condition, e.g., *pump stopped*. In *negative logic*, the less positive signal, -3 volts, represents the existence of a logic condition of *pump stopped*.

Not-closed position: a position that is more than zero-percent open. A device that is not closed may or may not be open.

Intermediate position: a SPECIFIED position that is greater than zero- and less than 100-percent open.

Not-at-intermediate position: a position that is either above or below the SPECIFIED intermediate position.

For a logic system having an input statement that is derived inferentially or indirectly, a condition may arise that will lead to an erroneous conclusion. For example, an assumption that flow exists because a pump motor is energized may be false because of a closed valve, a broken shaft, or other mishap. Factual statements, that is, statements based on positive measurements that a certain condition specifically exists or does not exist, are generally more reliable.

3.8 A process operation may be affected by loss of the power supply* to memories and to other logic elements. In order to take such operating eventualities into account, it may therefore be necessary to consider the effect of loss of power to any logic component or to the entire logic system. In such cases, it may be necessary to enter power supply or loss of power supply as logic inputs to a system or to individual logic elements. For memories, the consideration of power supply may be handled in this manner or as shown in [Sections 4.7b, c, and d](#).

By the same token, it may be necessary to consider the effect of restoration of power supply.

Logic diagrams do not necessarily have to cover the effect of logic power supplies on process systems but may do so for thoroughness.

3.9 It is recommended, for clarity, that a single time-function symbol, as appropriate, be used to represent each time function in its entirety. Though not incorrect, the representation of a complex or uncommon time function by using a time-function symbol in immediate sequence with a second time-function symbol or with a NOT symbol should be avoided ([see Section 4.8](#)).













3.10 Process instrument symbols and designations follow ISA Standard S5.1-1973 (American National Standards Institute Standard Y32.20-1975), "Instrumentation Symbols and Designations." However, these symbols are included for illustrative purposes, only, and are not part of Standard S5.2.



3.11 If a drawing, or set of drawings, uses graphic symbols that are similar or identical to one another in shape or configuration and that have different meanings because they are taken from different standards, then adequate steps shall be taken to avoid misinterpretation of the symbols used. These steps may be to use caution notes or reference notes, comparison charts that illustrate and define the conflicting symbols, or other suitable means. This requirement is especially critical if the graphic symbols used, being from different disciplines, represent devices, conductors, flow lines, or signals whose symbols, if misinterpreted, may result in danger to personnel or damage to equipment.

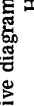

4 Symbols

The symbols for diagramming binary logic are defined as follows:

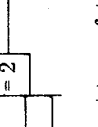
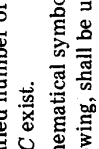
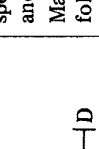
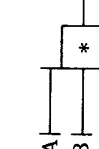
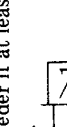
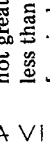

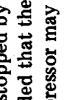
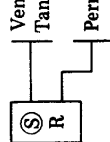

*The term *power supply* covers the energizing medium, whether it be electric, pneumatic, or other.

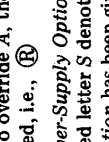

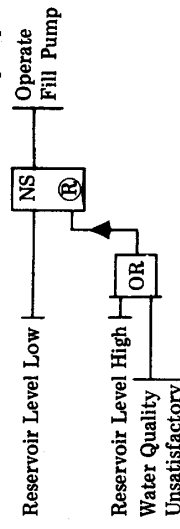
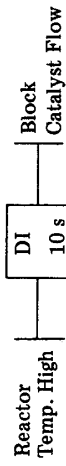
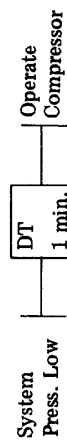
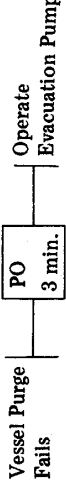
FUNCTION	SYMBOL	DEFINITION	EXAMPLE
4.1 INPUT	<p>Statement of Input</p>  <p>Alternatively:</p>  <p>Initiating instrument or device number, if known</p>	An input to the logic sequence	<p>The start position of a hand switch <i>HS-1</i>, is actuated to provide input to start a conveyor.</p> <p>Alternative diagrams:</p> <p>a) </p> <p>b) </p>
4.2 OUTPUT	<p>Statement of Output</p>  <p>Alternatively:</p>  <p>Operated instrument or device number, if known</p>	An output from the logic sequence.	<p>An output from the logic sequence commands valve <i>HV-2</i> to open.</p> <p>Alternative diagrams:</p> <p>a) </p> <p>b) </p>
4.3 AND	 <p>BASIC</p>	Logic output <i>D</i> exists if and only if all logic inputs <i>A</i> , <i>B</i> , and <i>C</i> exist.	<p>Operate pump if suction tank level is high and discharge valve is open.</p> 
4.4 OR	 <p>BASIC</p>	Logic output <i>D</i> exists if and only if one or more of logic inputs <i>A</i> , <i>B</i> , and <i>C</i> exist.	<p>Stop compressor if cooling water pressure is low or bearing temperature is high.</p> 

FUNCTION	SYMBOL	DEFINITION	EXAMPLE
4.5 QUALIFIED OR	 <p>*Internal details represent numerical quantities (see "Definition").</p>	<p>Logic output <i>D</i> exists if and only if a specified number of logic inputs <i>A</i>, <i>B</i>, and <i>C</i> exist.</p> <p>Mathematical symbols, including the following, shall be used, as appropriate, in specifying the number:</p> <p>a. = equal to b. ≠ not equal to c. < less than d. > greater than e. ≤ not less than f. ≥ not greater than g. ≤ [equivalent to <i>f</i>] h. ≥ [equivalent to <i>e</i>]</p>	<p>a) Operate mixer if two, and only two, bins are in service.</p>  <p>b) Stop reaction if at least two safety devices call for stop.</p>  <p>c) Operate materials feeder if at least one and no more than two mills are in service.</p> 
4.6 NOT	 <p>The <i>NOT</i> symbol may be drawn tangent to an adjacent logic symbol.</p>	<p>Logic output <i>B</i> exists if and only if logic input <i>A</i> does not exist.</p>	<p>Shut off fuel gas if burners no. 1 and no. 2 are not on.</p>  <p>Some Alternatives:</p>  

FUNCTION	SYMBOL	DEFINITION	EXAMPLE
<p>4.7 MEMORY (Flip-Flop)</p>	 <p>a) A B S R C D*</p> <p>*Output D shall not be shown if it is not used.</p>	<p>S represents set memory and R represents reset memory. Logic output C exists as soon as logic input A exists. C continues to exist, regardless of the subsequent state of A, until the memory is reset, i.e., terminated by logic input B existing. C remains terminated regardless of the subsequent state of B, until A causes the memory to be set. Logic output D, if used, exists when C does not exist, and D does not exist when C exists.</p>	<p>If tank pressure becomes high, vent tank and continue venting, regardless of pressure, until venting is stopped by manual actuation of hand switch, HS-1, provided that the pressure is not high. If the venting is stopped, a compressor may be started.</p> 
<p>BASIC</p>	<p>b) A B LS R C D</p> <p>(See Appendix C)</p>	<p><i>Input-Override Option</i></p> <p>If inputs A and B exist simultaneously, and if it is desired to have A override B, then S should be encircled, i.e., \textcircled{S}; if B is to override A, then R should be encircled, i.e., \textcircled{R}.</p> <p><i>Loss-Of-Power-Supply Option</i></p> <p>The unmodified letter S denotes that no consideration has been given to the action of the memory on loss of the logic power supply. See paragraphs 4.7 b, c, and d, below, and 3.8.</p>	<p>If feed begins to flow, the cooler shall operate until the feed tank is empty. In the event of loss of the logic power supply, the cooler shall not operate.</p> 
<p>(cont'd)</p>	<p>c) A B MS R C D</p>	<p>Similar to definition of symbol (a) except that the memory shall be lost in the event of loss of the logic power supply.</p> <p>Similar to definition of symbol (a) except that the memory shall be maintained in the event of loss of the logic power supply.</p>	<p>If standby pump operation is initiated, the pump shall operate, even on loss of the logic power supply, until the process sequence is terminated. The pump shall operate if start and stop commands exist simultaneously.</p> 

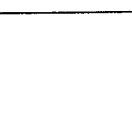
FUNCTION	SYMBOL	DEFINITION	EXAMPLE
4.7 (cont'd)	d) A ——— NS ——— C B ——— R ——— D	Similar to definition of symbol (a) except that <i>after consideration</i> it is deemed <i>not significant</i> , so far as the process is concerned, whether the memory is maintained or lost in the event of loss of power supply.	If reservoir level is low, operate fill pump until either level is high or water quality is unsatisfactory. It is not significant to the process what happens to the pump on loss of the logic supply. If start and stop commands are simultaneous, the pump shall stop. 
4.8 TIME ELEMENT	a) A ——— * ——— B *For functional details, see the following (also see Section 3.9):	Logic output <i>B</i> exists with a time relationship to logic input <i>A</i> as specified.	
BASIC	b) A ——— DI ——— B t	The continuous existence of logic input <i>A</i> for time <i>t</i> causes logic output <i>B</i> to exist when <i>t</i> expires. <i>B</i> terminates when <i>A</i> terminates.	If reactor temperature exceeds a high limit continuously for 10 seconds, block catalyst flow. Resume flow when temperature does not exceed the limit. 
BASIC	c) A ——— DT ——— B t	The existence of logic input <i>A</i> causes logic output <i>B</i> to exist immediately. <i>B</i> terminates when <i>A</i> has terminated and has not again existed for time <i>t</i> .	If system pressure falls below a low limit, operate compressor at once. Stop the compressor when pressure is not low continuously for one minute. 
BASIC (cont'd)	d) A ——— PO ——— B t	The existence of logic input <i>A</i> , regardless of its subsequent state, causes logic output <i>B</i> to exist immediately. <i>B</i> exists for time <i>t</i> and then terminates.	If vessel purge fails for any period of time, operate evacuation pump for 3 minutes and then stop the pump. 

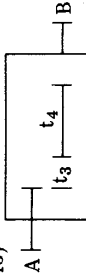
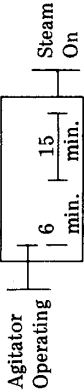
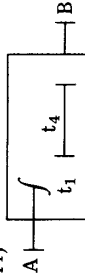
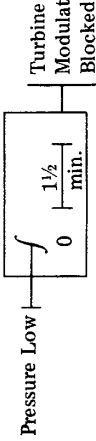
FUNCTION	SYMBOL	DEFINITION	EXAMPLE
4.8 (cont'd)	<p>e1)</p> 	<p>Input logic state exists. Input logic state does not exist. Output logic state exists. Output logic state does not exist.</p> <p>The time at which the logic input A is initiated is represented by the left-hand edge of the box. Passage of time is from left to right and is usually shown unsealed.</p> <p>The logic output B always begins and ends in the same state within the time-element box.</p> <p>More than one output may be shown, if required.</p>	
	<p>e2)</p> 	<p>The timing of logic may be applied to either the existence state or the non-existence state, as applicable.</p> <p>Output logic state exists. Output logic state does not exist.</p>	
	<p>f1)</p> 	<p>The continuous existence of logic input A for time t_1 causes logic output B to exist when t_1 expires. B terminates when A terminates.</p>	<p>Avoid nuisance alarms on high level by actuating alarm only if level remains high continuously for 0.5 second. The alarm signal terminates when there is no high level.</p> 
	<p>f2)</p> 	<p>The continuous existence of logic input A for time t_1 causes logic output B to exist when t_1 expires. B terminates when A has been terminated continuously for time t_2.</p>	<p>Purge immediately with inert gas when combustibles concentration is high. Stop the purge when concentration is not high continuously for 5 minutes.</p> 
(cont'd)			

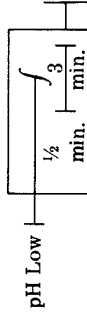
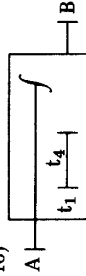
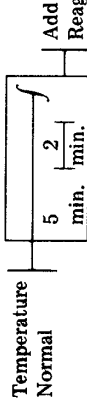
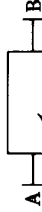
FUNCTION	SYMBOL	DEFINITION	EXAMPLE
4.8 (cont'd)	<p>f3) </p>	<p>The termination of logic input <i>A</i> and its continuous non-existence for time t_3 cause logic output <i>B</i> to exist when t_3 expires. <i>B</i> terminates when either (1) <i>B</i> has existed for time t_4, or (2) <i>A</i> again exists, whichever occurs first.</p>	<p>Steam is turned on for 15 minutes beginning 6 minutes after agitator has stopped except that the steam shall be turned off if the agitator restarts.</p> <p>Agitator Operating </p>
f4)	<p></p>	<p>The existence of logic input <i>A</i>, regardless of its subsequent state, causes logic output <i>B</i> to exist when time t_1 expires. <i>B</i> exists for time t_4 and then terminates.*</p>	<p>If pressure dips to low value momentarily, block modulating control of turbine immediately, maintain for 1½ minutes, then release turbine to modulating control.</p> <p>Pressure Low </p>
f5)	<p></p>	<p>The continuous existence of logic input <i>A</i> for time t_1 causes logic output <i>B</i> to exist when t_1 expires. <i>B</i> exists for time t_4, regardless of the state of <i>A</i>, and then terminates.*</p>	<p>If pH is low continuously for ½ minute, add caustic for 3 minutes.</p> <p>pH Low </p>
f6)	<p></p>	<p>The continuous existence of logic input <i>A</i> for time t_1 causes logic output <i>B</i> to exist when t_1 expires. <i>B</i> terminates when either (1) <i>B</i> has existed for time t_4, or (2) <i>A</i> terminates, whichever occurs first.*</p>	<p>If temperature is normal continuously for 5 minutes, add reagent for 2 minutes except that reagent shall not be added if temperature is abnormal.</p> <p>Temperature Normal </p>
		<p>*For symbols t_4, f_5, and f_6, the action of logic output <i>B</i> depends on how long logic input <i>A</i> is in continuous existence, up to the line break for <i>A</i>. Beyond the break in <i>A</i>, the state of <i>A</i> is not significant to the completion of the <i>B</i> sequence.</p> <p>If it is desired to have a <i>B</i> time segment, e.g., t_1, go to completion only if <i>A</i> exists continuously, then <i>A</i> must be drawn beyond that segment. If <i>A</i> is drawn past the beginning but not beyond the end of a time segment, then the segment will be initiated and go to completion regardless of whether <i>A</i> exists only momentarily or longer.</p>	
4.9 SPECIAL	<p></p> <p>Statement of Special Requirements</p>	<p>Logic output <i>B</i> exists with a relationship to logic input <i>A</i> as specified in the statement of special requirements. The statement may cover a logic function not otherwise specified in this standard or a logic system that is further defined elsewhere.</p>	

5 Bibliography

American National Standards Institute Standard Y32.14-1973, Graphic Symbols for Logic Diagrams (Two-State Devices).

American National Standards Institute Standard X3.5-1970, Flowchart Symbols and Their Usage in Information Processing.

International Electrotechnical Commission Recommendation, Publication 117-15, 1972, Binary Logic Elements.

National Electric Manufacturers Association Standard ICS 1-102, Graphic Symbols for Logic Diagrams.

National Electric Manufacturers Association Standard ICS 1-103, Static Switching Control Devices.

National Fluid Power Association Standard T.3.7.68.2, Graphic Symbols for Fluidic Devices and Circuits.

Appendix A General application example

A.1 Introduction

This example uses a representative process whose instruments are denoted by the symbols of ISA-S5.1-1973, (ANSI Y32.20-1975.) The process equipment symbols are included only to illustrate applications of instrumentation symbols. The example is not a part of Standard S5.2.

A.2 Simplified flow diagram

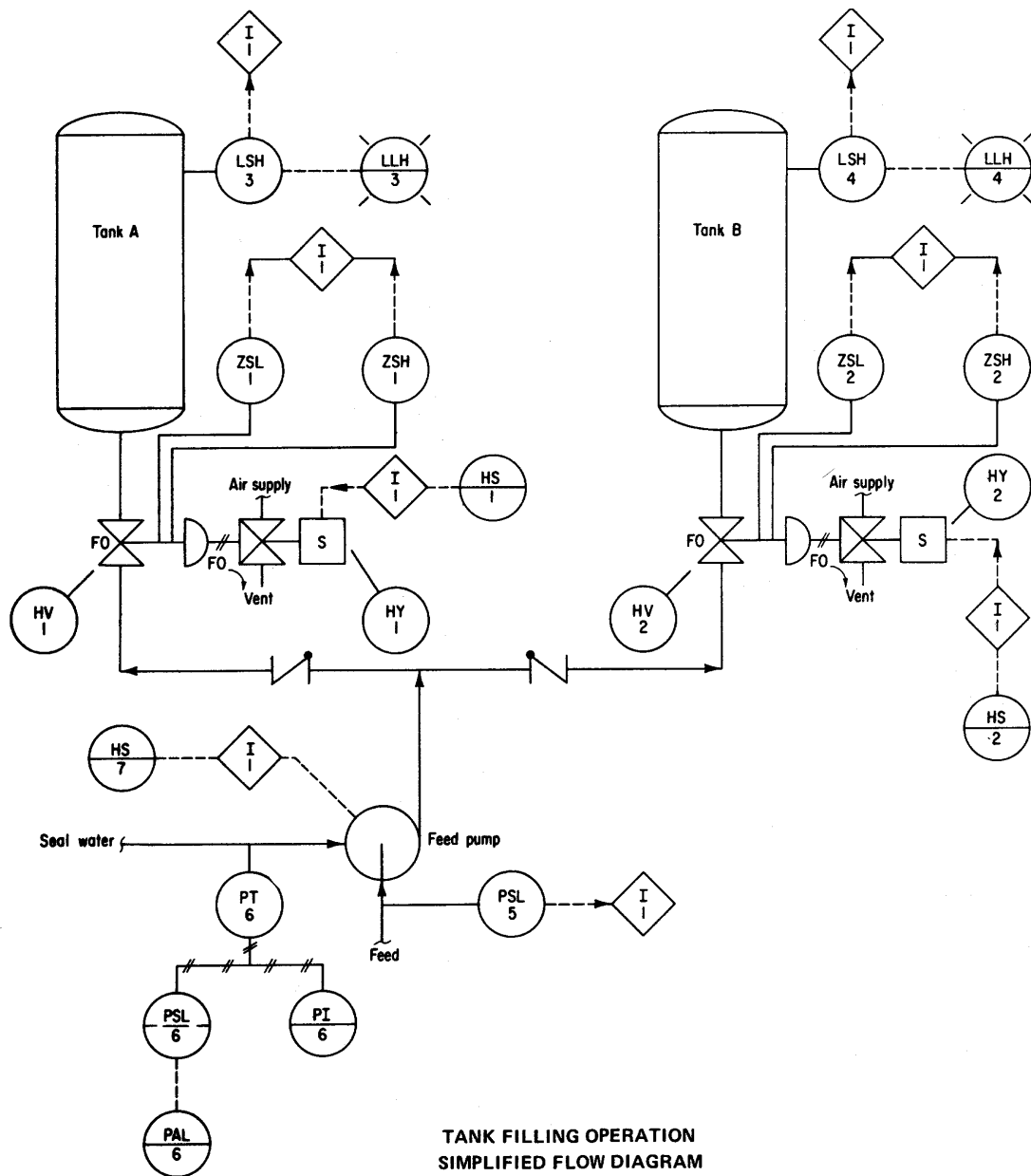

Figure A.1 — Tank filling operation simplified flow diagram

A.3 Word description

A.3.1 Pump start

Feed is pumped into either tank *A* or tank *B*. The pump may be operated manually or automatically, as selected manually on a local maintained-output selector switch, *HS-7*, which has three positions: *ON*, *OFF*, and *AUTO*. When the pump is operating, red pilot light *L-8A* is on; when not operating, green pilot light *L-8B* is on. Once started, the pump continues to operate until a stopping command exists or until the control power supply is lost.

The pump may be operated manually at any time provided that no trouble condition exists: The suction pressure must not be low; the seal water pressure must not be low; and the pump motor must not be overloaded and its starter must be reset.

In order to operate the pump automatically, all the following conditions must be met:

A.3.1.1 Board-mounted electric momentary-contact hand switches, *HS-1* and *HS-2*, start the filling operation for tanks *A* and *B*, respectively. Each switch has two positions, *START* and *STOP*. *START* de-energizes the associated solenoid valves, *HY-1* and *HY-2*. De-energizing a solenoid valve causes it to go to the fail-safe position, i.e., to vent. This depressurizes the pneumatic actuator of the associated control valves, *HV-1* and *HV-2*. Depressurizing a control valve causes it to go to the fail-safe position, i.e., to open. The control valves have associated open-position switches, *ZSH-1* and *ZSH-2*, and closed-position switches, *ZSL-1* and *ZSL-2*.

The *STOP* position of switches *HS-1* and *HS-2* causes the opposite actions to occur so that the solenoid valves are energized, the control valve actuators are pressurized, and the control valves close.

If starting circuit power is lost, the starting memory is lost and the filling operation stops. The command to stop filling can override the command to start filling.

To start the pump automatically, either control valve *HV-1* or *HV-2* must be open and the other control valve must be closed, depending on whether tank *A* or tank *B* is to be filled.

A.3.1.2 The pump suction pressure must be above a given value, as signalled by pressure switch *PSL-5*.

A.3.1.3 If valve *HV-1* is open to permit pumping into tank *A*, the tank level must be below a given value, as signalled by level switch *LSH-3*, which also actuates a board-mounted high-level pilot light, *LLH-3*. Similarly, high-level switch, *LSH-4*, permits pumping into tank *B*, if not actuated, and actuates pilot light *LLH-4*, if actuated.

A.3.1.4 Pump seal water pressure must be adequate, as indicated on board-mounted receiver gage, *PI-6*. This is a non-interlocked requirement that depends on the operator's attention before he starts the operation. Pressure switch, *PSL-6*, behind the board, actuates board-mounted low-pressure alarm, *PAL-6*.

A.3.1.5 The pump drive motor must not be overloaded and its starter must be reset.

A.3.2 Pump stop

The pump stops if any of the following conditions exists:

A.3.2.1 While pumping into a tank, its control valve leaves the fully-open position, or the valve of the other tank leaves its fully-closed position, provided that the pump is on automatic control.

A.3.2.2 The tank selected for filling becomes full, provided that the pump is on automatic control.

A.3.2.3 The pump suction pressure is continuously low for 5 seconds.

A.3.2.4 The pump drive motor is overloaded. It is immaterial to the process logic whether or not the memory of the pump motor overload is retained on loss of power in this system because the maintained memory that operates the pump is defined as losing memory on loss of power, and this by itself will cause the pump to stop. However, an existing motor-overload condition prevents the motor starter from being reset.

A.3.2.5 The sequence is stopped manually through HS-1 or HS-2. If stop and start commands for pump operation exist simultaneously, then the stop command overrides the operate command.

A.3.2.6 The pump is stopped manually by HS-7.

A.3.2.7 The pump seal water pressure is low. This condition is not interlocked, and requires manual intervention to stop the pump.

A.4 Logic diagram

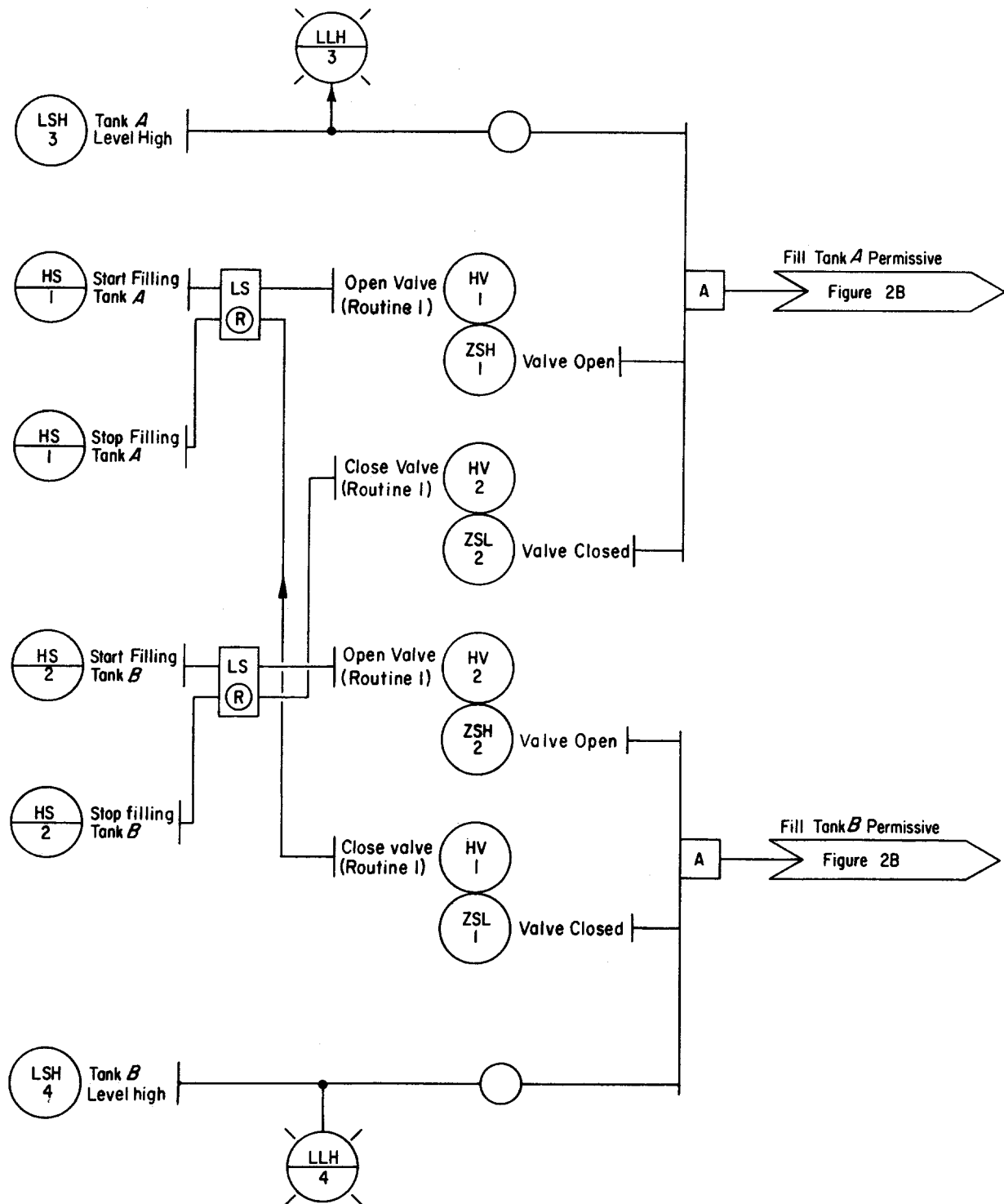

Figure A.2A — Tank filling operation interlock 1 logic diagram — part I

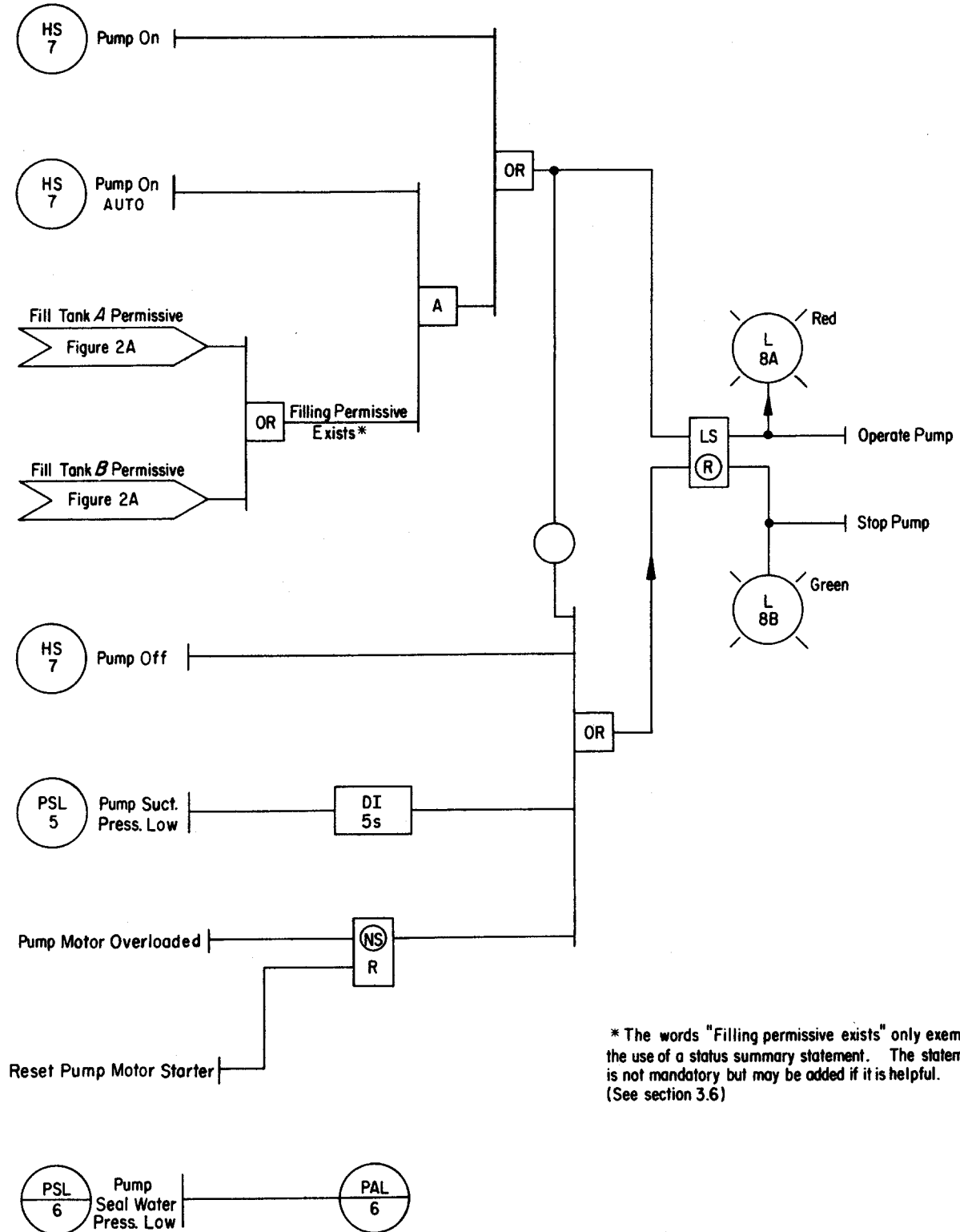

Figure A.2B — Tank filling operation interlock 1 logic diagram — part II

		Solenoid Valve	Control Valve	
		HY-1	HV-1	
		HY-2	HV-2	
			Actuator	Port
Operation	Open Valve	De-Energized	Vented	Open
	Close Valve	Energized	Pressurized	Closed

The information stated in this figure is required if detailed design work is to be done. The information may be presented in any other convenient form.

Description Of Valve Actuation Scheme

Figure A.2C — Tank filling operation interlock 1 routine 1

Comments on the logic diagram for Interlock 1:

- 1) The diagram may be simplified by using general notes (GN) for a project, especially for repetitive items. For example, the operating light for the pump may be omitted from the diagram by using a general note that states: "All pumps have red and green pilot lights to denote that the pump motors are operating or not operating, respectively," thus,

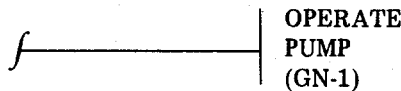

As another example, the motor lockout detail

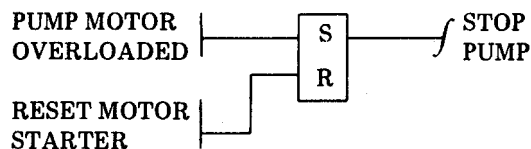

will commonly be simplified by referring to a general note that states: "The motor starter locks out when tripped," thus:



- 2) The memory function that keeps the pumps in operation may be but is not necessarily provided by a circuit breaker for the pump motor. The other maintained-memory functions in the diagram may be provided by pneumatic or electric latching relays or other types of hardware. This illustrates the essentially hardware-free nature of the operational logic portion of the diagram and the emphasis on logic function.

- 3) The logic diagram emphasizes the operating logic of the process by not detailing the system mechanism for opening and closing the control valves. Thus, this information is provided by means of Routine 1, which may apply to similar hardware of an entire project as well as to Interlock 1. However, if it is desired to make the diagram more self-contained by including hardware functions, this can be done as follows, using an excerpt from the diagram as an example:



Alternative:

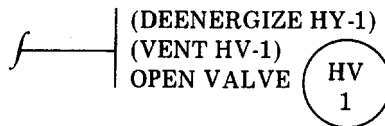

Appendix B Complex time-element example

B.1 Word description

Assume a process operation, as follows:

If air flow becomes high and is so sustained for 4 seconds, then open vent, actuate alarm, and initiate heating by east and west heaters. If heating by east heater is initiated, the heater goes on for 2 seconds, off for one second, and on again for 4 seconds, regardless of whether the air flow remains high while this is occurring. If heating by west heater is initiated, then heater goes on for 30 seconds, off for 18 seconds, and on for 40 seconds, but only if the air flow remains high while this is occurring.

If high flow of air is sustained for 10 seconds, stop the auxiliary blower if it is running.

When air flow is no longer high, close the vent, permit the auxiliary blower to be restarted and the alarm to be reset.

B.2 Logic diagram

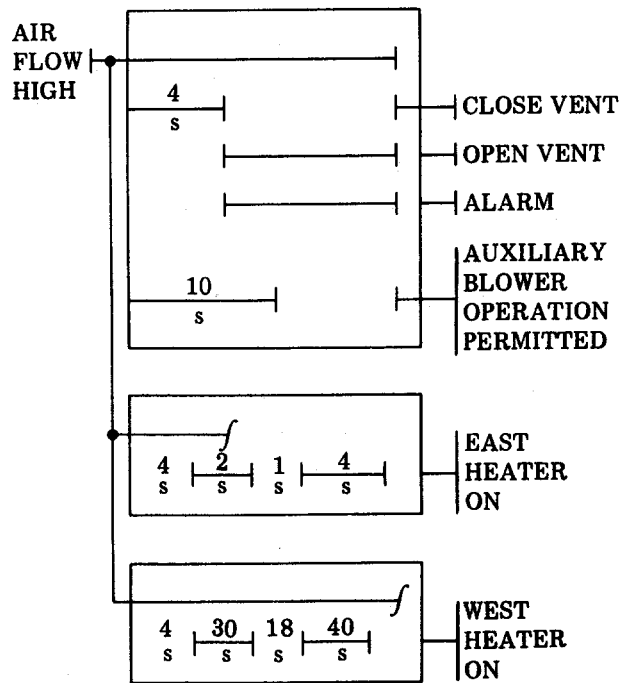

Appendix C Loss of power supply for memory

Section 4.7b indicates how to symbolize memories that are lost in the event of loss of power supply. The use of a logic feedback to symbolize a memory is deprecated. Thus, the following symbolisms shall not be used:

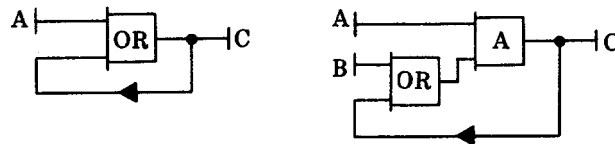

.....



Developing and promulgating technically sound consensus standards, recommended practices, and technical reports is one of ISA's primary goals. To achieve this goal the Standards and Practices Department relies on the technical expertise and efforts of volunteer committee members, chairmen, and reviewers.

ISA is an American National Standards Institute (ANSI) accredited organization. ISA administers United States Technical Advisory Groups (USTAGs) and provides secretariat support for International Electrotechnical Commission (IEC) and International Organization for Standardization (ISO) committees that develop process measurement and control standards. To obtain additional information on the Society's standards program, please write:

**ISA
Attn: Standards Department
67 Alexander Drive
P.O. Box 12277
Research Triangle Park, NC 27709**



ISBN: 0-87664-331-4