

Technical Drawing in Engineering



Lecture 3. Revolution method, fold line method and change of planes

Basics

- **Aim:** Measure true distances and angles (\neq to the projected ones), by **relocating** the elements (that we want to measure) until they are **//** to a projection plane

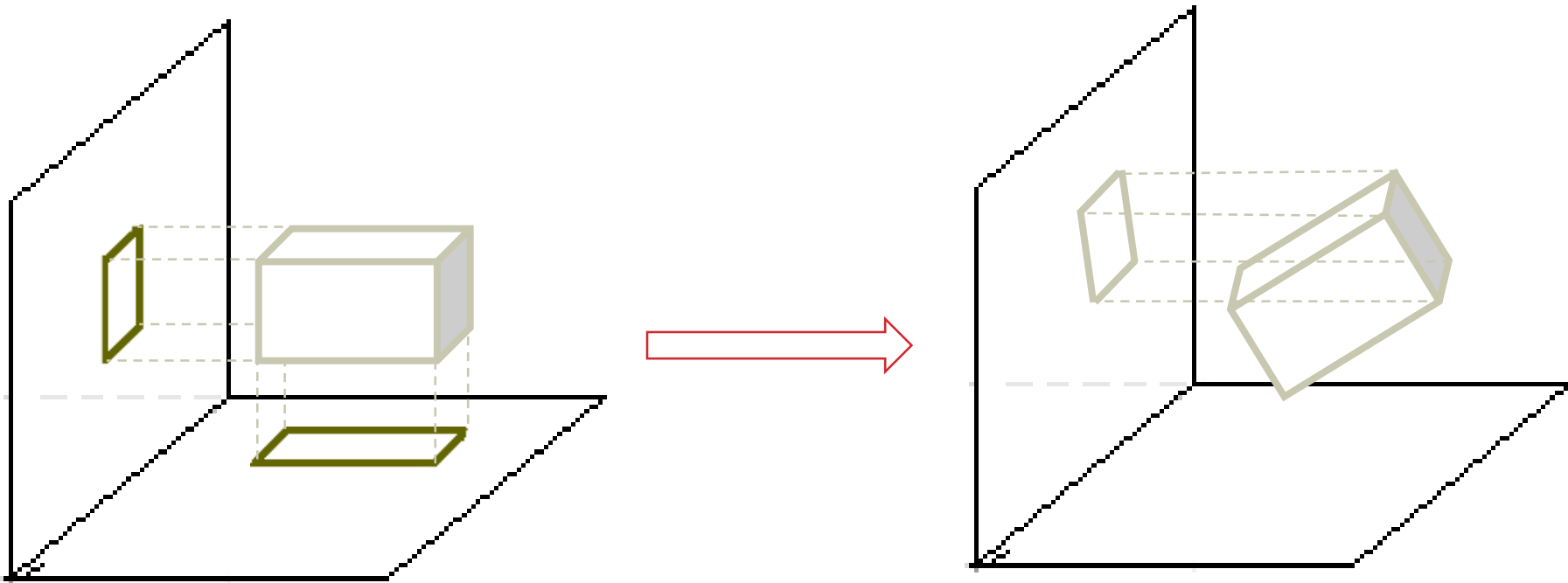

1. Revolution 2. Fold line 3. Change of planes

Revolution

- **Procedure:** Leave the projection planes unchanged and rotate the elements around an axis.

A°

- **Special rotations:** rotations around axes that are perpendicular to the projection planes.



Revolution

- **Procedure:** Leave the projection planes unchanged and rotate the elements around an axis.

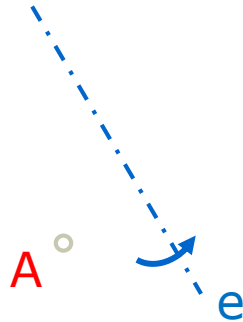

- **Special rotations:** rotations around axes that are perpendicular to the projection planes.



Revolution

- **Procedure:** Leave the projection planes unchanged and rotate the elements around an axis.

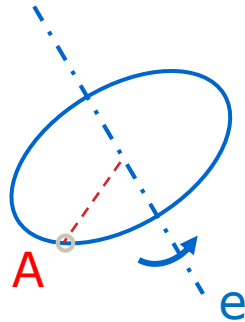

- **Special rotations:** rotations around axes that are perpendicular to the projection planes.



Revolution

- **Procedure:** Leave the projection planes unchanged and rotate the elements around an axis.

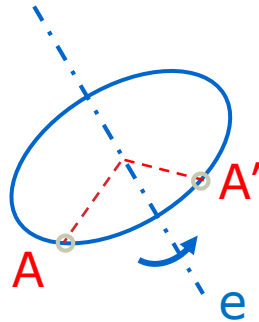

- **Special rotations:** rotations around axes that are perpendicular to the projection planes.



Revolution

- **Procedure:** Leave the projection planes unchanged and rotate the elements around an axis.

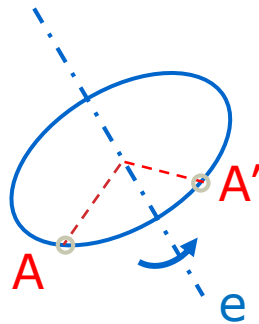

- **Special rotations:** rotations around axes that are perpendicular to the projection planes.

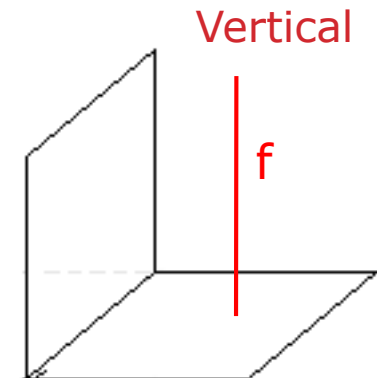
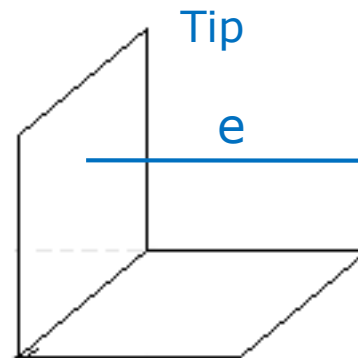
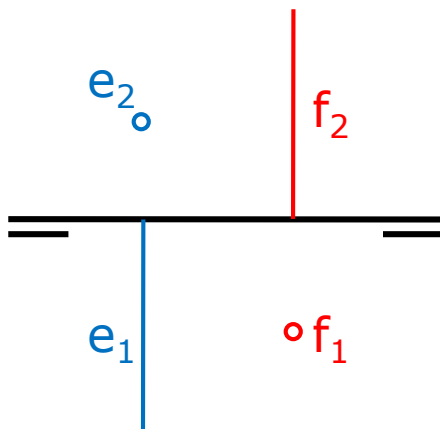

Revolution of a point I

- Revolution of an angle α , axis $e \perp$ horizontal plane H .

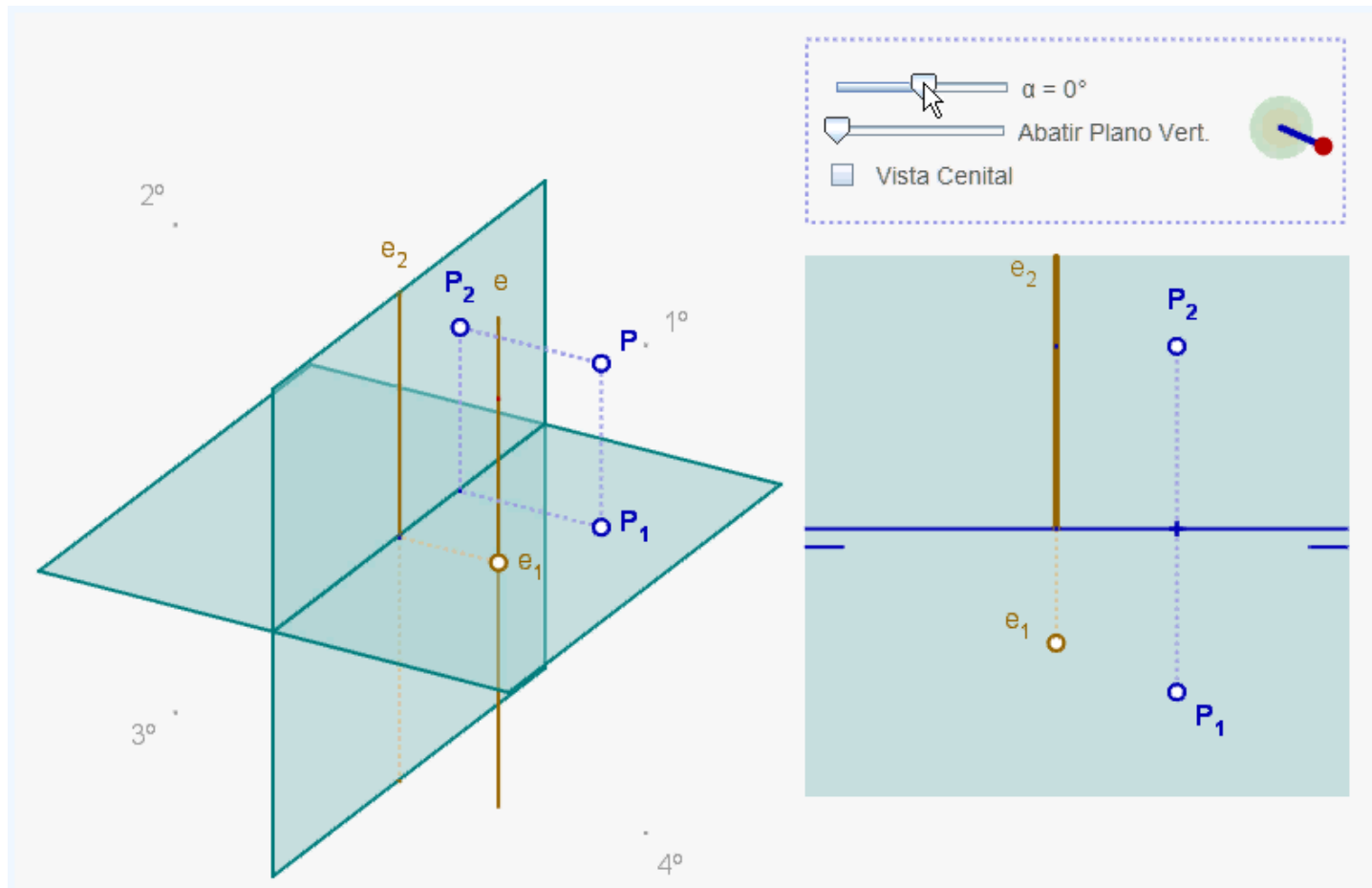

Revolution of a point II

- Revolution of an angle α , axis $e \perp$ horizontal plane H .
 - **Horizontal projection:** $A_1 \rightarrow A'_1$ according to the circular trajectory with centre in e_1 , radius $e_1 A_1$.
 - **Vertical projection:** line through A_2 parallel to R.L.

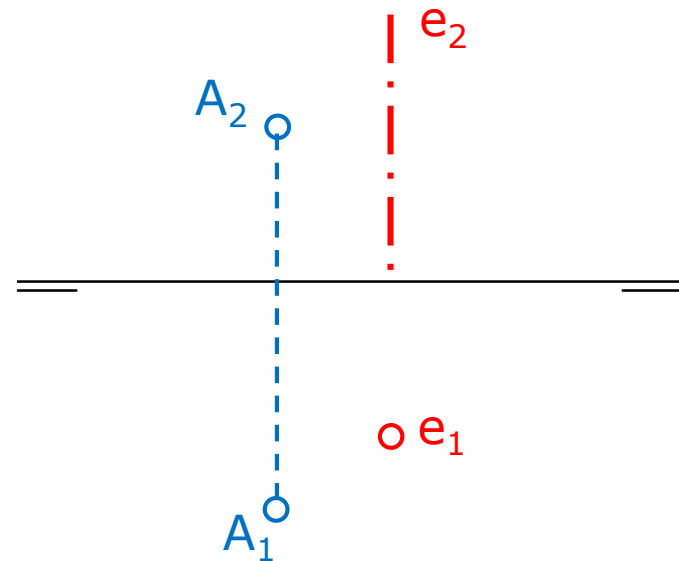
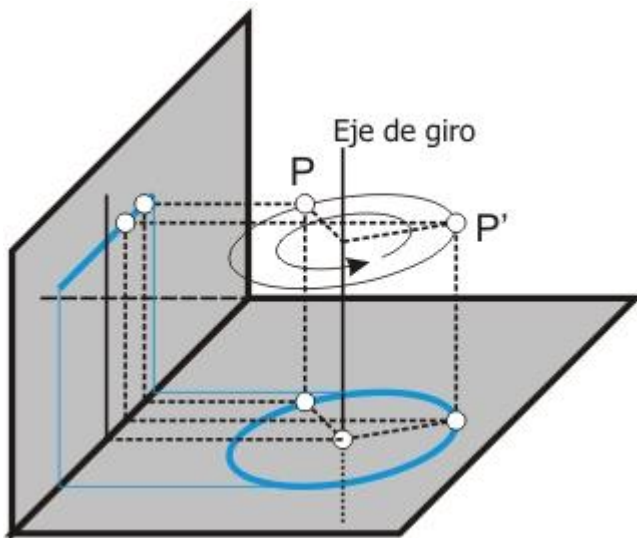

Revolution of a point II

- Revolution of an angle α , axis $e \perp$ horizontal plane H .
 - **Horizontal projection:** $A_1 \rightarrow A'_1$ according to the circular trajectory with centre in e_1 , radius $e_1 A_1$.
 - **Vertical projection:** line through A_2 parallel to R.L.

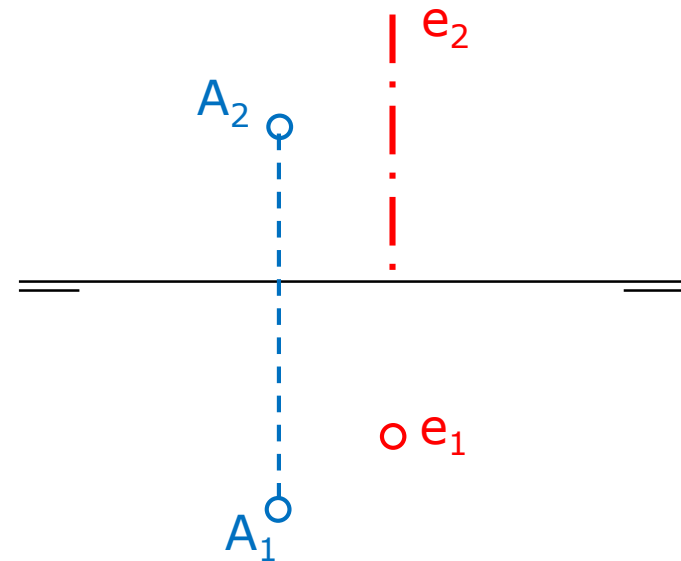
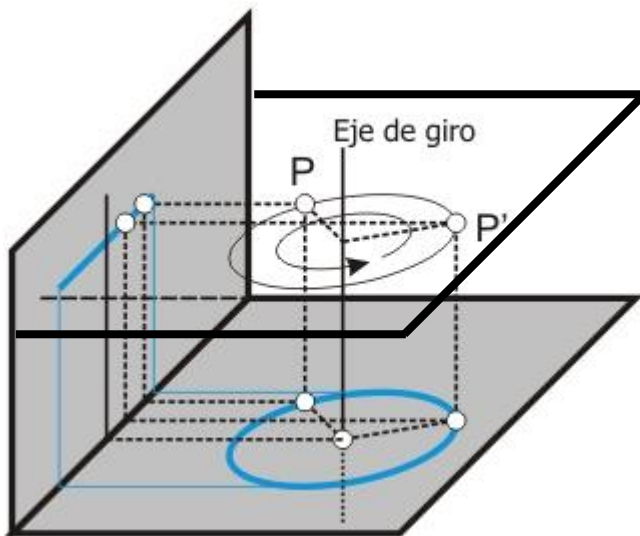

Revolution of a point II

- Revolution of an angle α , axis $e \perp$ horizontal plane H .
 - **Horizontal projection:** $A_1 \rightarrow A'_1$ according to the circular trajectory with centre in e_1 , radius $e_1 A_1$.
 - **Vertical projection:** line through A_2 parallel to R.L.

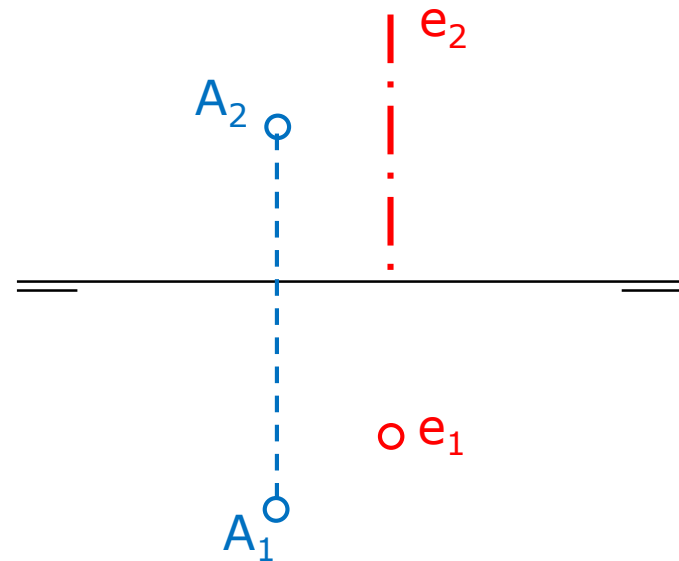
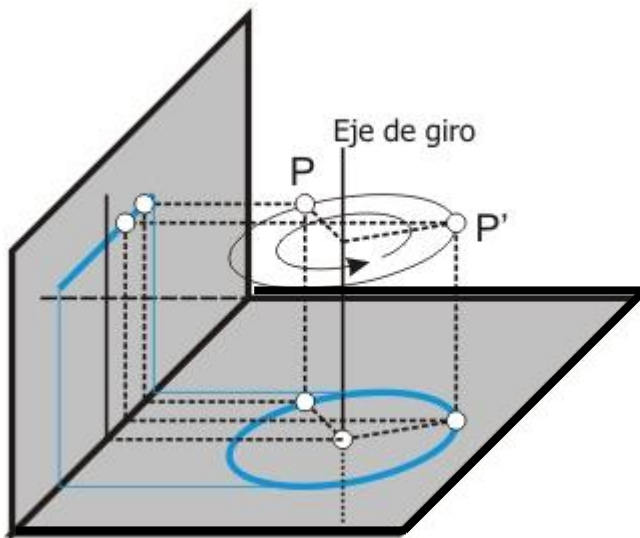

Revolution of a point II

- Revolution of an angle α , axis $e \perp$ horizontal plane H .
 - **Horizontal projection:** $A_1 \rightarrow A'_1$ according to the circular trajectory with centre in e_1 , radius $e_1 A_1$.
 - **Vertical projection:** line through A_2 parallel to R.L.

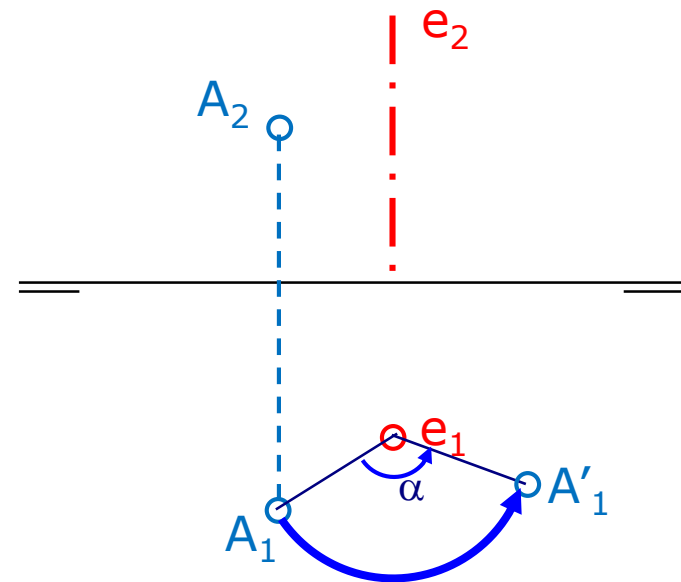
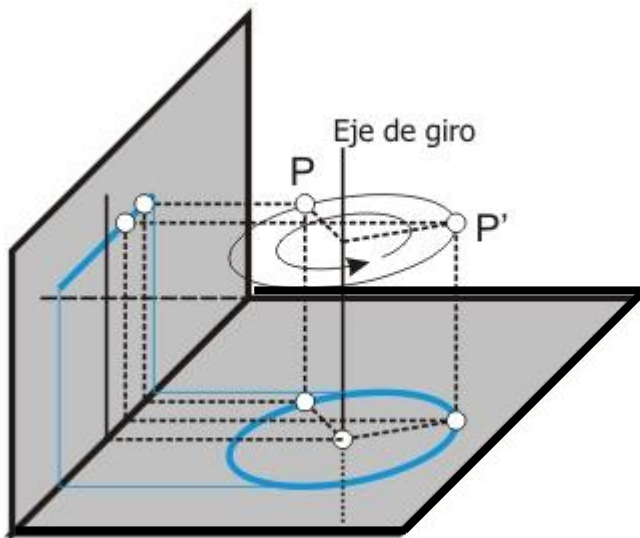

Revolution of a point II

- Revolution of an angle α , axis $e \perp$ horizontal plane H .
 - **Horizontal projection:** $A_1 \rightarrow A'_1$ according to the circular trajectory with centre in e_1 , radius e_1A_1 .
 - **Vertical projection:** line through A_2 parallel to R.L.

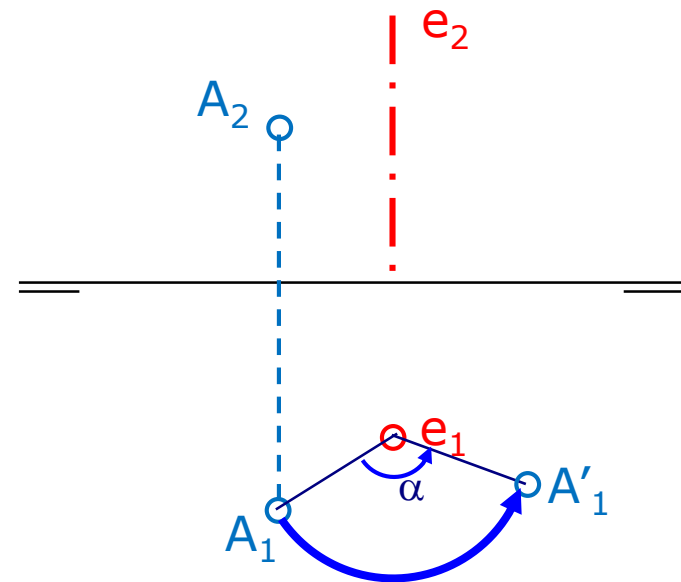
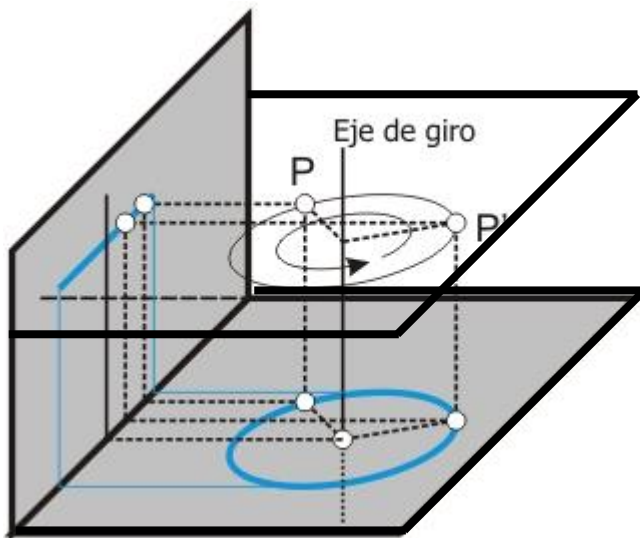

Revolution of a point II

- Revolution of an angle α , axis $e \perp$ horizontal plane H .
 - **Horizontal projection:** $A_1 \rightarrow A'_1$ according to the circular trajectory with centre in e_1 , radius e_1A_1 .
 - **Vertical projection:** line through A_2 parallel to R.L.

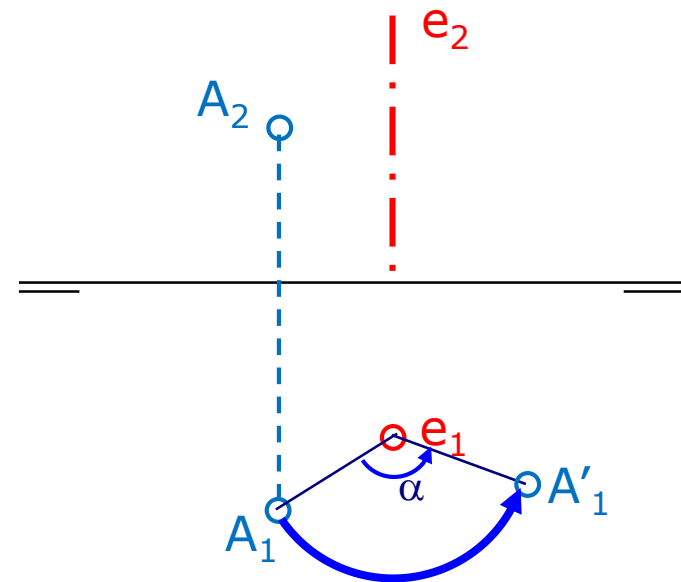
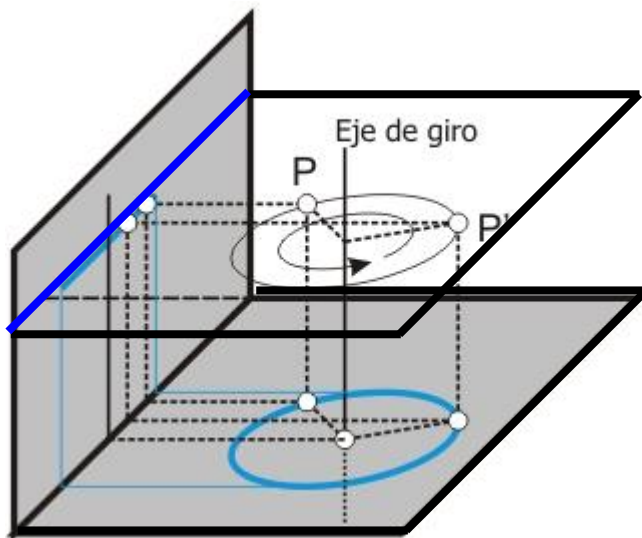

Revolution of a point II

- Revolution of an angle α , axis $e \perp$ horizontal plane H .
 - **Horizontal projection:** $A_1 \rightarrow A'_1$ according to the circular trajectory with centre in e_1 , radius e_1A_1 .
 - **Vertical projection:** line through A_2 parallel to R.L.

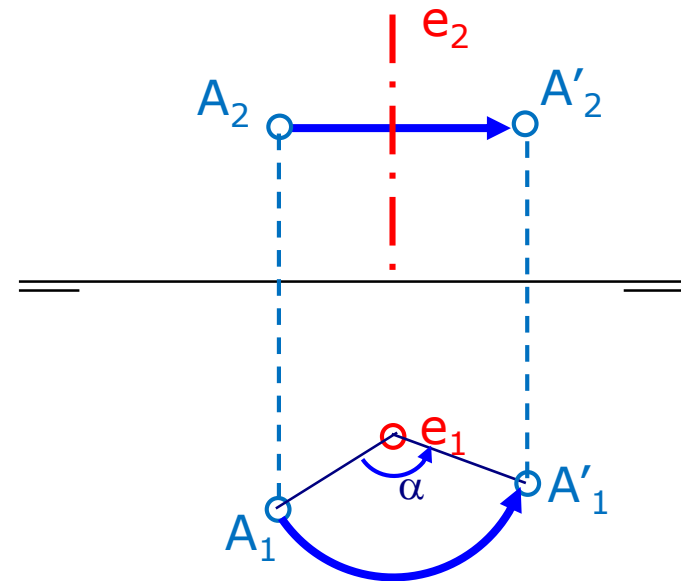
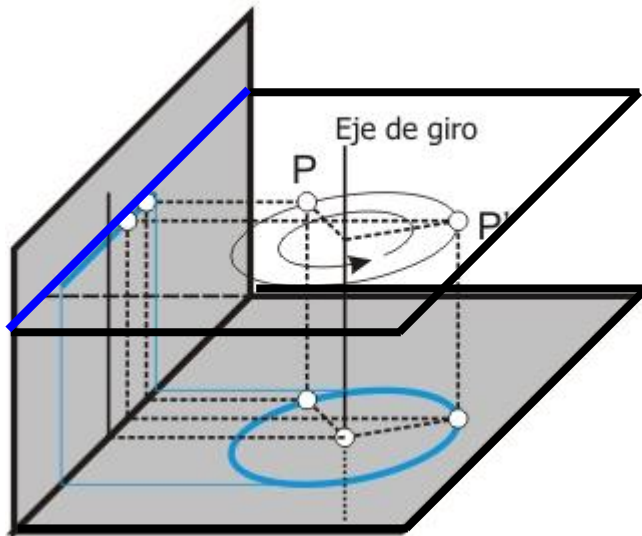

Revolution of a point III

- Revolution of an angle α , axis $e \perp$ vertical plane V .
 - **Vertical projection:** $A_2 \rightarrow A'_2$ according to the circular trajectory with centre in e_2 , radius e_2A_2 .
 - **Horizontal projection:** line through A_1 parallel to

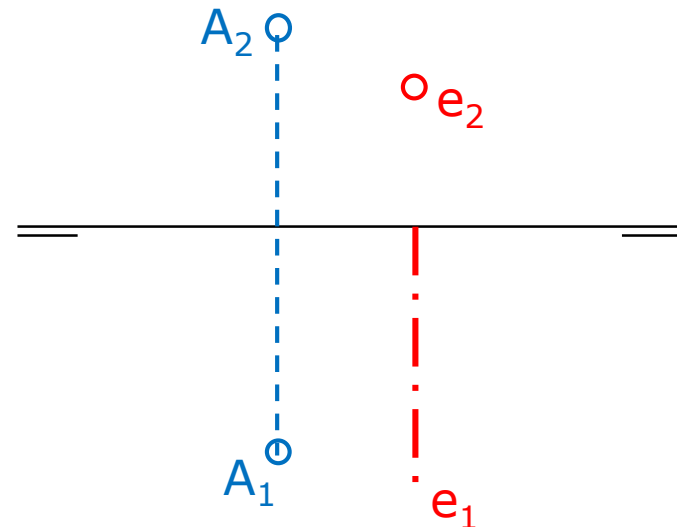
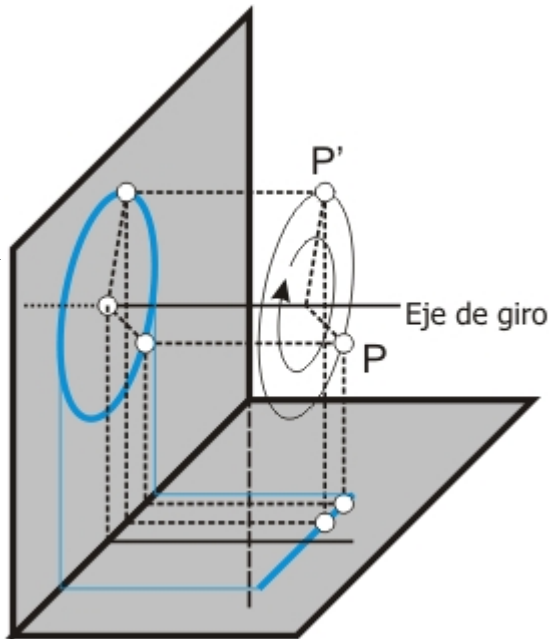

Revolution of a point III

- Revolution of an angle α , axis $e \perp$ vertical plane V .
 - **Vertical projection:** $A_2 \rightarrow A'_2$ according to the circular trajectory with centre in e_2 , radius $e_2 A_2$.
 - **Horizontal projection:** line through A_1 parallel to

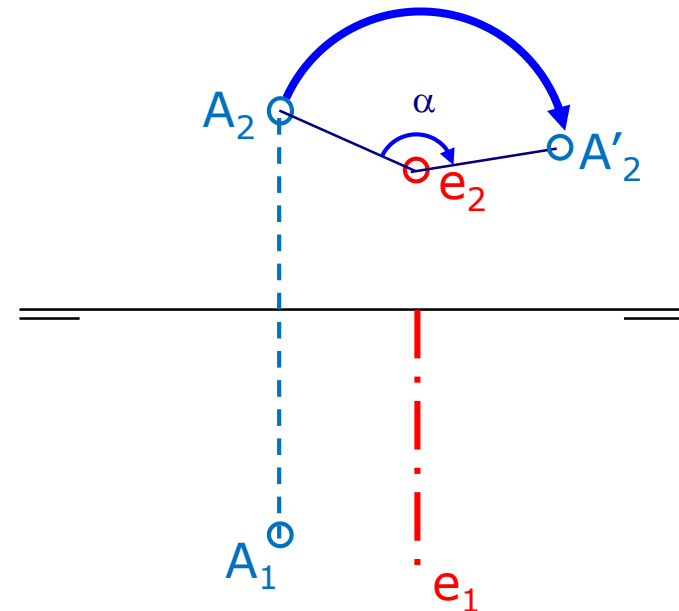
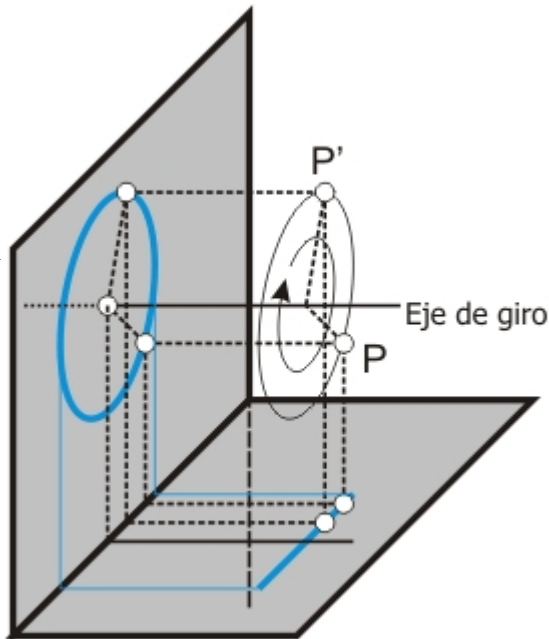

Revolution of a point III

- Revolution of an angle α , axis $e \perp$ vertical plane V .
 - **Vertical projection:** $A_2 \rightarrow A'_2$ according to the circular trajectory with centre in e_2 , radius $e_2 A_2$.
 - **Horizontal projection:** line through A_1 parallel to

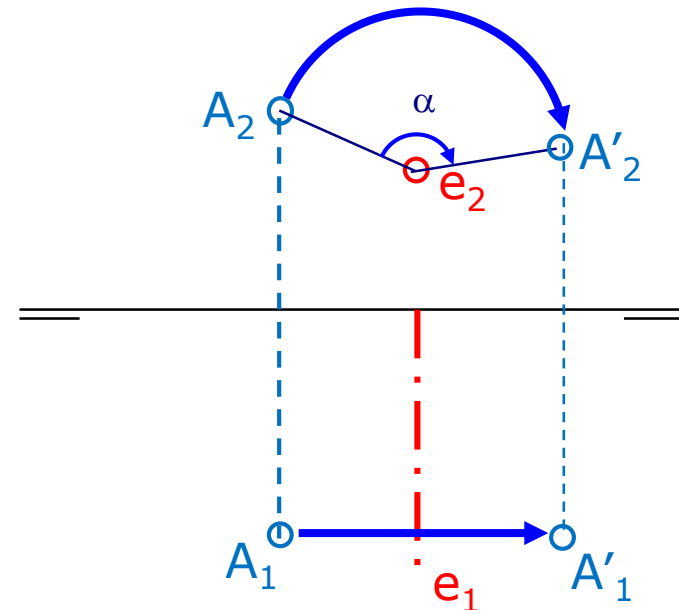
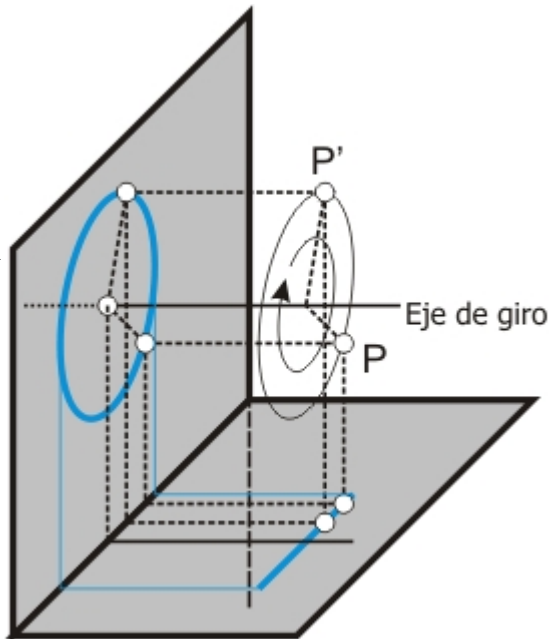

Revolution of a line I

- By rotating two points on the line:

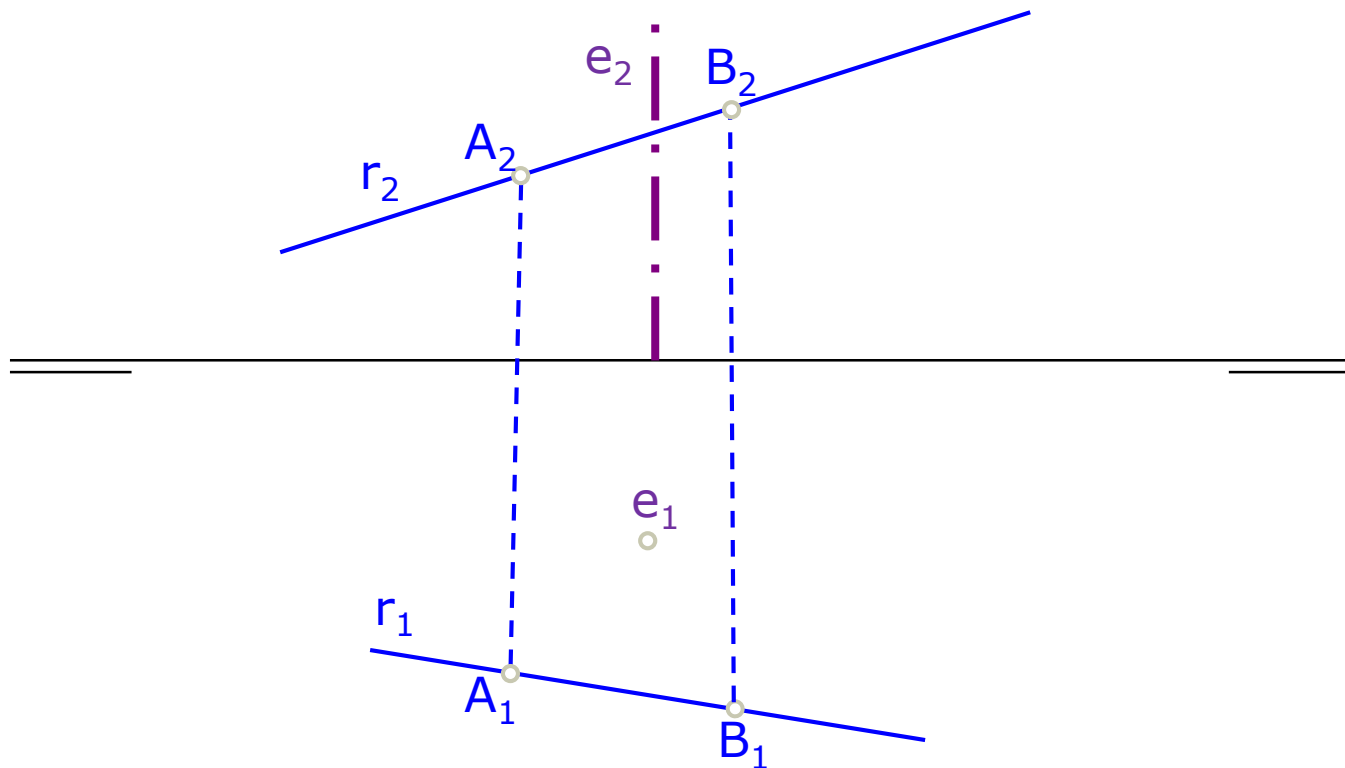

Revolution of a line I

- By rotating two points on the line:

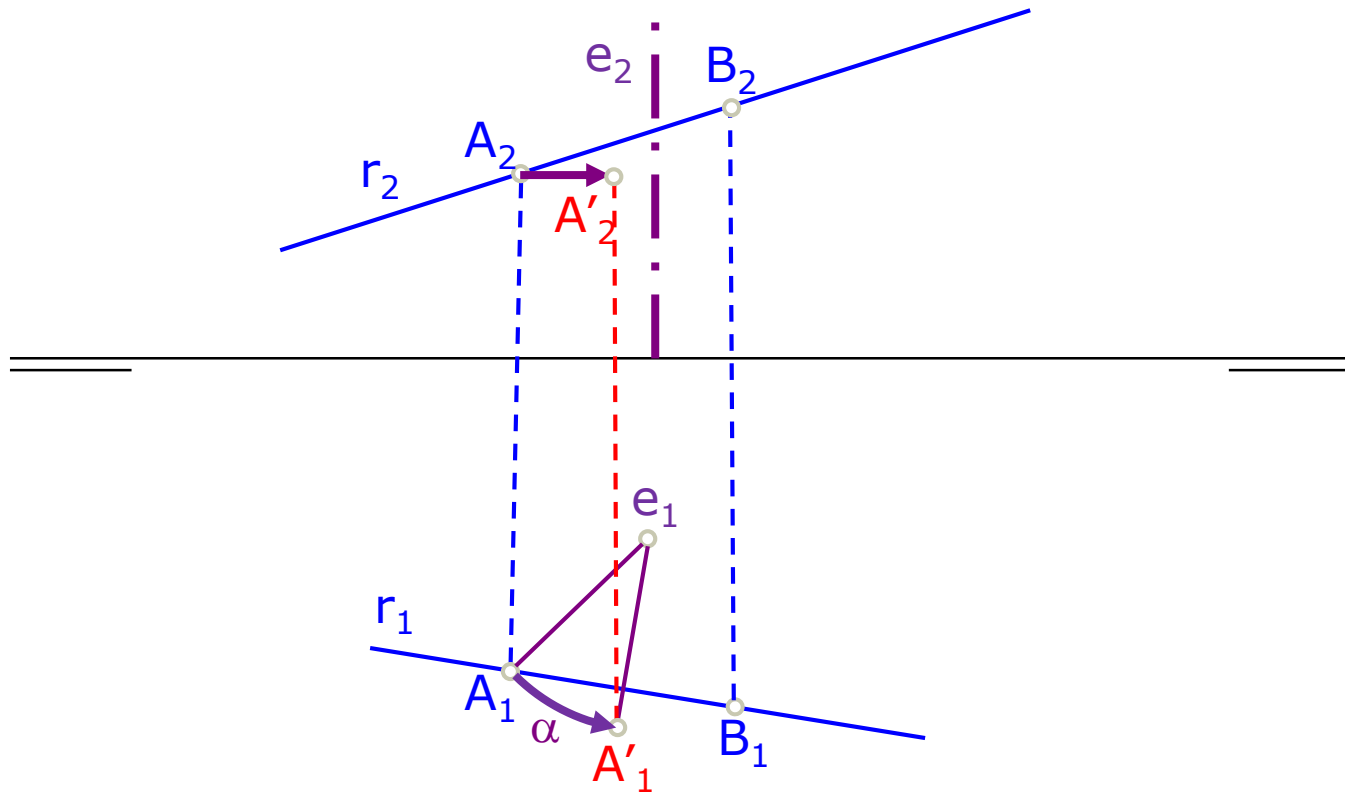

Revolution of a line I

- By rotating two points on the line:

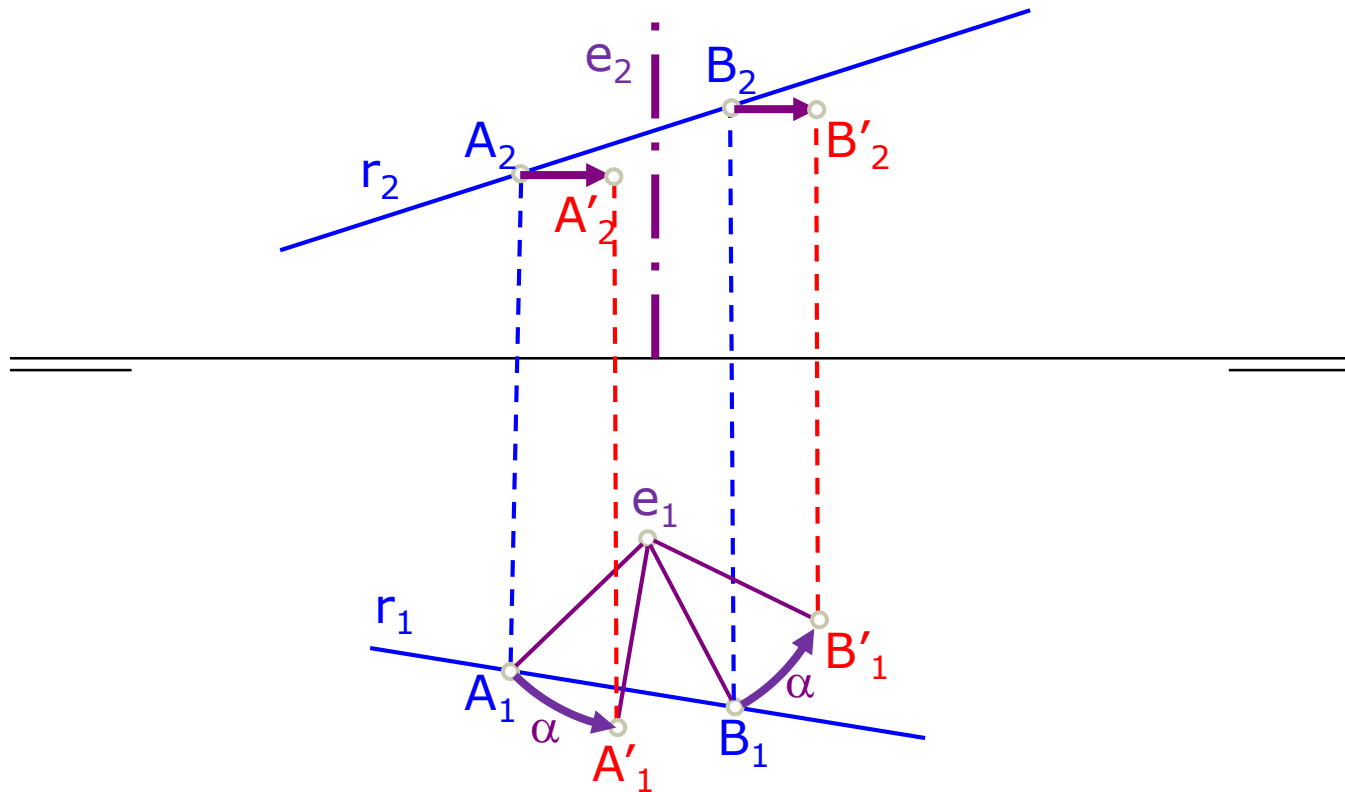

Revolution of a line I

- By rotating two points on the line:

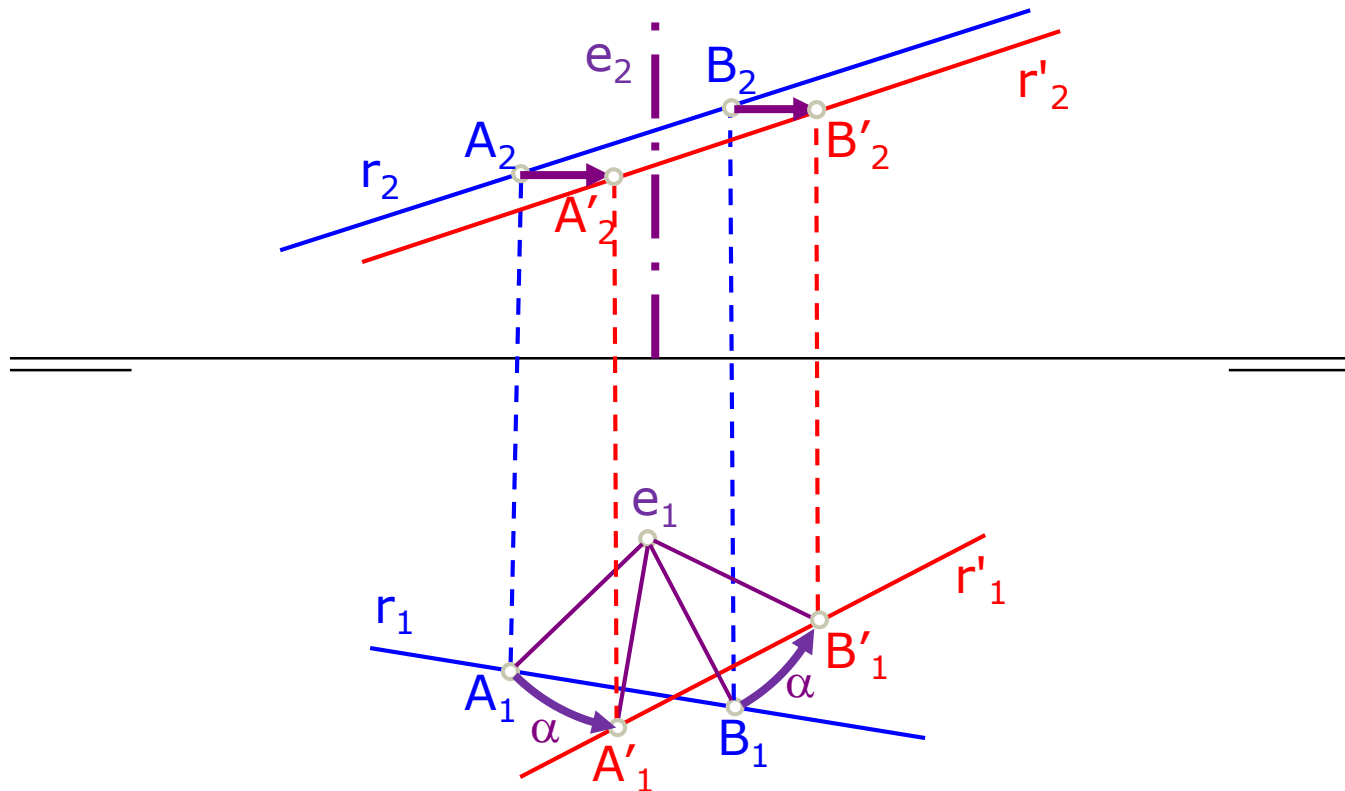

Revolution of a line II

- Transform a line r in a frontal line r' .
 - The axis e intersects with line r and is perpendicular to the horizontal plane H .
 - The intersection point (M) between line r and the axis e doesn't rotate.
 - Rotate a point A of the line r until $r'_1 // RL$, such that, you get $A'(A'_1, A'_2)$ and join A'_2 with M_2 to get r'_2 .

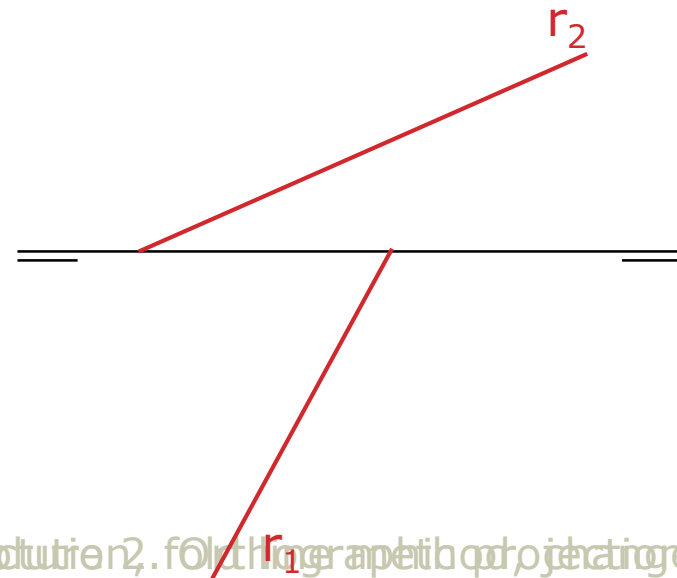
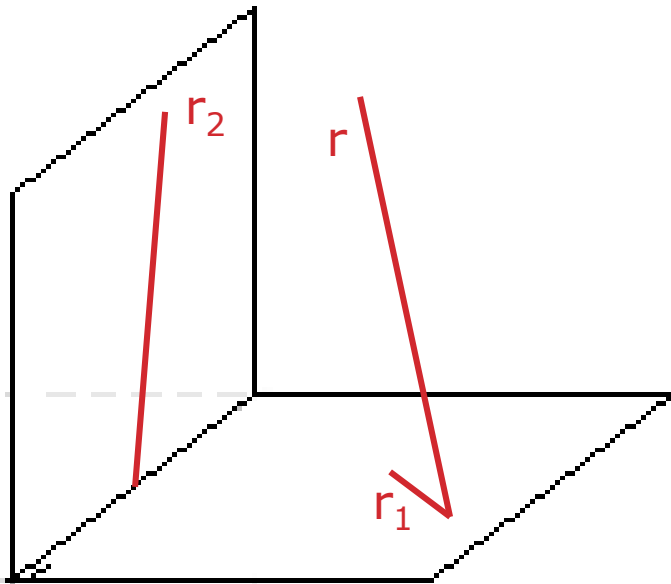

Revolution of a line II

- Transform a line r in a frontal line r' .
 - The axis e intersects with line r and is perpendicular to the horizontal plane H .
 - The intersection point (M) between line r and the axis e doesn't rotate.
 - Rotate a point A of the line r until $r'_1 // RL$, such that, you get $A'(A'_1, A'_2)$ and join A'_2 with M_2 to get r'_2 .

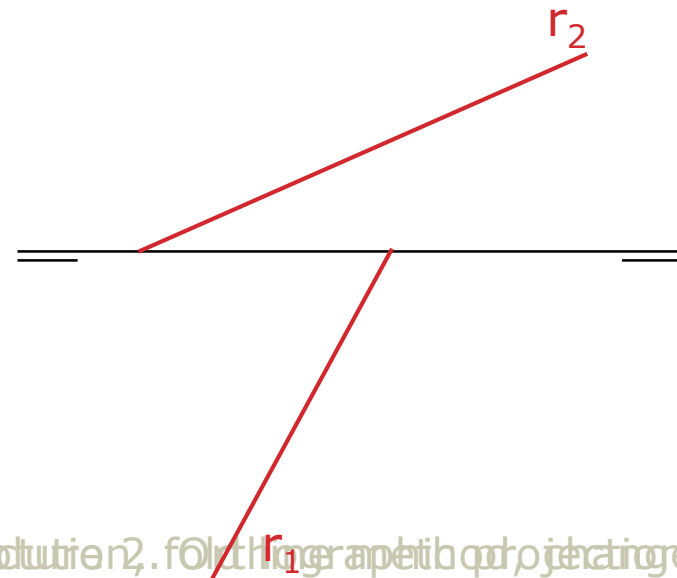
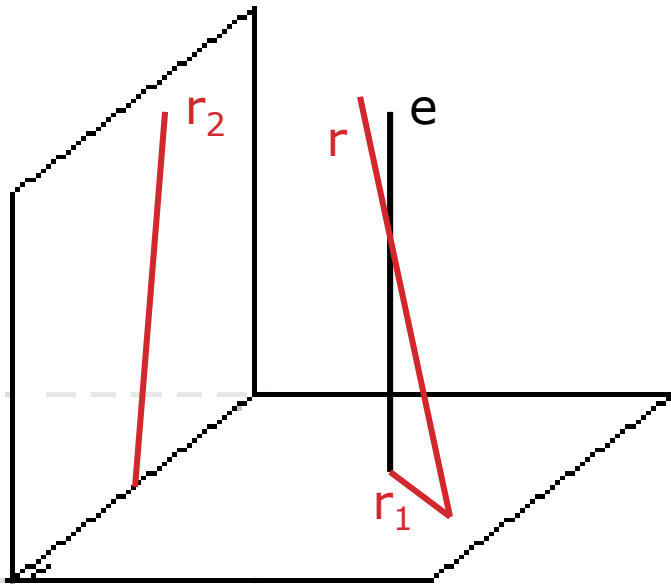

Revolution of a line II

- Transform a line r in a frontal line r' .
 - The axis e intersects with line r and is perpendicular to the horizontal plane H .
 - The intersection point (M) between line r and the axis e doesn't rotate.
 - Rotate a point A of the line r until $r'_1 // RL$, such that, you get $A'(A'_1, A'_2)$ and join A'_2 with M_2 to get r'_2 .

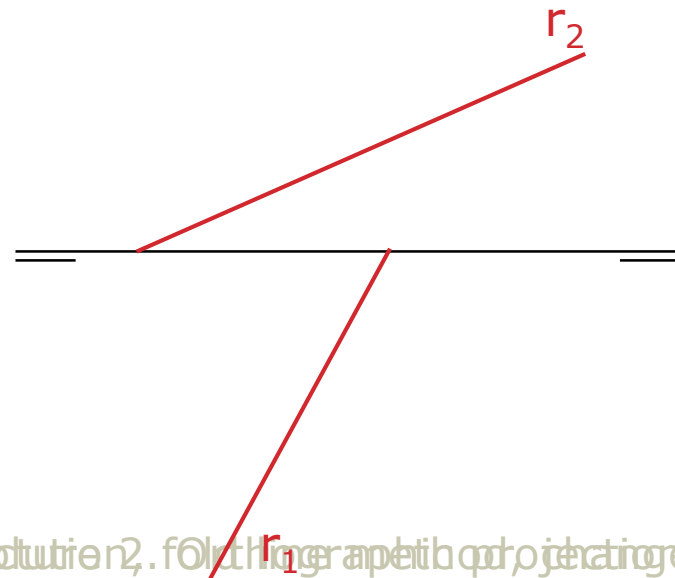
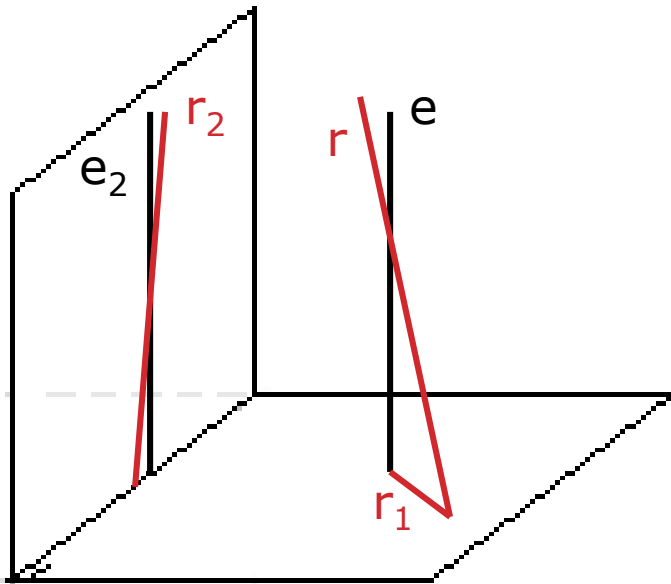

Revolution of a line II

- Transform a line r in a frontal line r' .
 - The axis e intersects with line r and is perpendicular to the horizontal plane H .
 - The intersection point (M) between line r and the axis e doesn't rotate.
 - Rotate a point A of the line r until $r'_1 // RL$, such that, you get $A'(A'_1, A'_2)$ and join A'_2 with M_2 to get r'_2 .

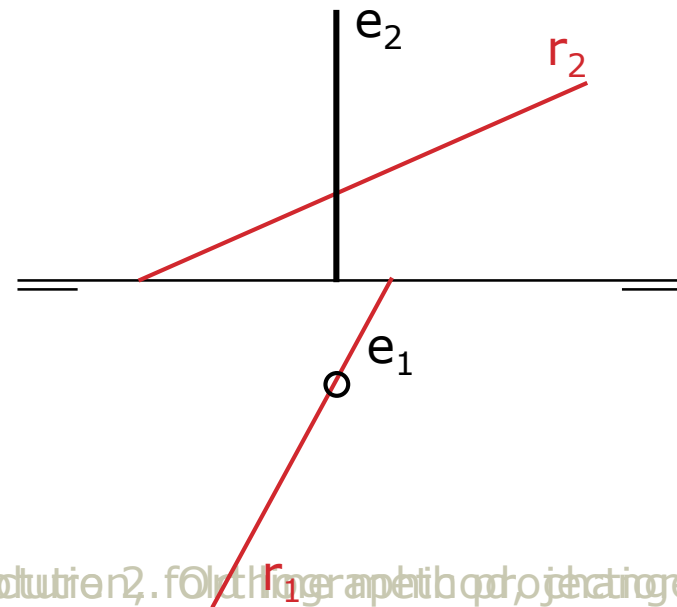
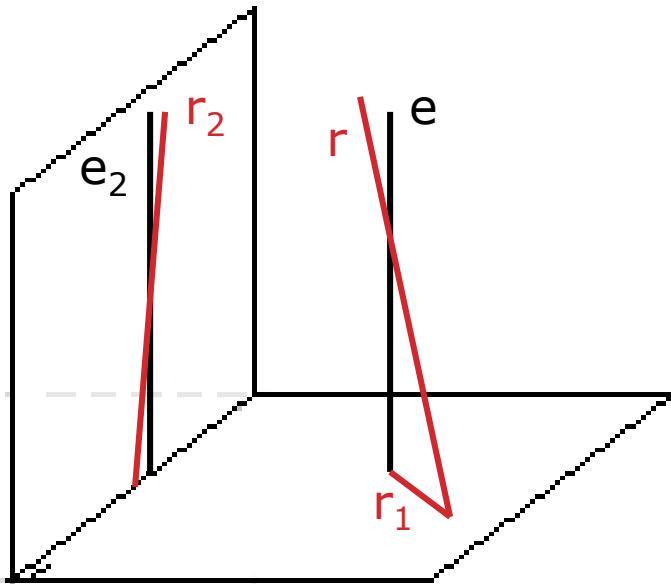

Revolution of a line II

- Transform a line r in a frontal line r' .
 - The axis e intersects with line r and is perpendicular to the horizontal plane H .
 - The intersection point (M) between line r and the axis e doesn't rotate.
 - Rotate a point A of the line r until $r'_1 // RL$, such that, you get $A'(A'_1, A'_2)$ and join A'_2 with M_2 to get r'_2 .

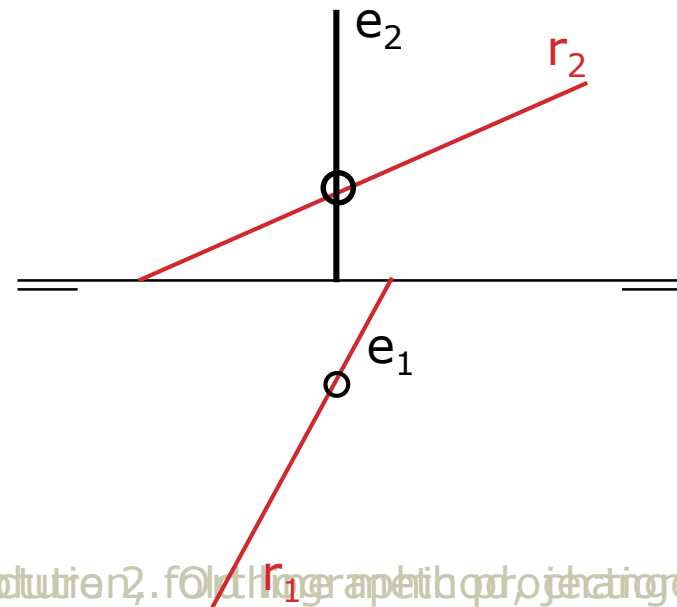
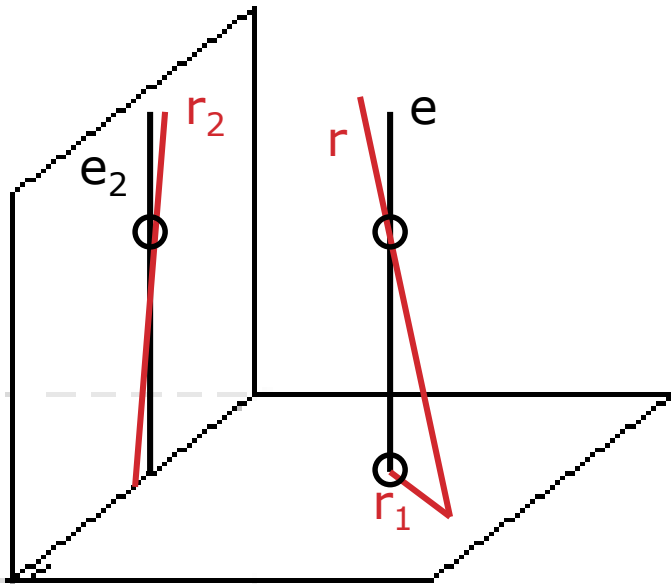

Revolution of a line II

- Transform a line r in a frontal line r' .
 - The axis e intersects with line r and is perpendicular to the horizontal plane H .
 - The intersection point (M) between line r and the axis e doesn't rotate.
 - Rotate a point A of the line r until $r'_1 // RL$, such that, you get $A'(A'_1, A'_2)$ and join A'_2 with M_2 to get r'_2 .

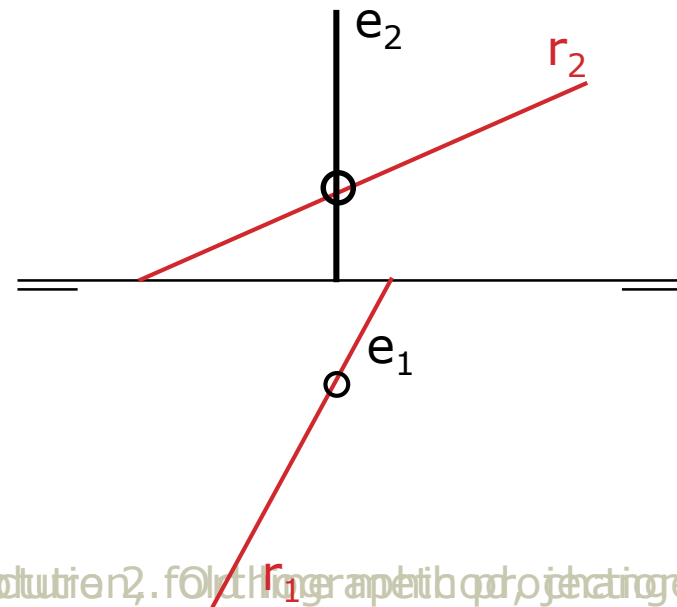
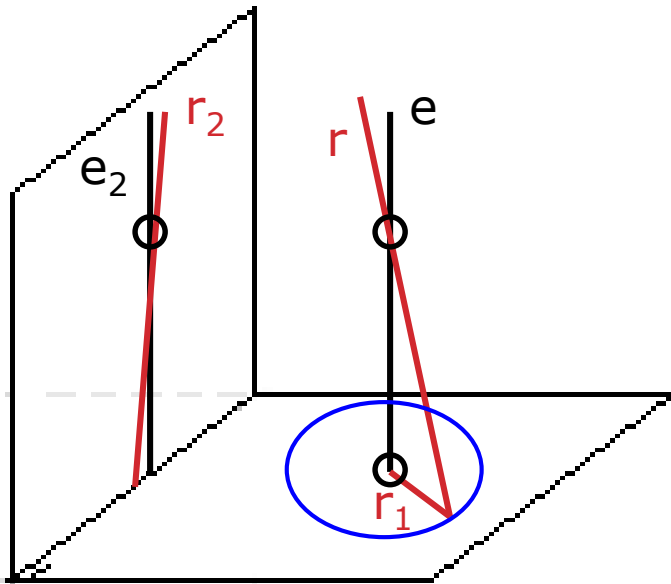

Revolution of a line II

- Transform a line r in a frontal line r' .
 - The axis e intersects with line r and is perpendicular to the horizontal plane H .
 - The intersection point (M) between line r and the axis e doesn't rotate.
 - Rotate a point A of the line r until $r'_1 // RL$, such that, you get $A'(A'_1, A'_2)$ and join A'_2 with M_2 to get r'_2 .

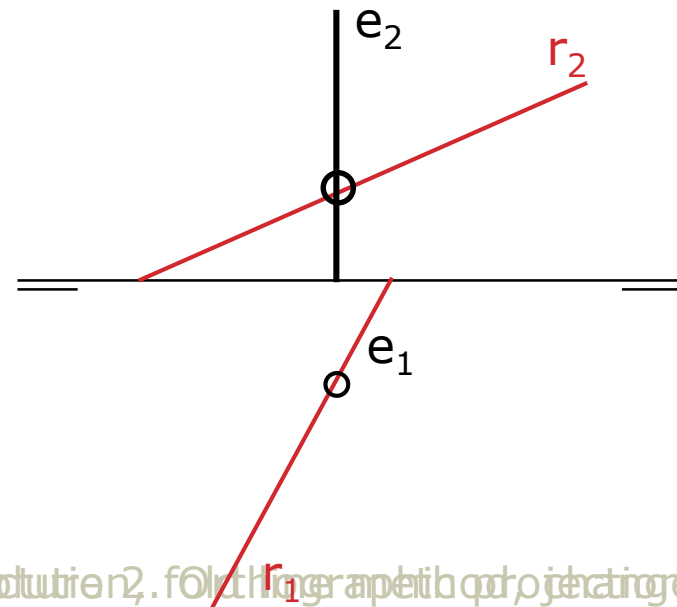
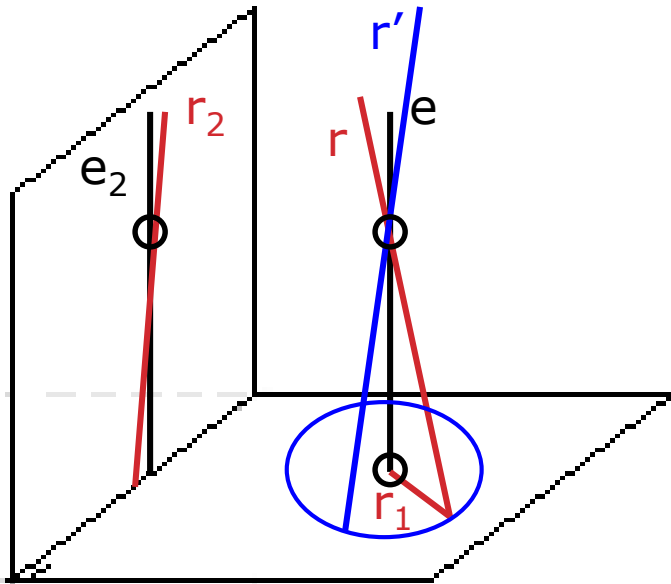

Revolution of a line II

- Transform a line r in a frontal line r' .
 - The axis e intersects with line r and is perpendicular to the horizontal plane H .
 - The intersection point (M) between line r and the axis e doesn't rotate.
 - Rotate a point A of the line r until $r'_1 // RL$, such that, you get $A'(A'_1, A'_2)$ and join A'_2 with M_2 to get r'_2 .

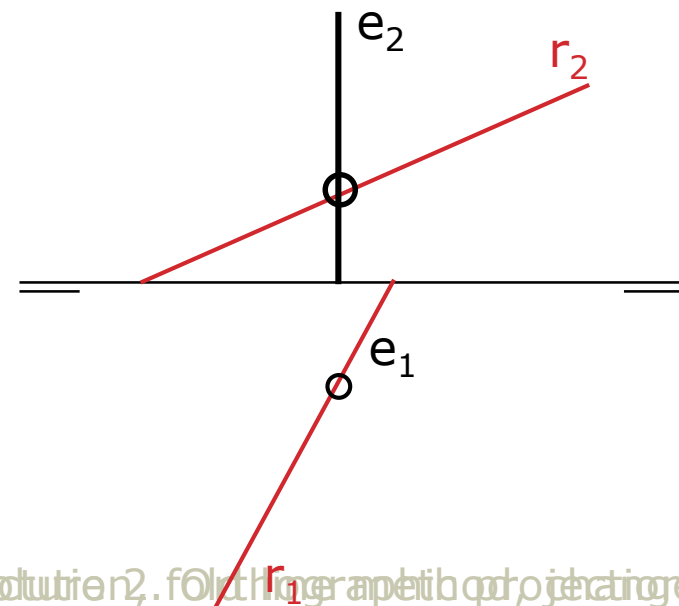
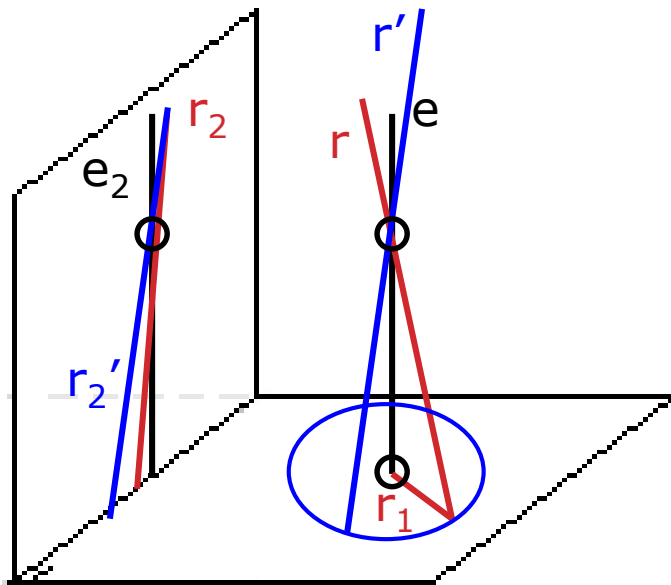

Revolution of a line II

- Transform a line r in a frontal line r' .
 - The axis e intersects with line r and is perpendicular to the horizontal plane H .
 - The intersection point (M) between line r and the axis e doesn't rotate.
 - Rotate a point A of the line r until $r'_1 // RL$, such that, you get $A'(A'_1, A'_2)$ and join A'_2 with M_2 to get r'_2 .

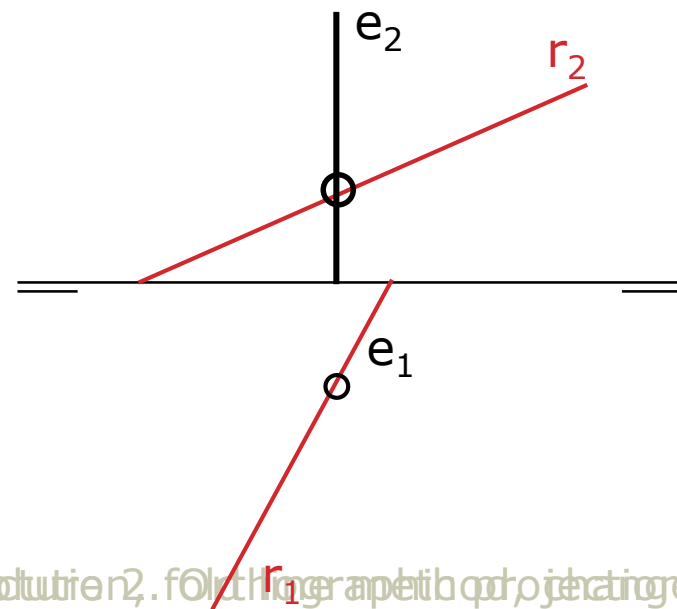
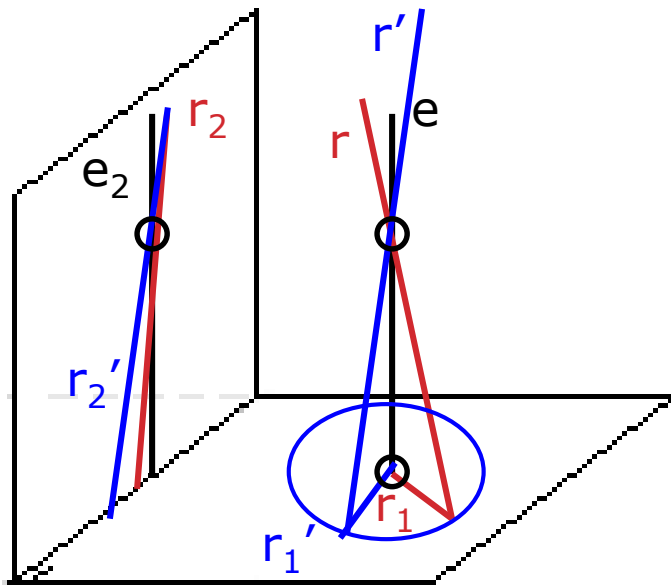

Revolution of a line II

- Transform a line r in a frontal line r' .
 - The axis e intersects with line r and is perpendicular to the horizontal plane H .
 - The intersection point (M) between line r and the axis e doesn't rotate.
 - Rotate a point A of the line r until $r'_1 // RL$, such that, you get $A'(A'_1, A'_2)$ and join A'_2 with M_2 to get r'_2 .

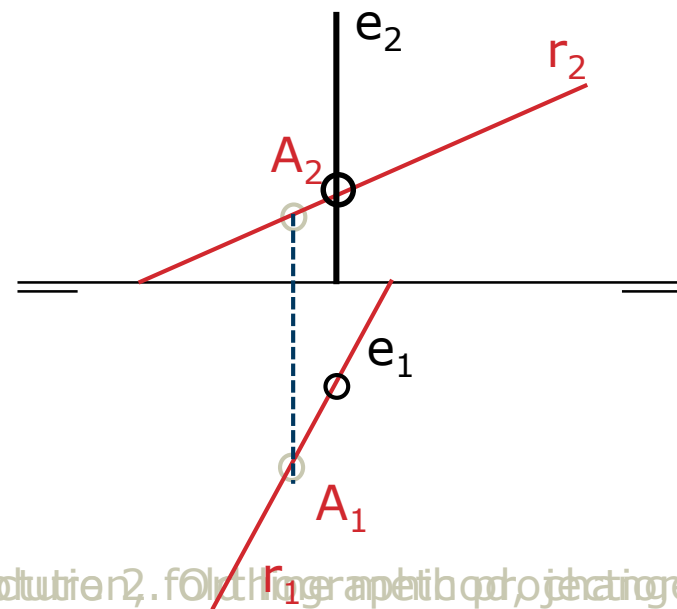
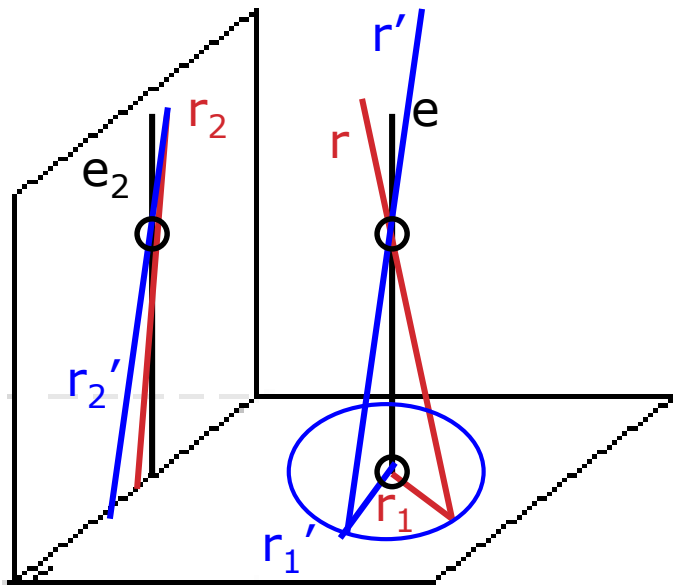

Revolution of a line II

- Transform a line r in a frontal line r' .
 - The axis e intersects with line r and is perpendicular to the horizontal plane H .
 - The intersection point (M) between line r and the axis e doesn't rotate.
 - Rotate a point A of the line r until $r'_1 // RL$, such that, you get $A'(A'_1, A'_2)$ and join A'_2 with M_2 to get r'_2 .

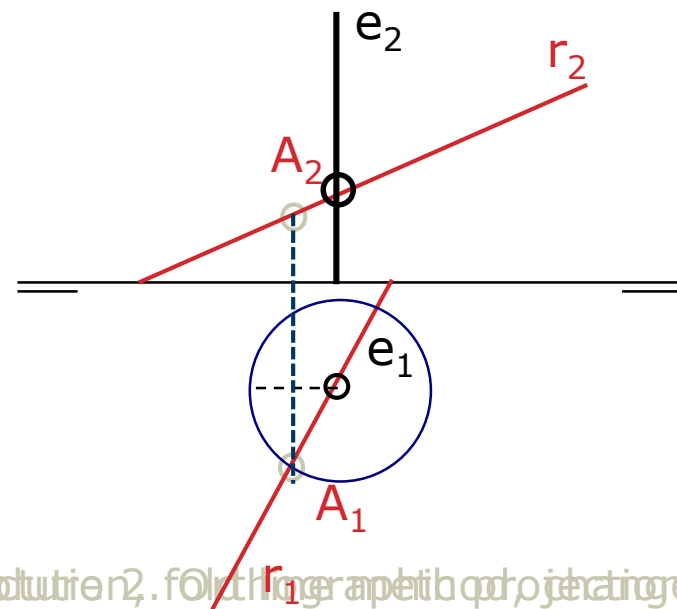
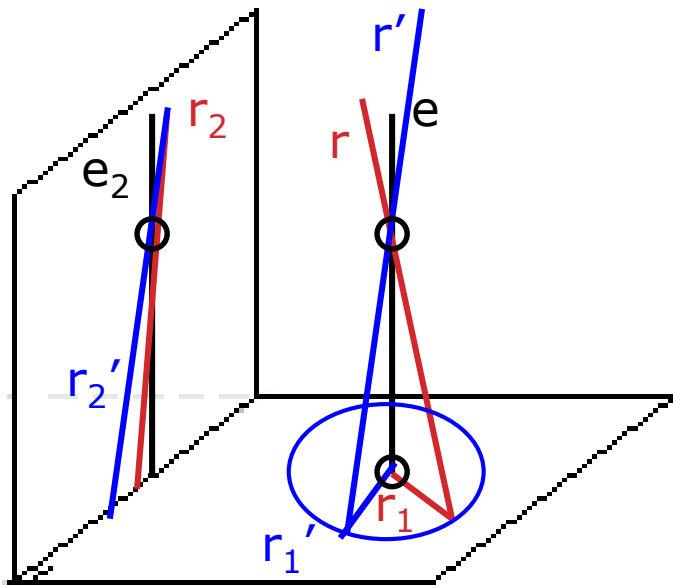

Revolution of a line II

- Transform a line r in a frontal line r' .
 - The axis e intersects with line r and is perpendicular to the horizontal plane H .
 - The intersection point (M) between line r and the axis e doesn't rotate.
 - Rotate a point A of the line r until $r'_1 // RL$, such that, you get $A'(A'_1, A'_2)$ and join A'_2 with M_2 to get r'_2 .

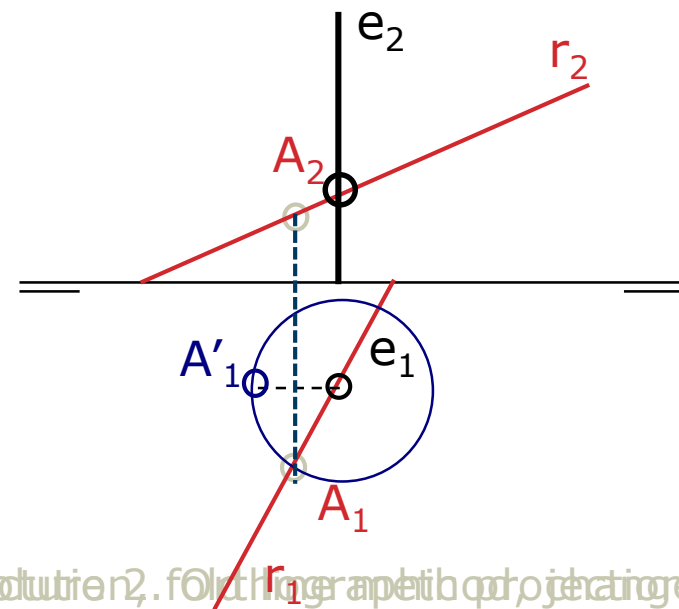
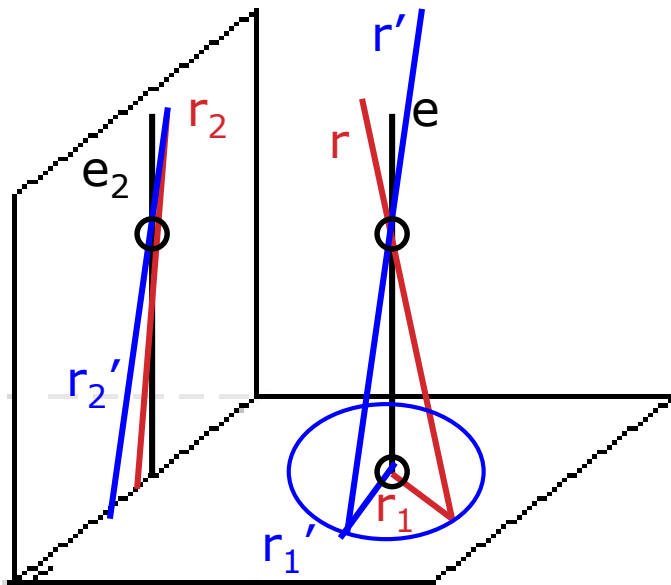

Revolution of a line II

- Transform a line r in a frontal line r' .
 - The axis e intersects with line r and is perpendicular to the horizontal plane H .
 - The intersection point (M) between line r and the axis e doesn't rotate.
 - Rotate a point A of the line r until $r'_1 // RL$, such that, you get $A'(A'_1, A'_2)$ and join A'_2 with M_2 to get r'_2 .

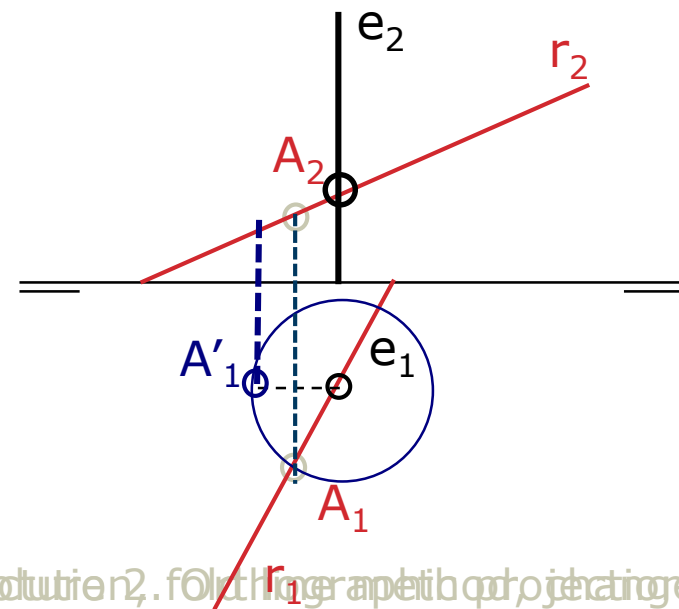
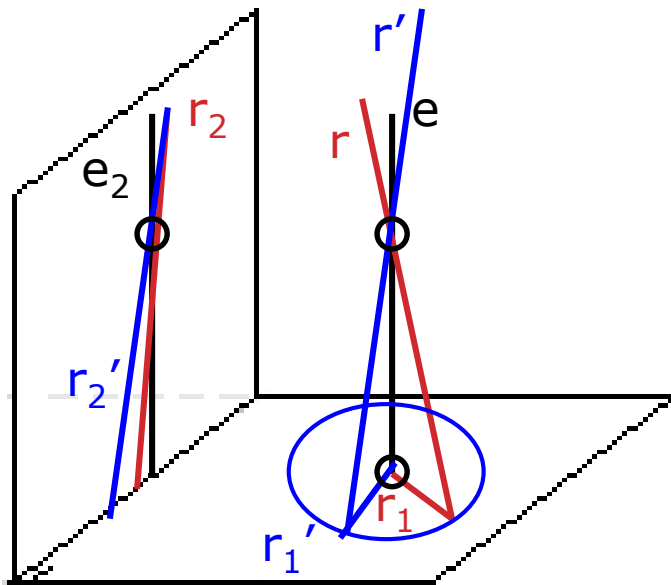

Revolution of a line II

- Transform a line r in a frontal line r' .
 - The axis e intersects with line r and is perpendicular to the horizontal plane H .
 - The intersection point (M) between line r and the axis e doesn't rotate.
 - Rotate a point A of the line r until $r'_1 // RL$, such that, you get $A'(A'_1, A'_2)$ and join A'_2 with M_2 to get r'_2 .

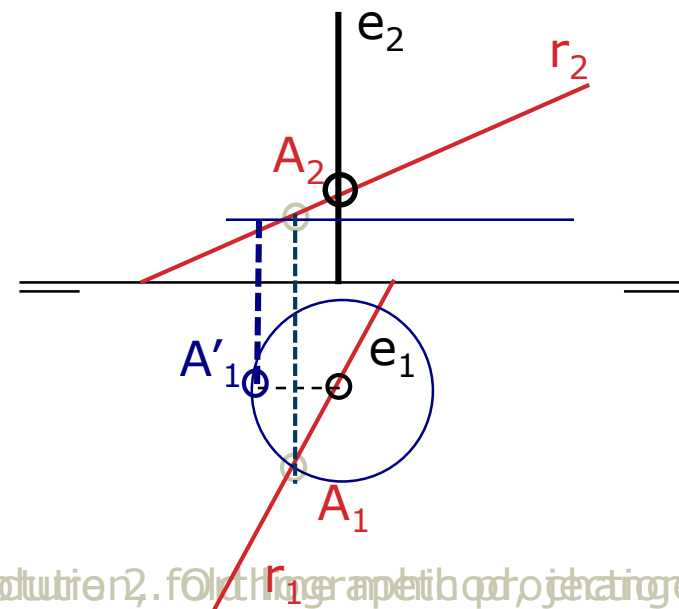
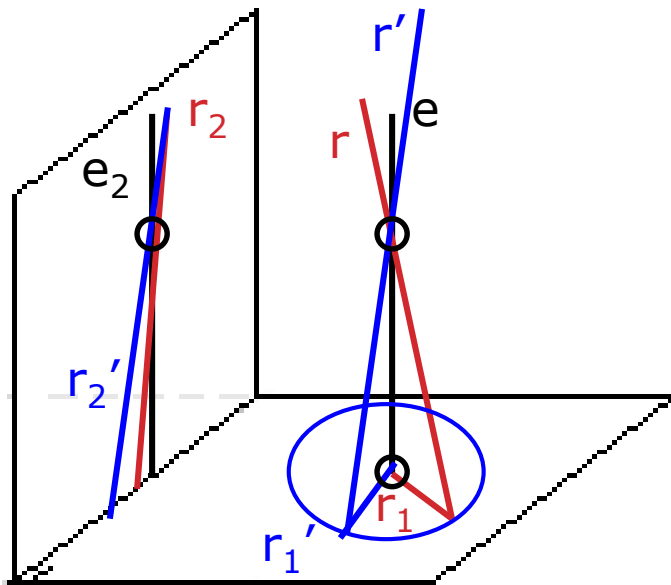

Revolution of a line II

- Transform a line r in a frontal line r' .
 - The axis e intersects with line r and is perpendicular to the horizontal plane H .
 - The intersection point (M) between line r and the axis e doesn't rotate.
 - Rotate a point A of the line r until $r'_1 // RL$, such that, you get $A'(A'_1, A'_2)$ and join A'_2 with M_2 to get r'_2 .

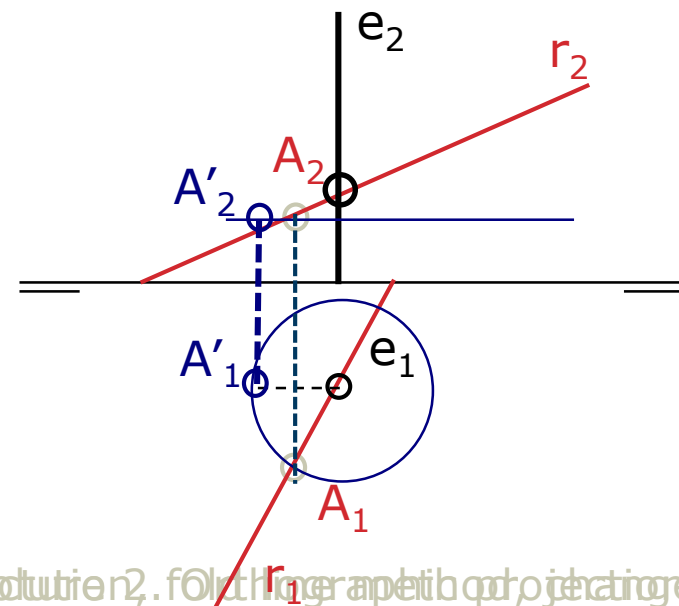
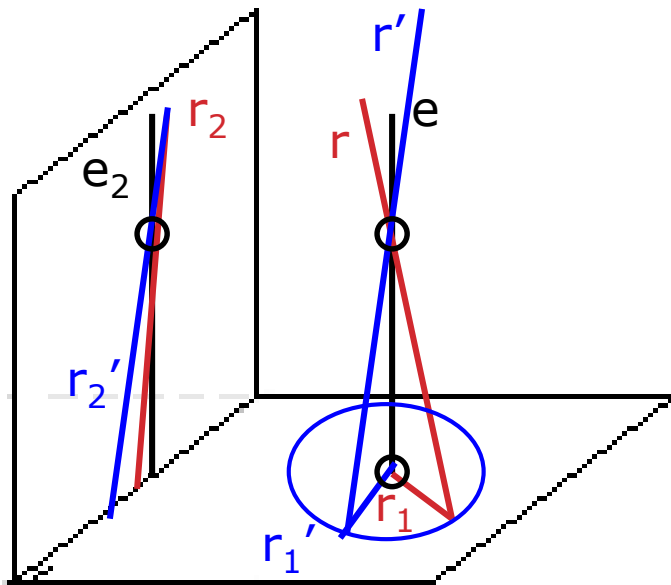

Revolution of a line II

- Transform a line r in a frontal line r' .
 - The axis e intersects with line r and is perpendicular to the horizontal plane H .
 - The intersection point (M) between line r and the axis e doesn't rotate.
 - Rotate a point A of the line r until $r'_1 // RL$, such that, you get $A'(A'_1, A'_2)$ and join A'_2 with M_2 to get r'_2 .

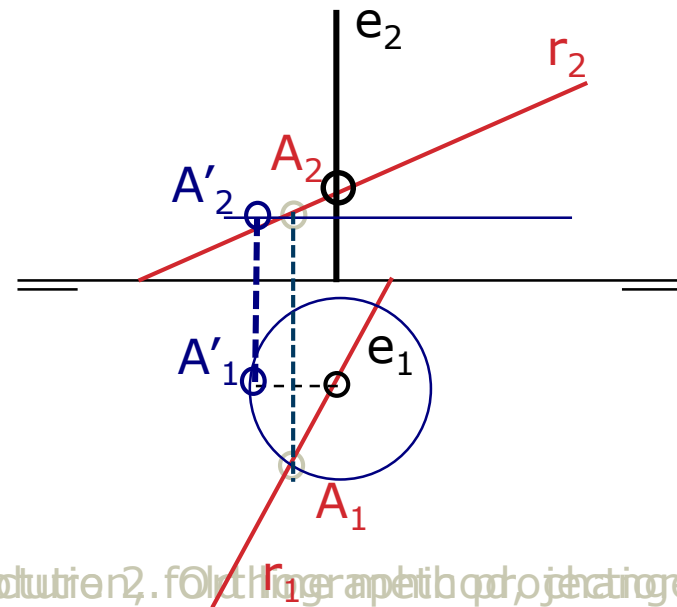
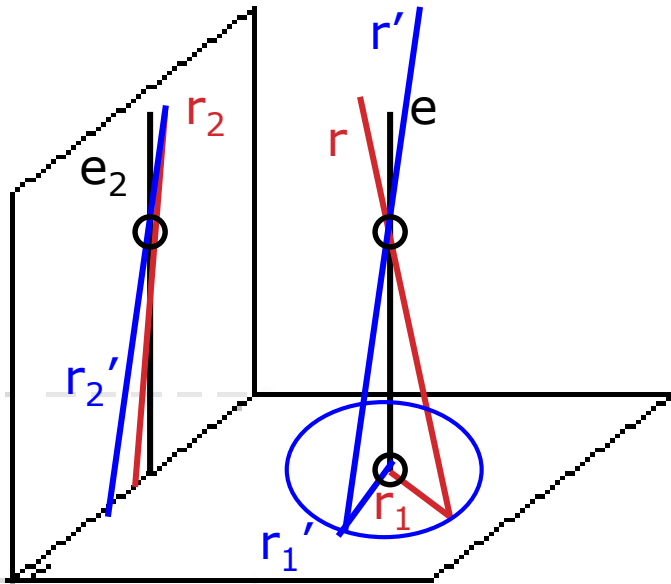

Revolution of a line II

- Transform a line r in a frontal line r' .
 - The axis e intersects with line r and is perpendicular to the horizontal plane H .
 - The intersection point (M) between line r and the axis e doesn't rotate.
 - Rotate a point A of the line r until $r'_1 // RL$, such that, you get $A'(A'_1, A'_2)$ and join A'_2 with M_2 to get r'_2 .

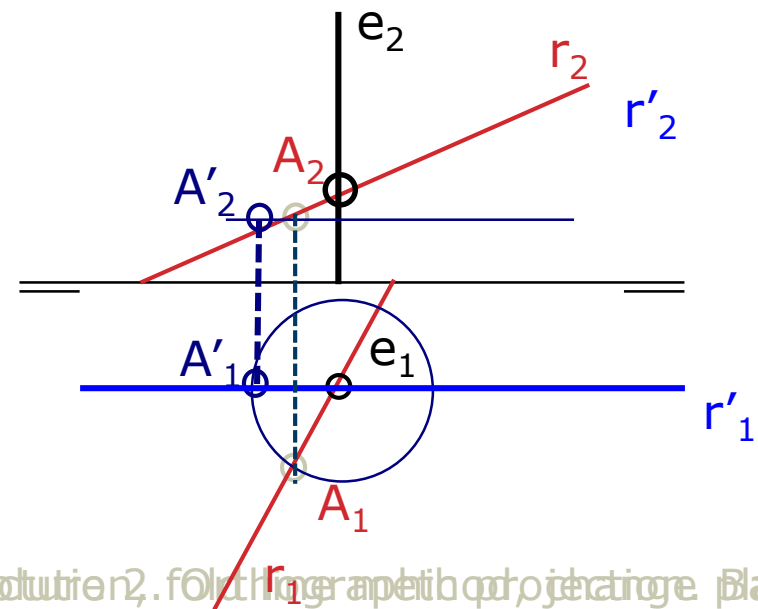
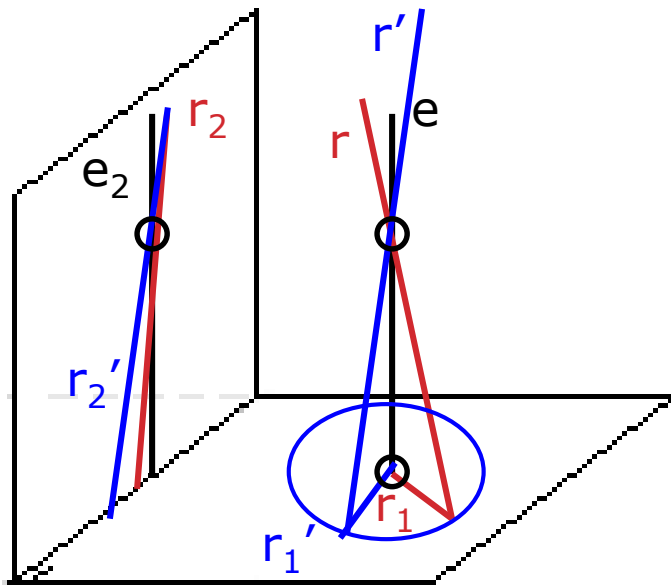

Revolution of a line II

- Transform a line r in a frontal line r' .
 - The axis e intersects with line r and is perpendicular to the horizontal plane H .
 - The intersection point (M) between line r and the axis e doesn't rotate.
 - Rotate a point A of the line r until $r'_1 // RL$, such that, you get $A'(A'_1, A'_2)$ and join A'_2 with M_2 to get r'_2 .

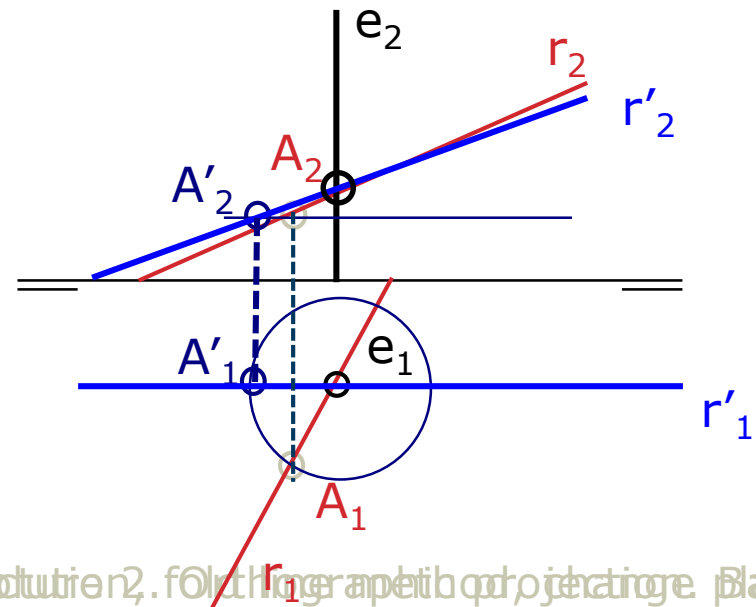
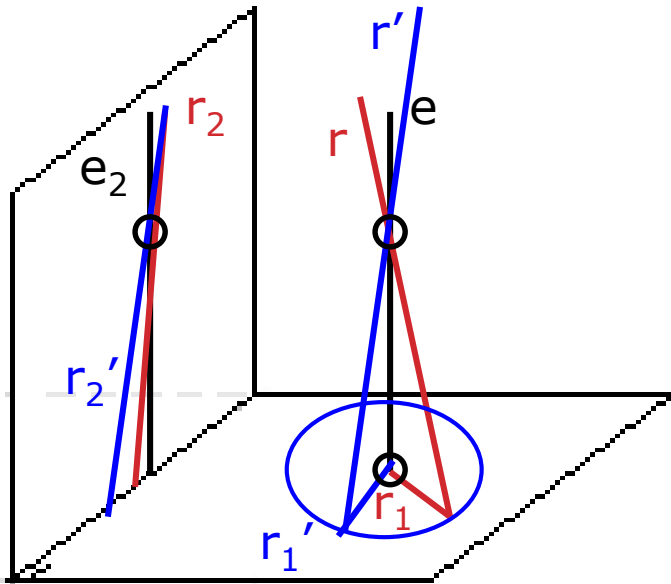

Revolution of a line III

- Transform a frontal line r in a vertical line r' .
 - The axis e intersects with line r and is perpendicular to the vertical plane V .
 - The point of intersection M between line r and the axis e *doesn't rotate*.
 - Rotate a point A of the line r , until $r'_2 \perp RL$, such that, you get $A'(A'_1, A'_2)$ and r'_1 coincides with A'_1 .

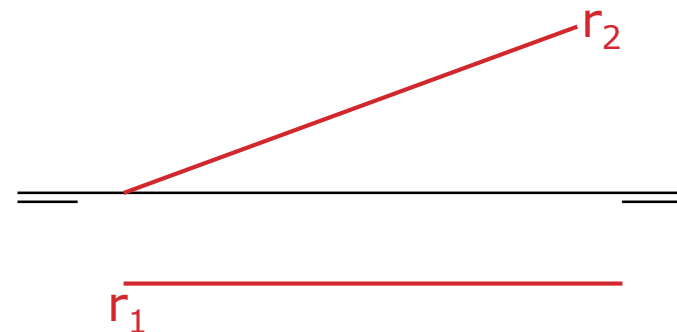
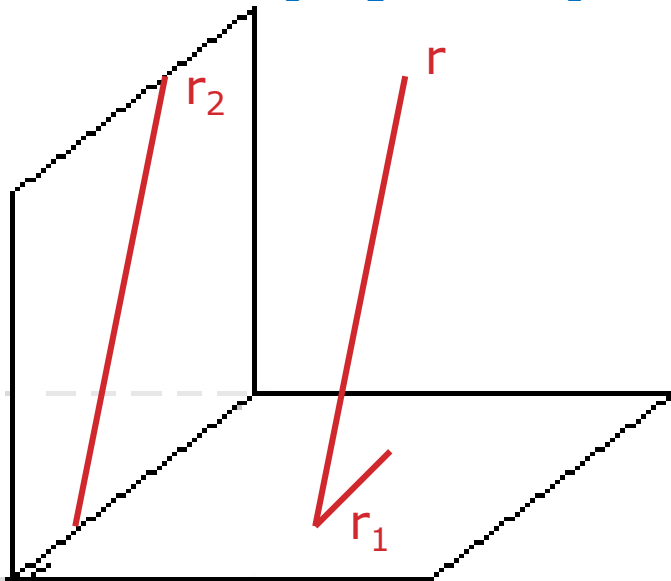

Revolution of a line III

- Transform a frontal line r in a vertical line r' .
 - The axis e intersects with line r and is perpendicular to the vertical plane V .
 - The point of intersection M between line r and the axis e *doesn't rotate*.
 - Rotate a point A of the line r , until $r'_2 \perp RL$, such that, you get $A'(A'_1, A'_2)$ and r'_1 coincides with A'_1 .

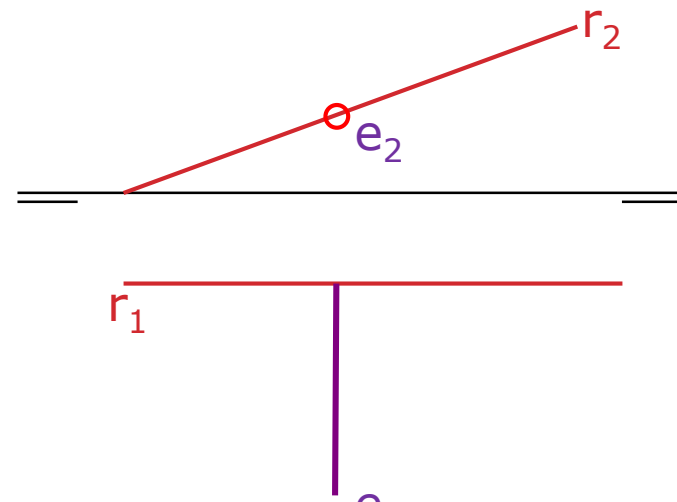
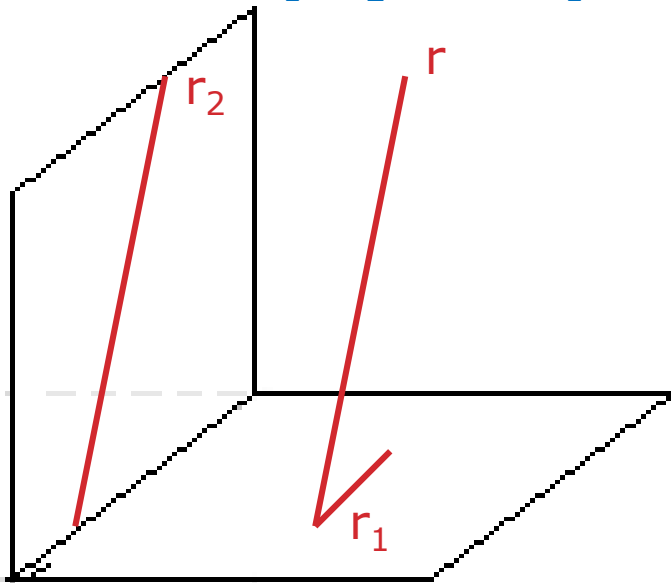

Revolution of a line III

- Transform a frontal line r in a vertical line r' .
 - The axis e intersects with line r and is perpendicular to the vertical plane V .
 - The point of intersection M between line r and the axis e *doesn't rotate*.
 - Rotate a point A of the line r , until $r'_2 \perp RL$, such that, you get $A'(A'_1, A'_2)$ and r'_1 coincides with A'_1 .

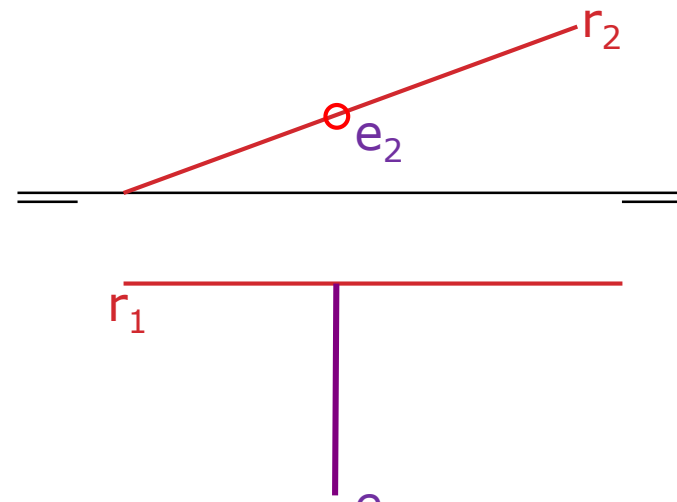
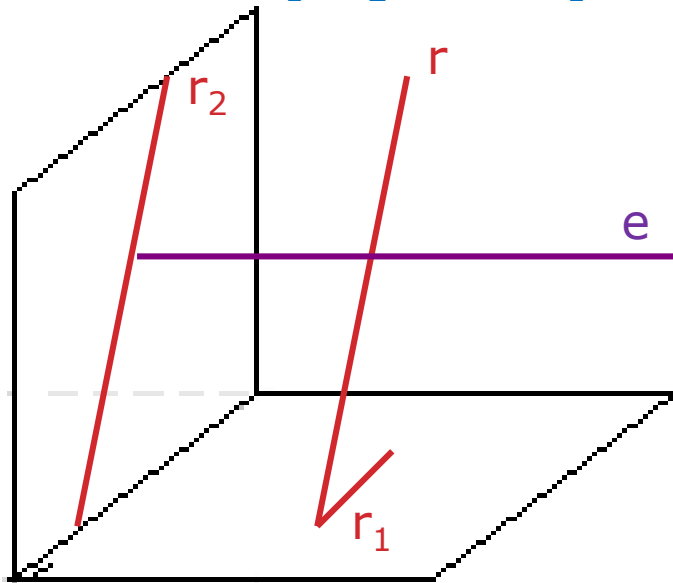

Revolution of a line III

- Transform a frontal line r in a vertical line r' .
 - The axis e intersects with line r and is perpendicular to the vertical plane V .
 - The point of intersection M between line r and the axis e *doesn't rotate*.
 - Rotate a point A of the line r , until $r'_2 \perp RL$, such that, you get $A'(A'_1, A'_2)$ and r'_1 coincides with A'_1 .

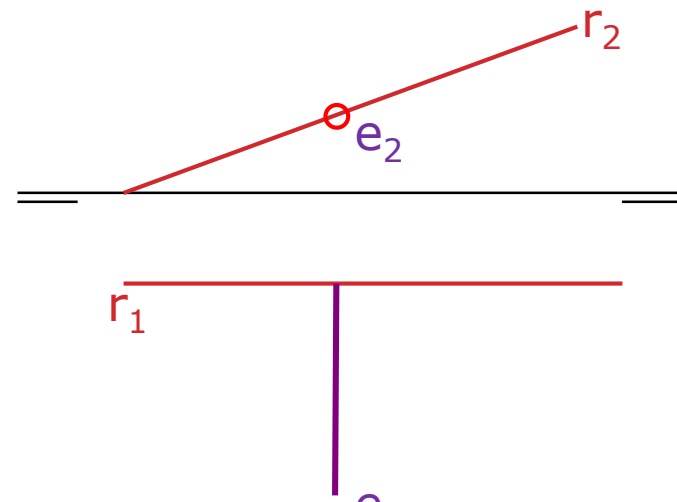
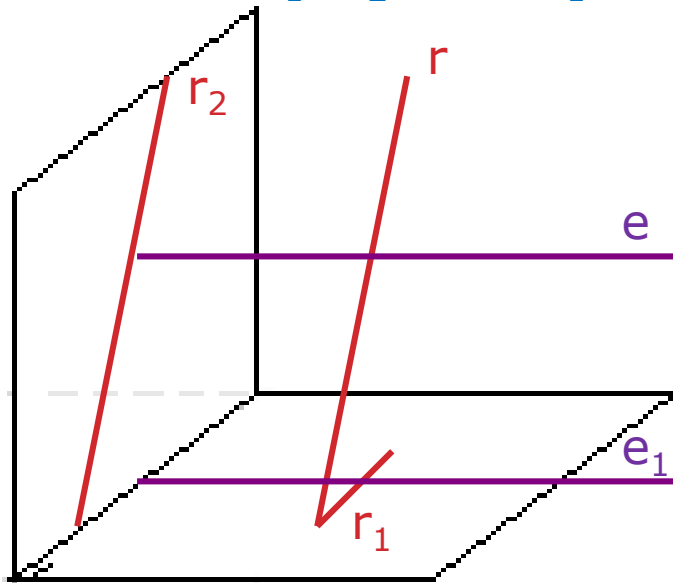

Revolution of a line III

- Transform a frontal line r in a vertical line r' .
 - The axis e intersects with line r and is perpendicular to the vertical plane V .
 - The point of intersection M between line r and the axis e *doesn't rotate*.
 - Rotate a point A of the line r , until $r'_2 \perp RL$, such that, you get $A'(A'_1, A'_2)$ and r'_1 coincides with A'_1 .

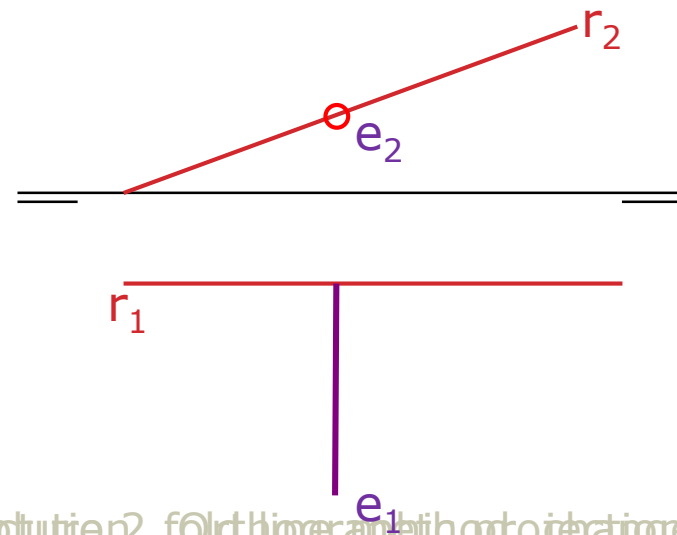
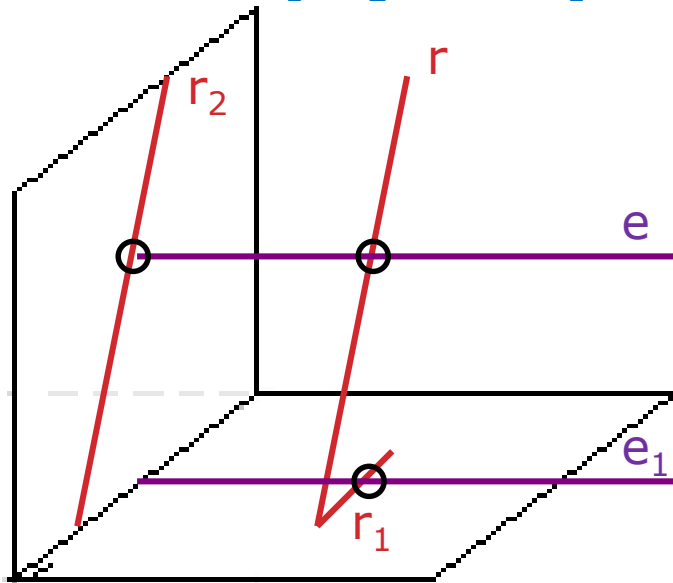

Revolution of a line III

- Transform a frontal line r in a vertical line r' .
 - The axis e intersects with line r and is perpendicular to the vertical plane V .
 - The point of intersection M between line r and the axis e *doesn't rotate*.
 - Rotate a point A of the line r , until $r'_2 \perp RL$, such that, you get $A'(A'_1, A'_2)$ and r'_1 coincides with A'_1 .

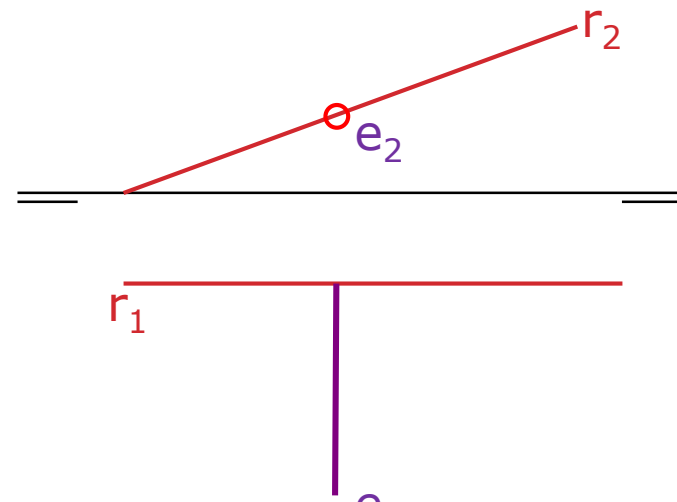
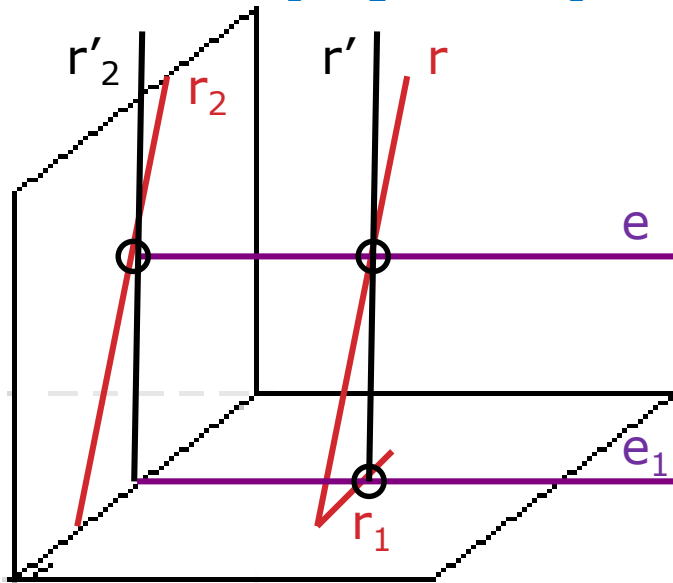

Revolution of a line III

- Transform a frontal line r in a vertical line r' .
 - The axis e intersects with line r and is perpendicular to the vertical plane V .
 - The point of intersection M between line r and the axis e *doesn't rotate*.
 - Rotate a point A of the line r , until $r'_2 \perp RL$, such that, you get $A'(A'_1, A'_2)$ and r'_1 coincides with A'_1 .

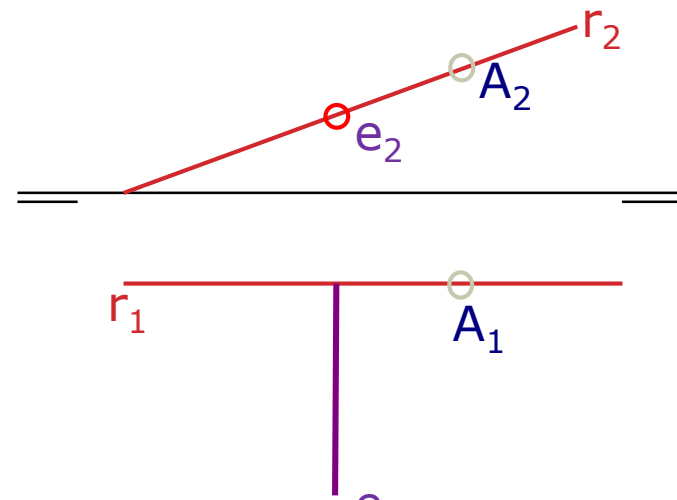
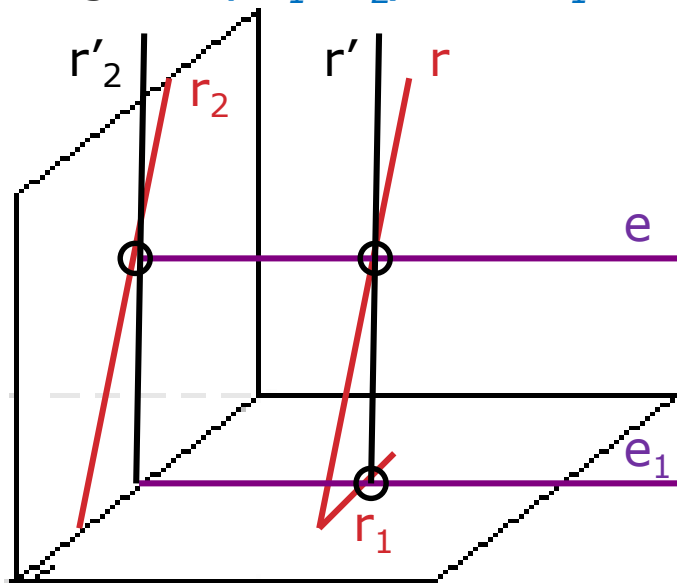

Revolution of a line III

- Transform a frontal line r in a vertical line r' .
 - The axis e intersects with line r and is perpendicular to the vertical plane V .
 - The point of intersection M between line r and the axis e *doesn't rotate*.
 - Rotate a point A of the line r , until $r'_2 \perp RL$, such that, you get $A'(A'_1, A'_2)$ and r'_1 coincides with A'_1 .

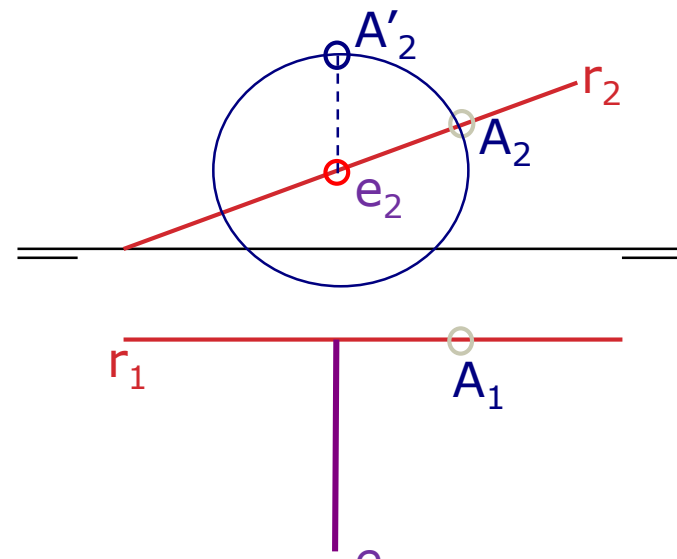
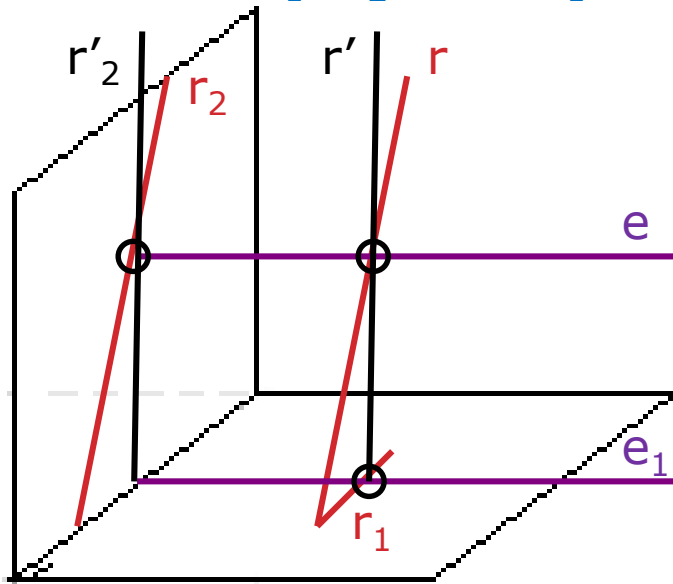

Revolution of a line III

- Transform a frontal line r in a vertical line r' .
 - The axis e intersects with line r and is perpendicular to the vertical plane V .
 - The point of intersection M between line r and the axis e *doesn't rotate*.
 - Rotate a point A of the line r , until $r'_2 \perp RL$, such that, you get $A'(A'_1, A'_2)$ and r'_1 coincides with A'_1 .

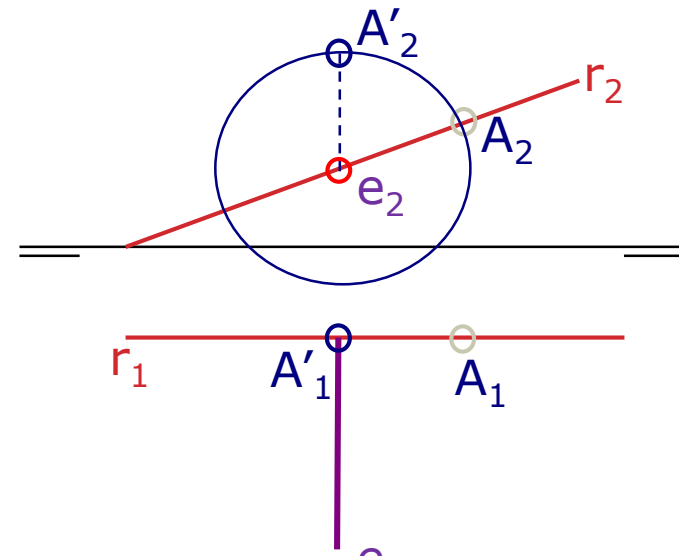
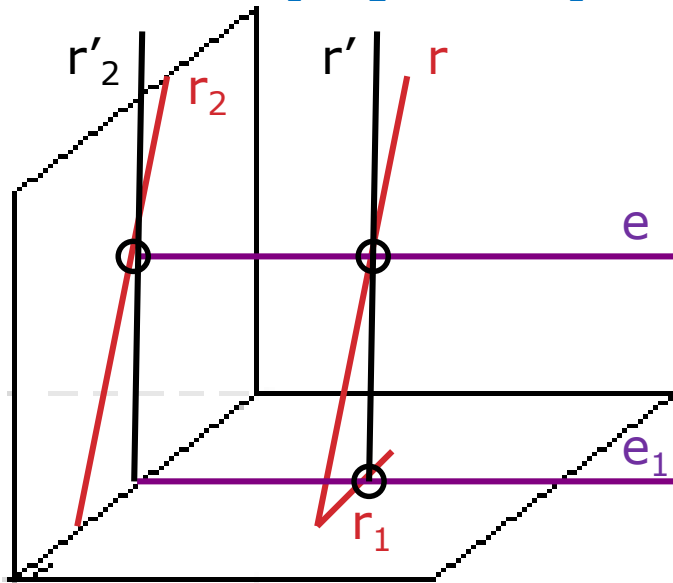

Revolution of a line III

- Transform a frontal line r in a vertical line r' .
 - The axis e intersects with line r and is perpendicular to the vertical plane V .
 - The point of intersection M between line r and the axis e *doesn't rotate*.
 - Rotate a point A of the line r , until $r'_2 \perp RL$, such that, you get $A'(A'_1, A'_2)$ and r'_1 coincides with A'_1 .

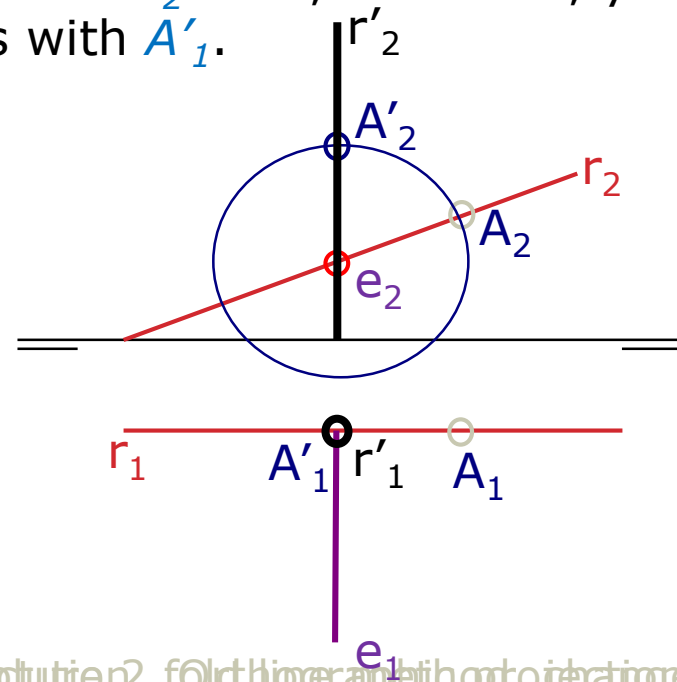
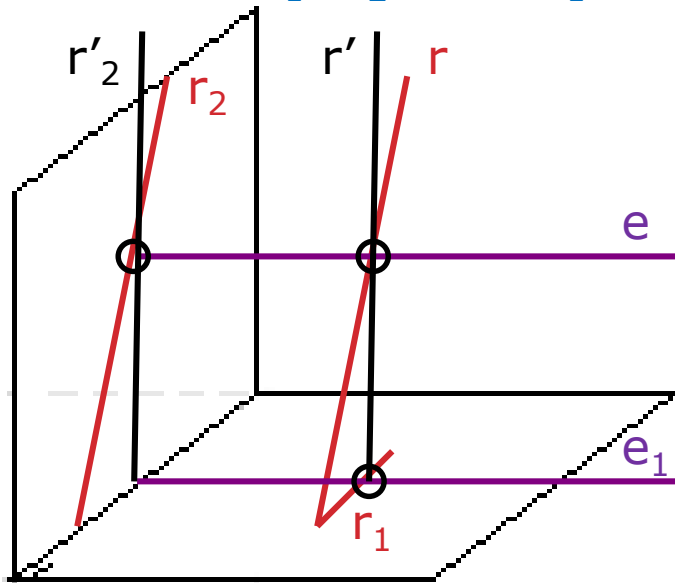

Revolution of a line IV

- Conclusion 1: A line can be transformed in a vertical line, by means of 2 rotations:
 - 1. A rotation \perp to plane H \Rightarrow frontal line.
 - 2. A rotation \perp to plane V \Rightarrow vertical line.

- Conclusion 2: A line can be transformed in a tip line, by means of 2 rotations:
 - 1. A rotation \perp to plane V \Rightarrow horizontal line.
 - 2. A rotation \perp to plane H \Rightarrow tip line.

Examples

- Calculate the distance between 2 points

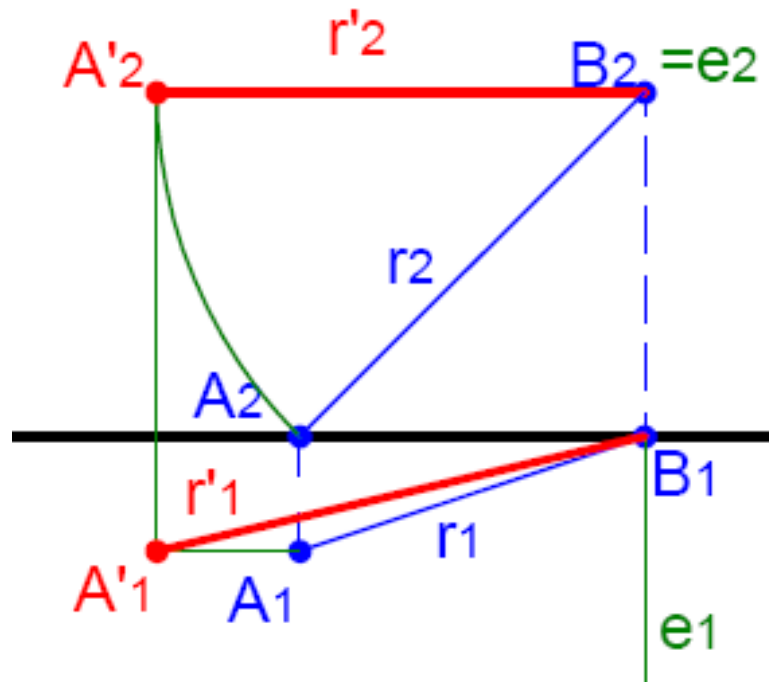

Examples

- Calculate the distance between 2 points

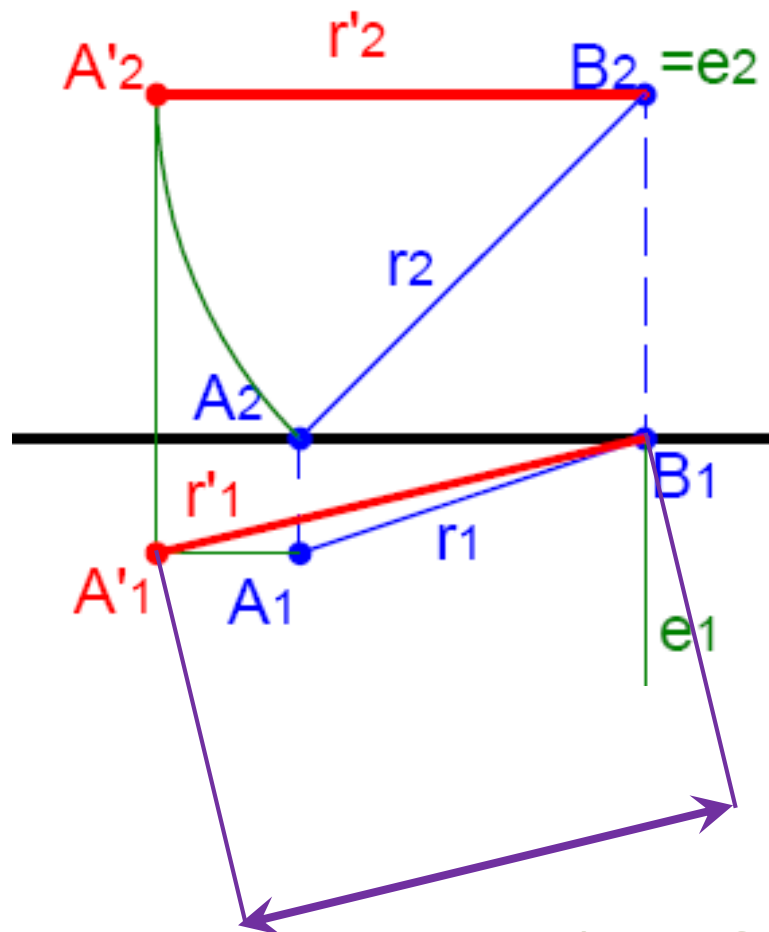

Examples

- Calculate the angle between a line and a the projection plane

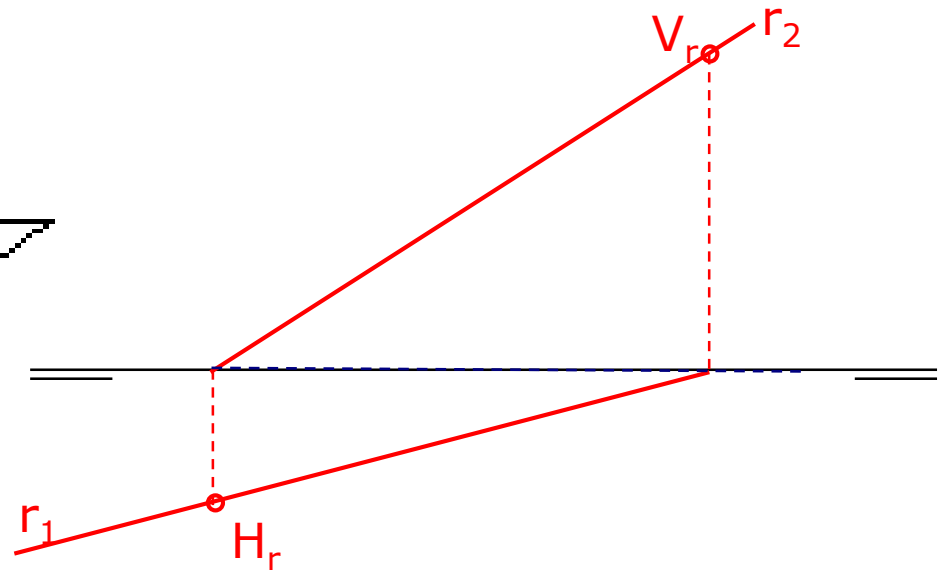
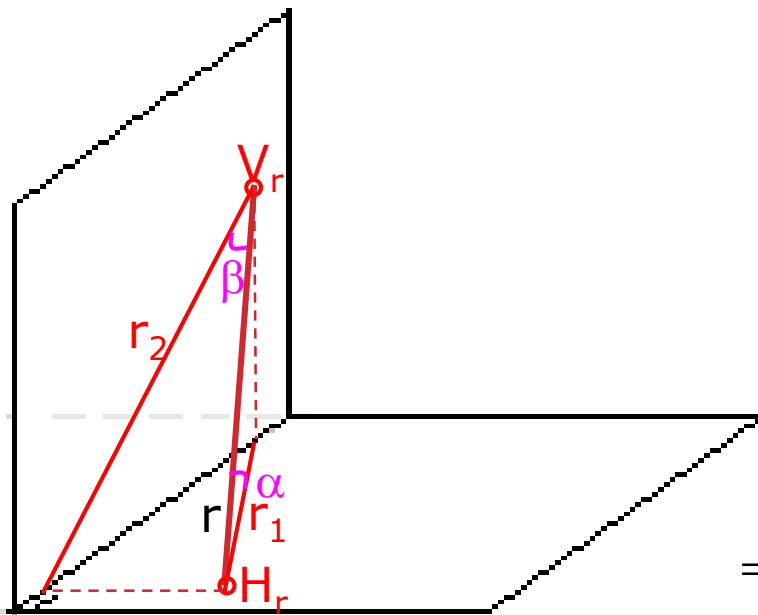

Examples

- Calculate the angle between a line and a the projection plane

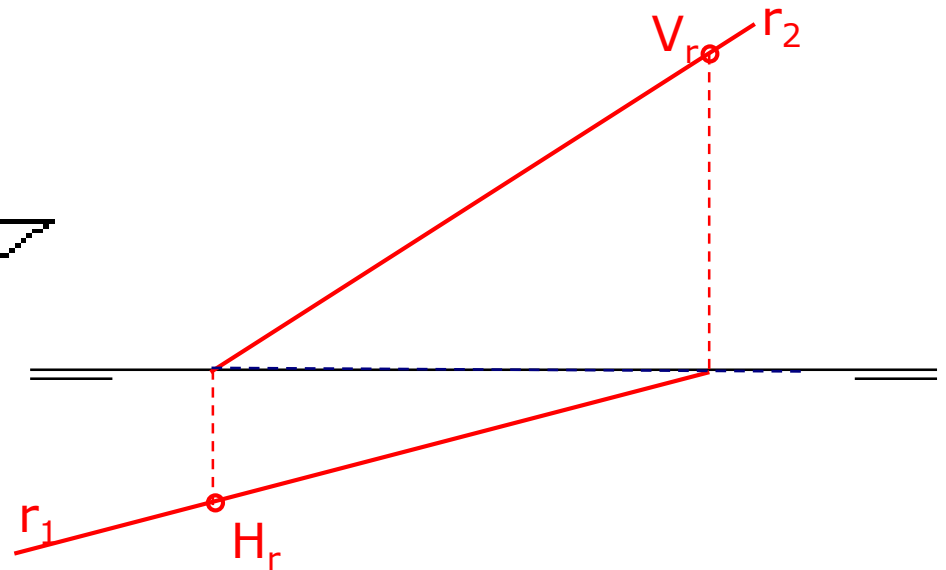
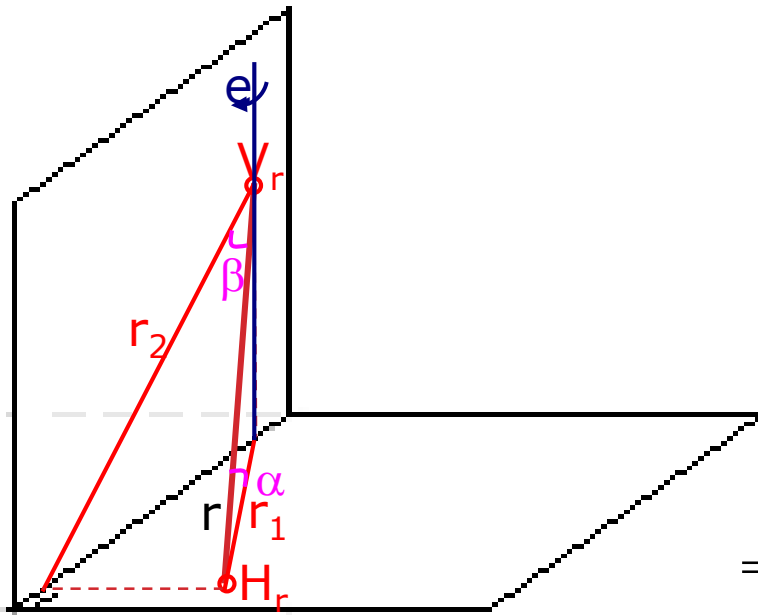

Examples

- Calculate the angle between a line and a the projection plane

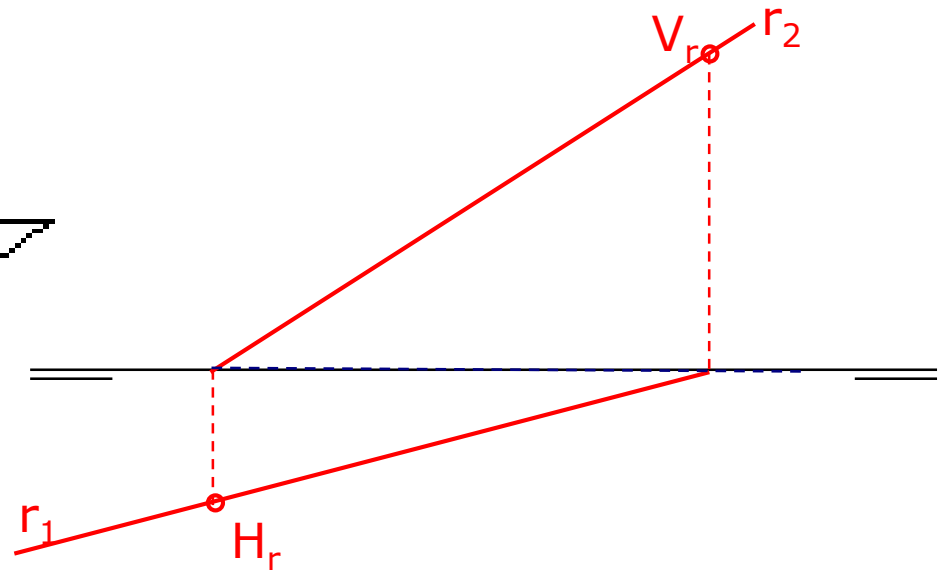
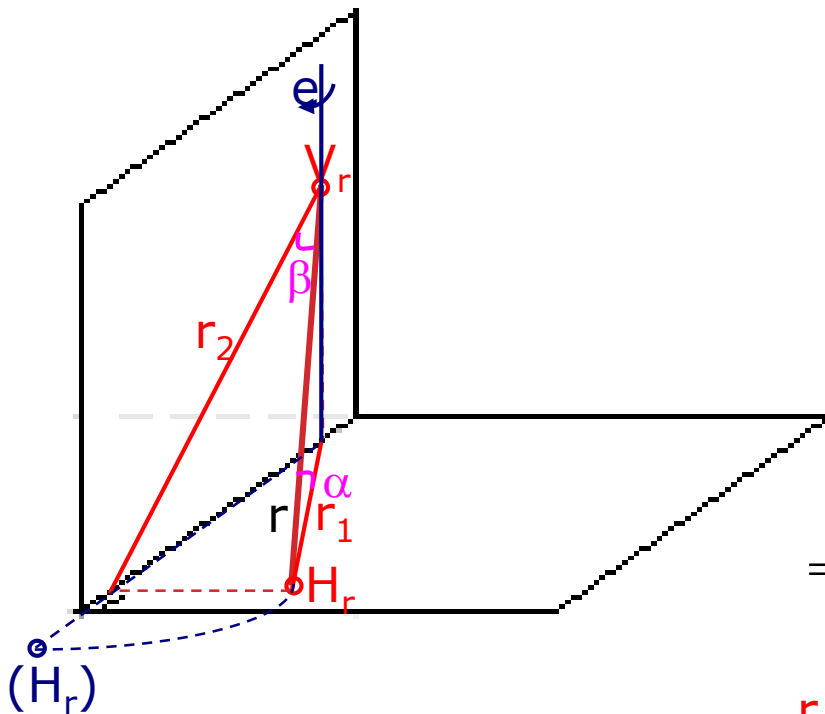

Examples

- Calculate the angle between a line and a the projection plane

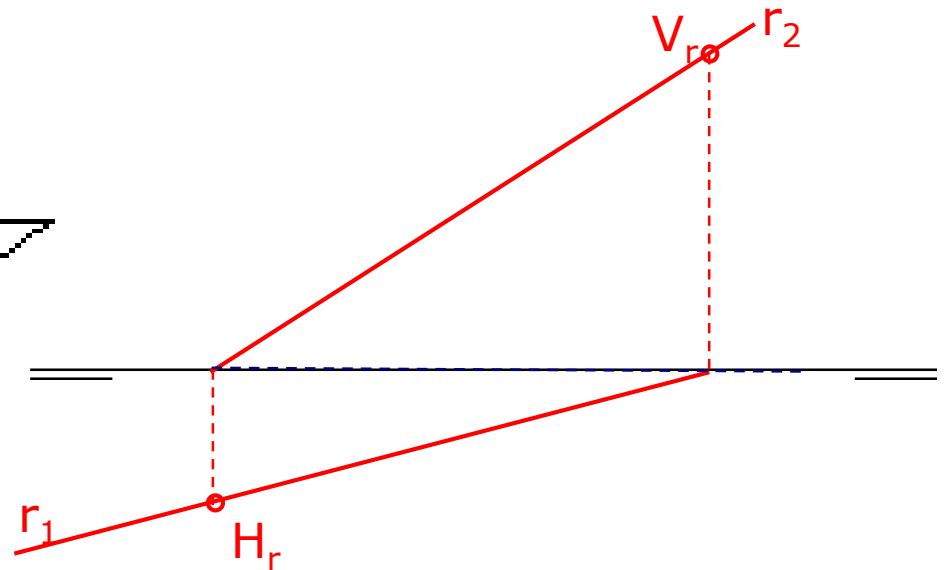
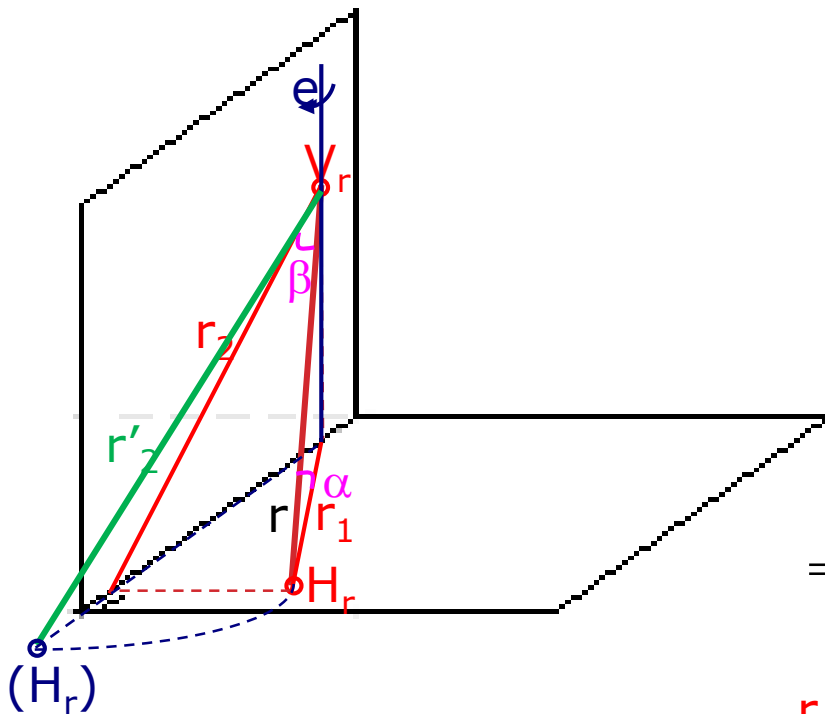

Examples

- Calculate the angle between a line and a the projection plane

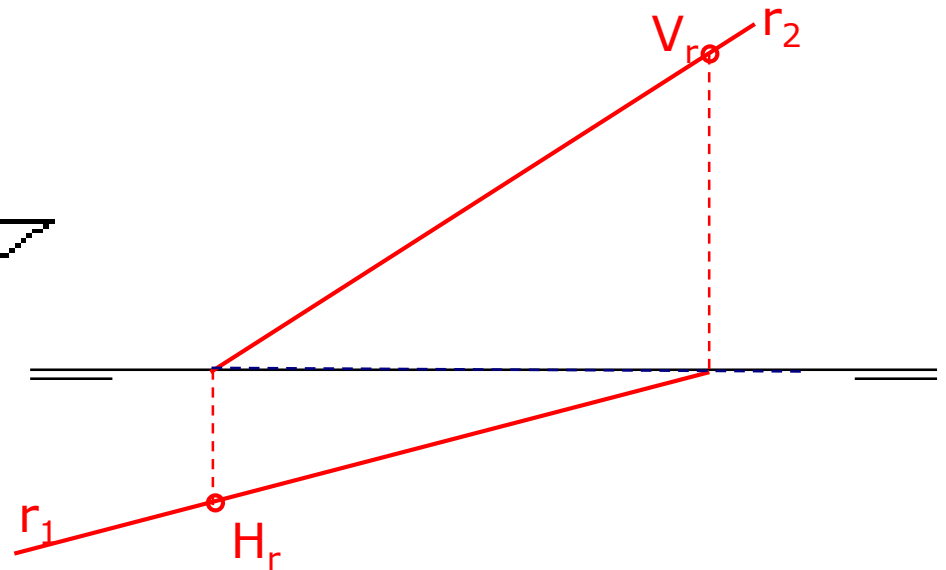
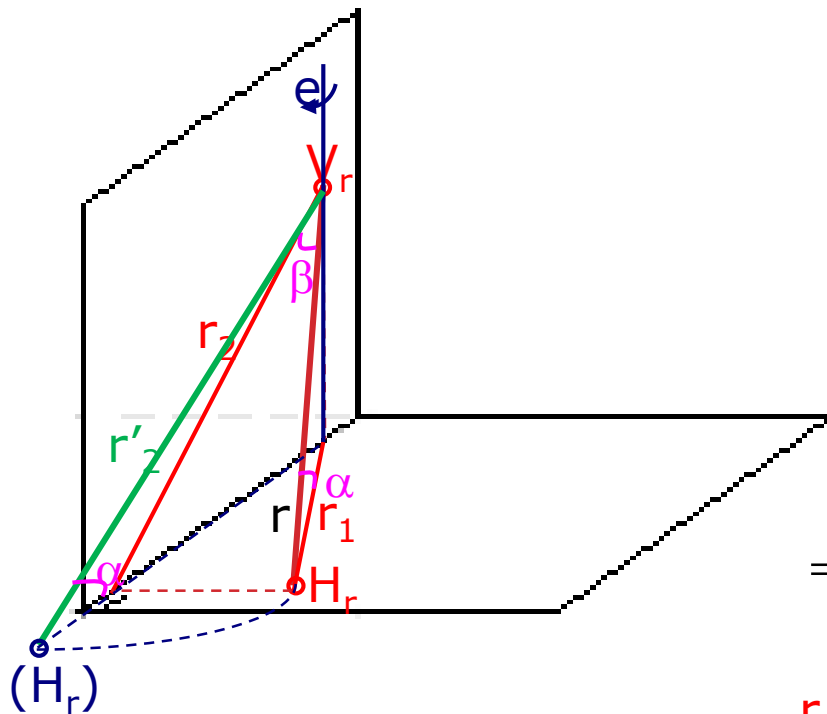

Examples

- Calculate the angle between a line and a the projection plane

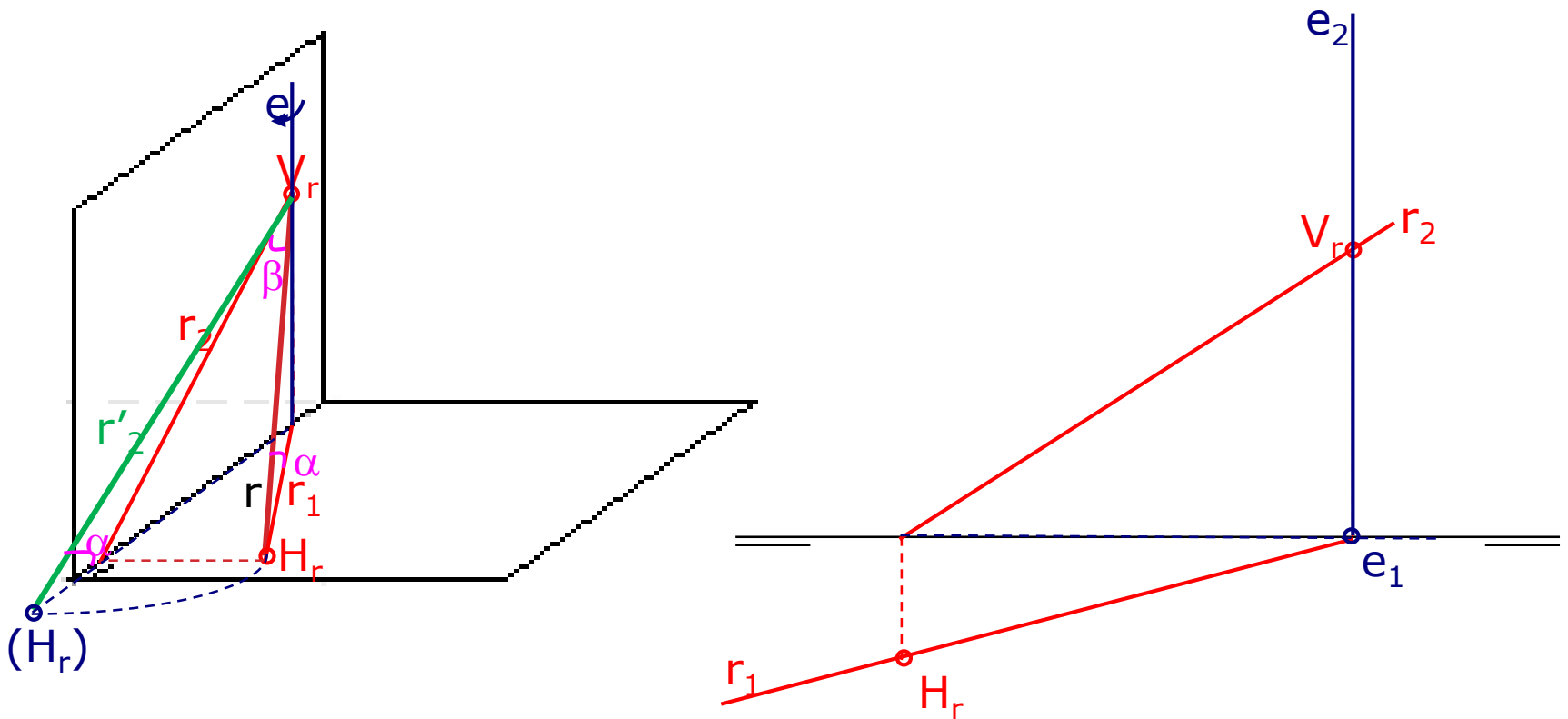

Examples

- Calculate the angle between a line and a the projection plane

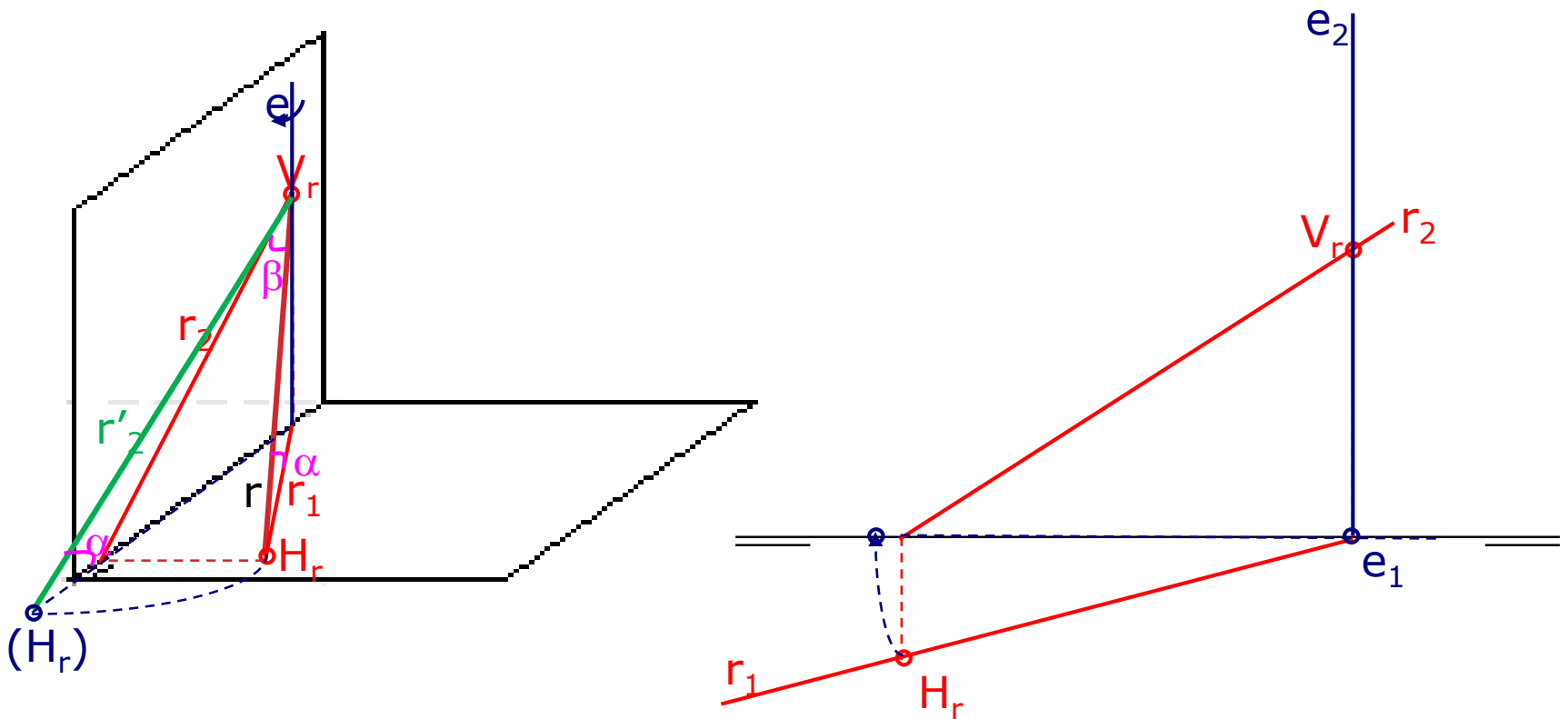

Examples

- Calculate the angle between a line and a the projection plane

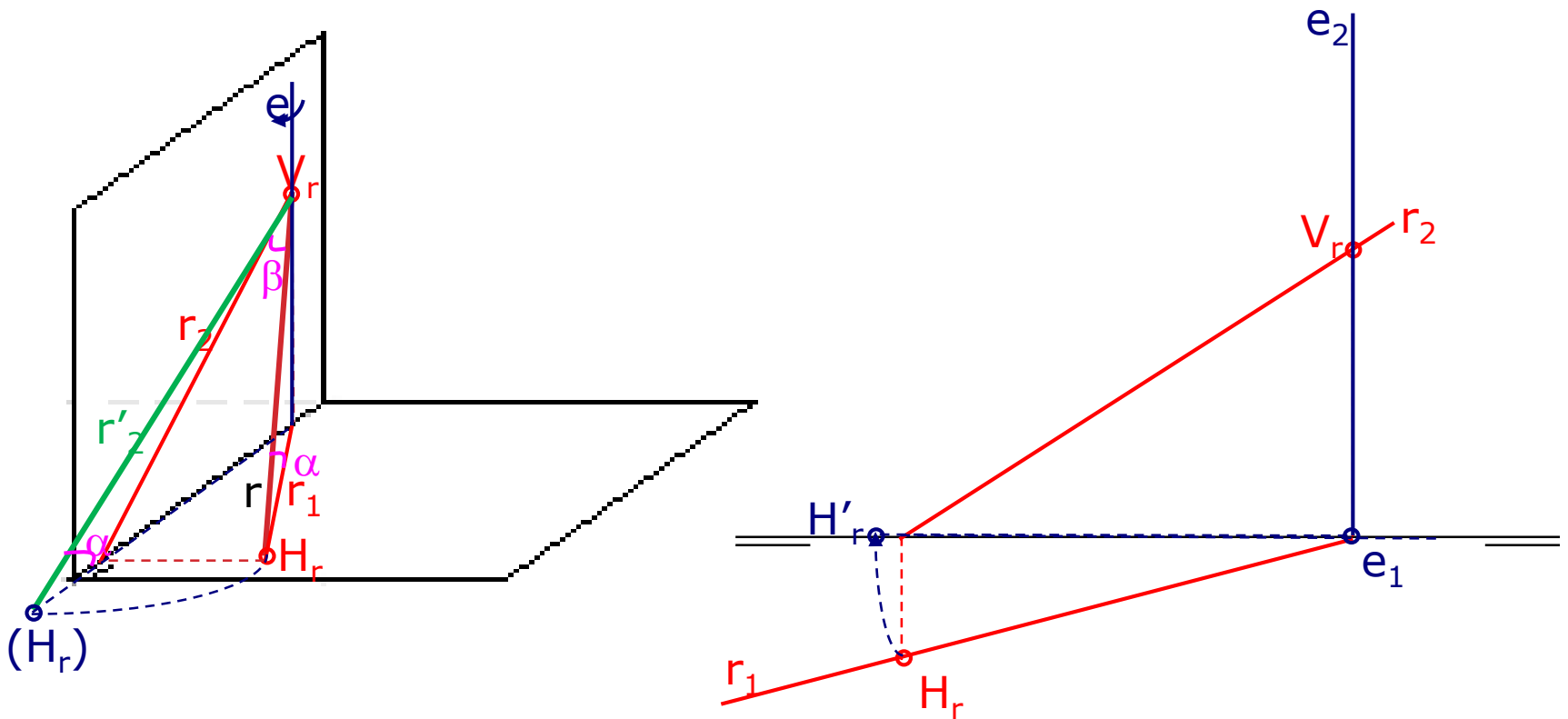

Examples

- Calculate the angle between a line and a the projection plane

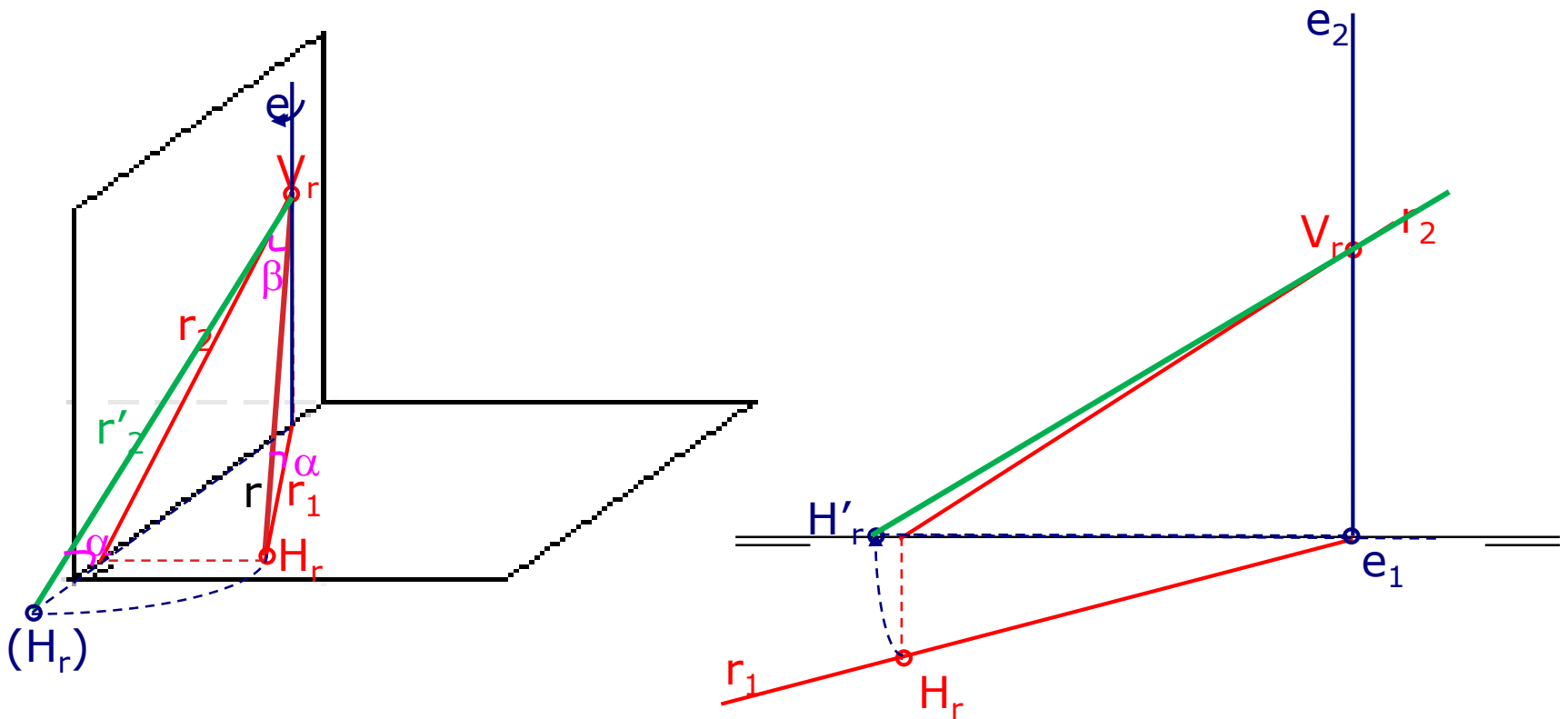

Examples

- Calculate the angle between a line and a the projection plane

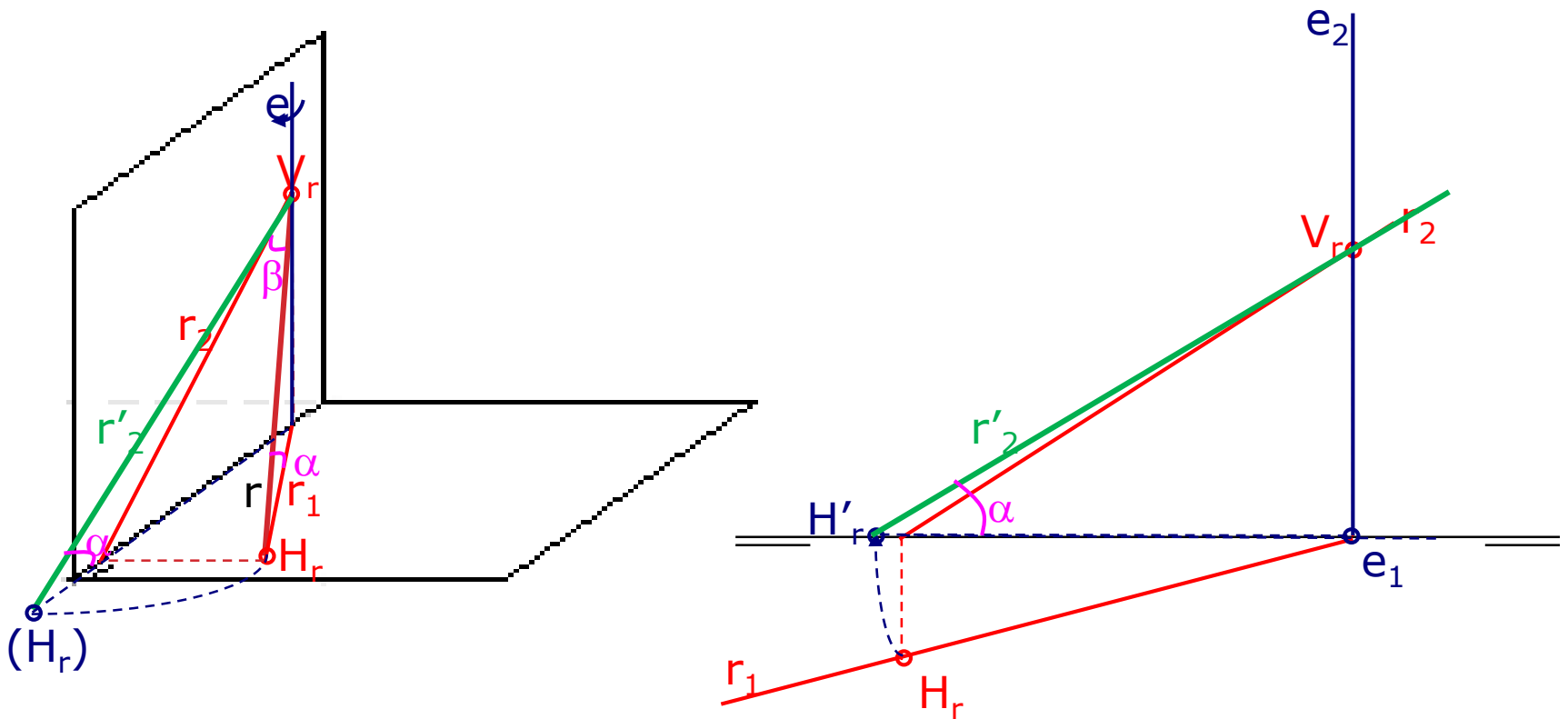

Examples

- Calculate the angle between a line and a the projection plane

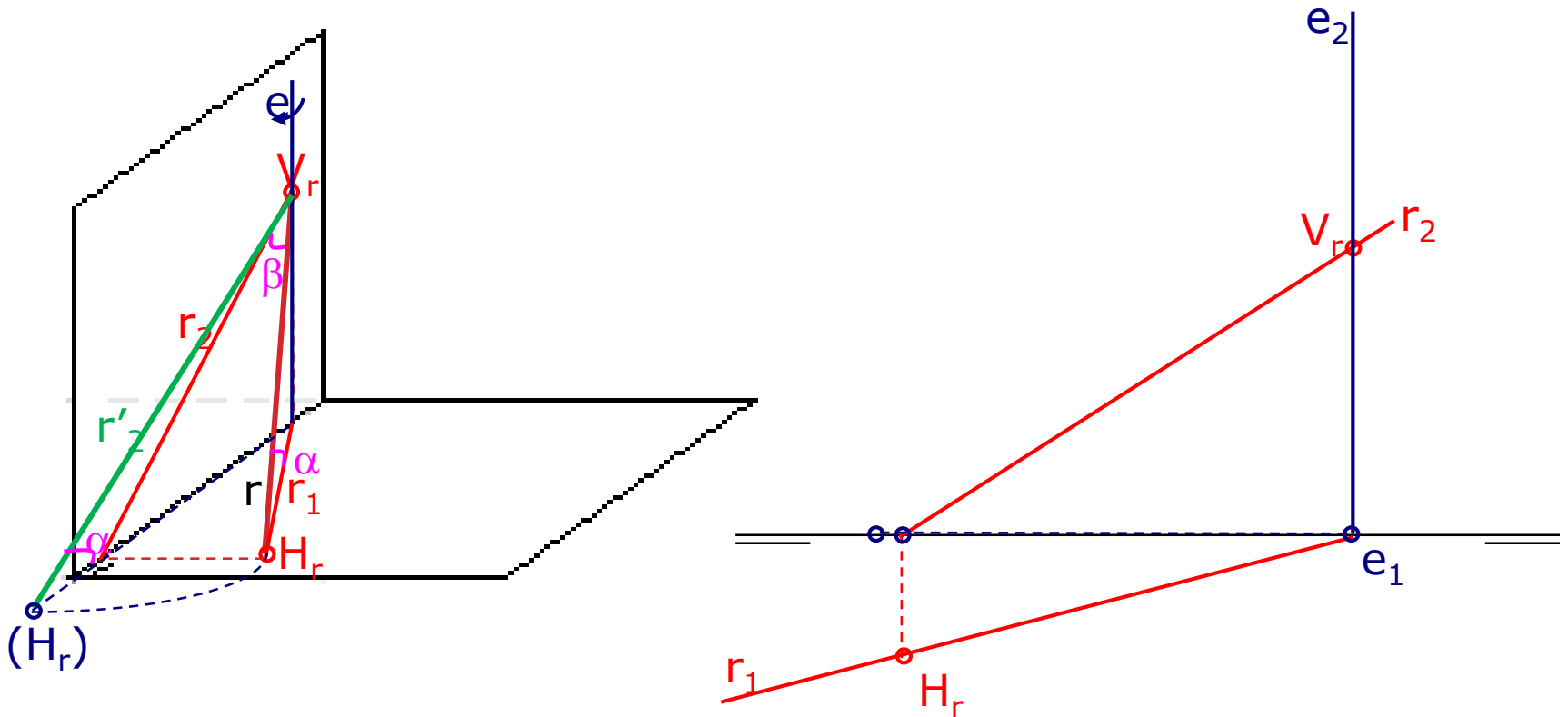

Examples

- Calculate the angle between a line and a the projection plane

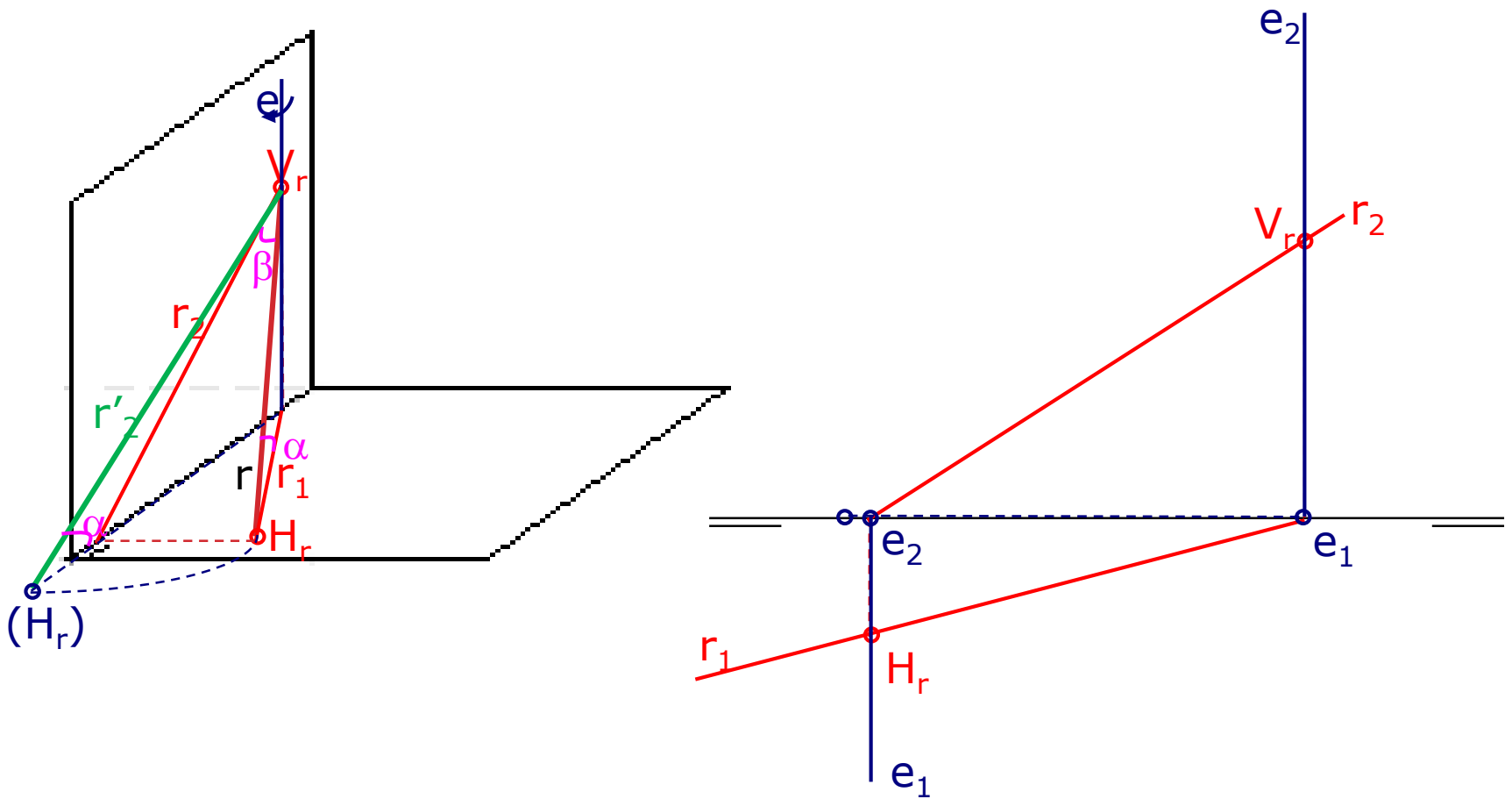

Examples

- Calculate the angle between a line and a the projection plane

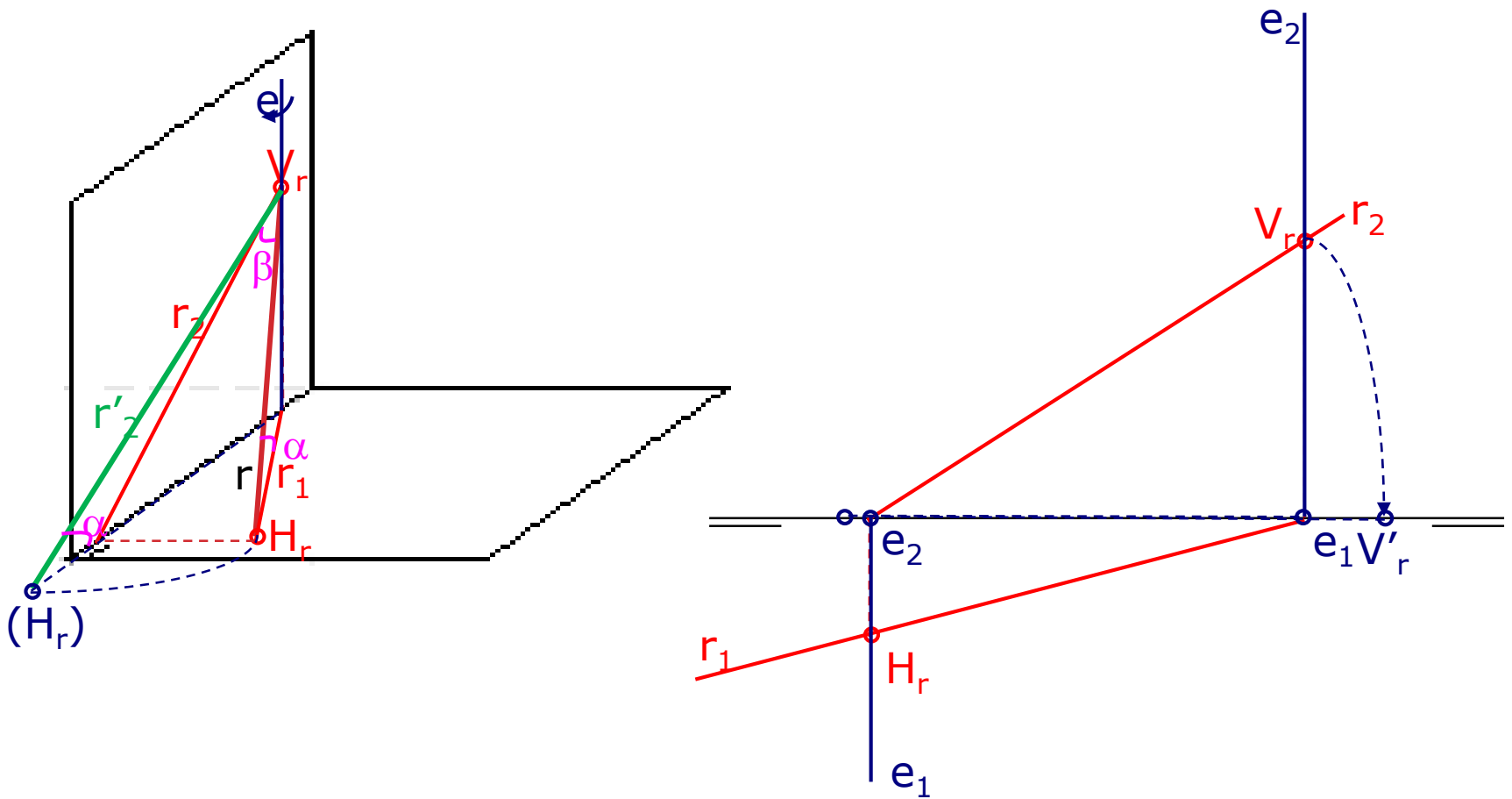

Examples

- Calculate the angle between a line and a the projection plane

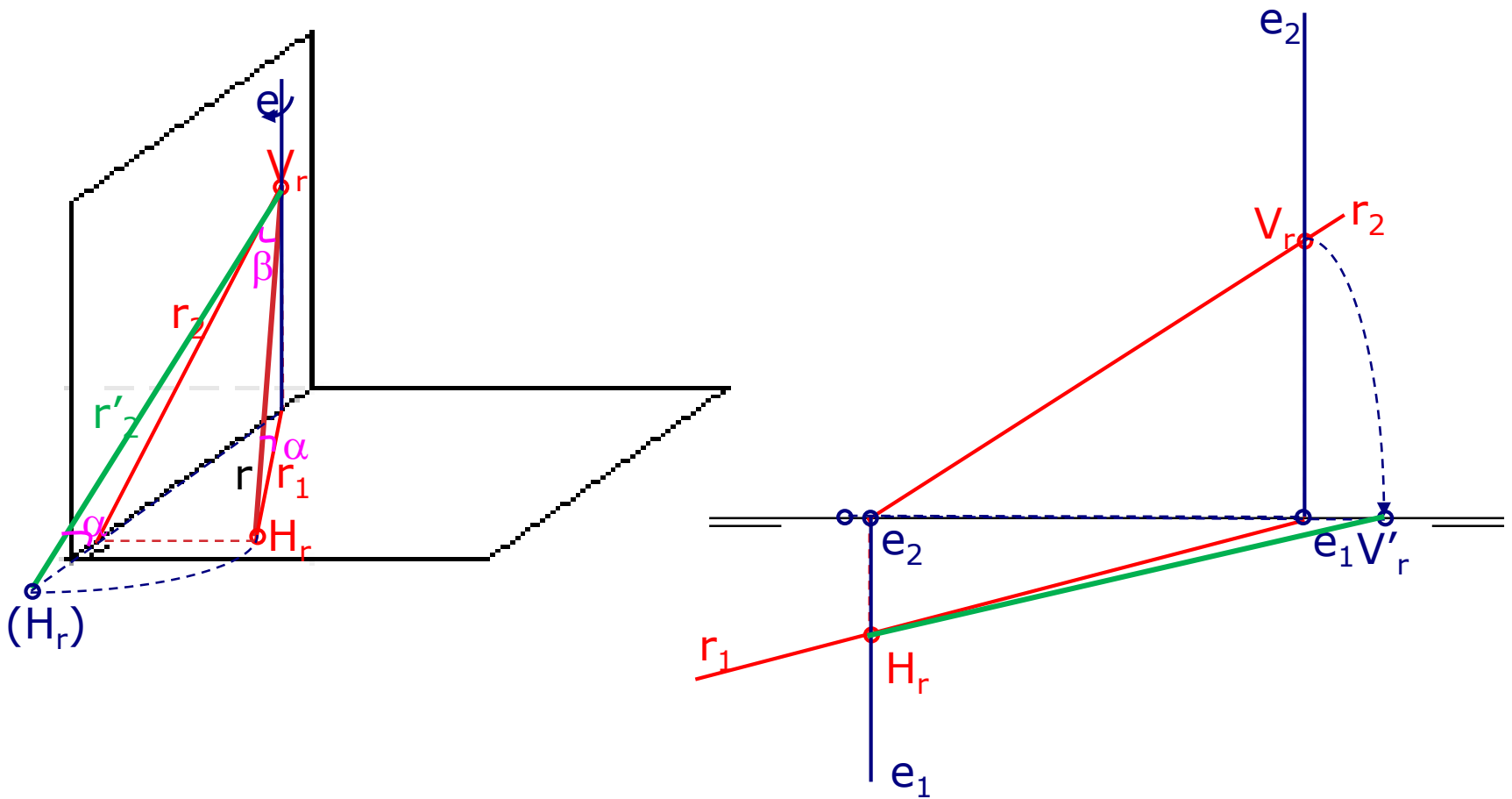

Examples

- Calculate the angle between a line and a the projection plane

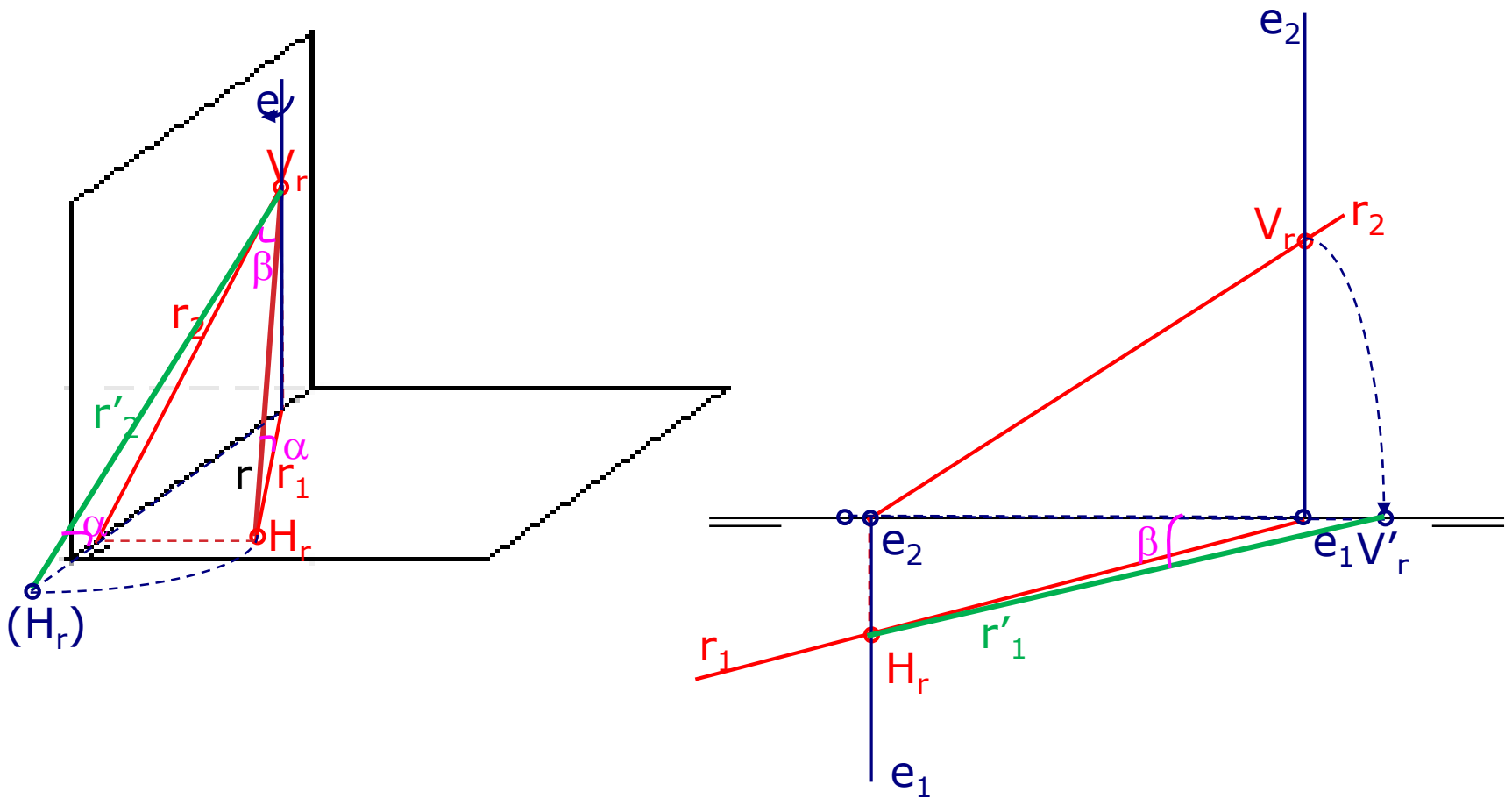

Revolution of a plane

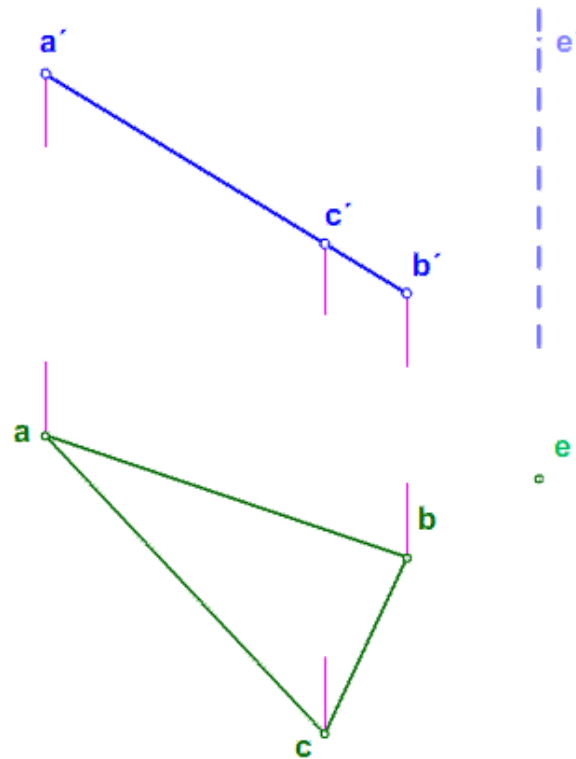

Revolution of a plane I

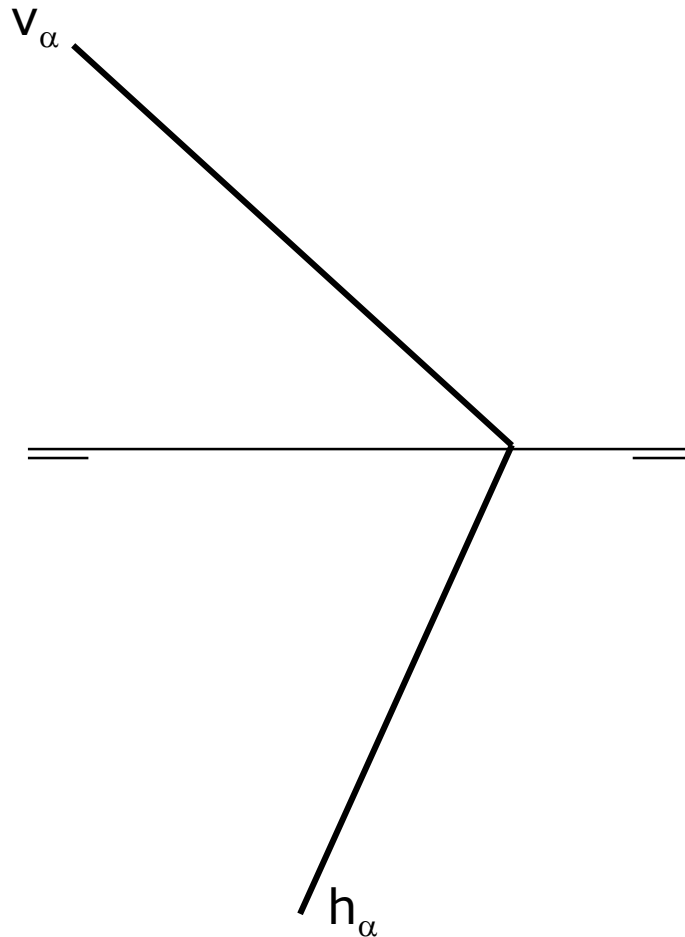

Revolution of a plane I

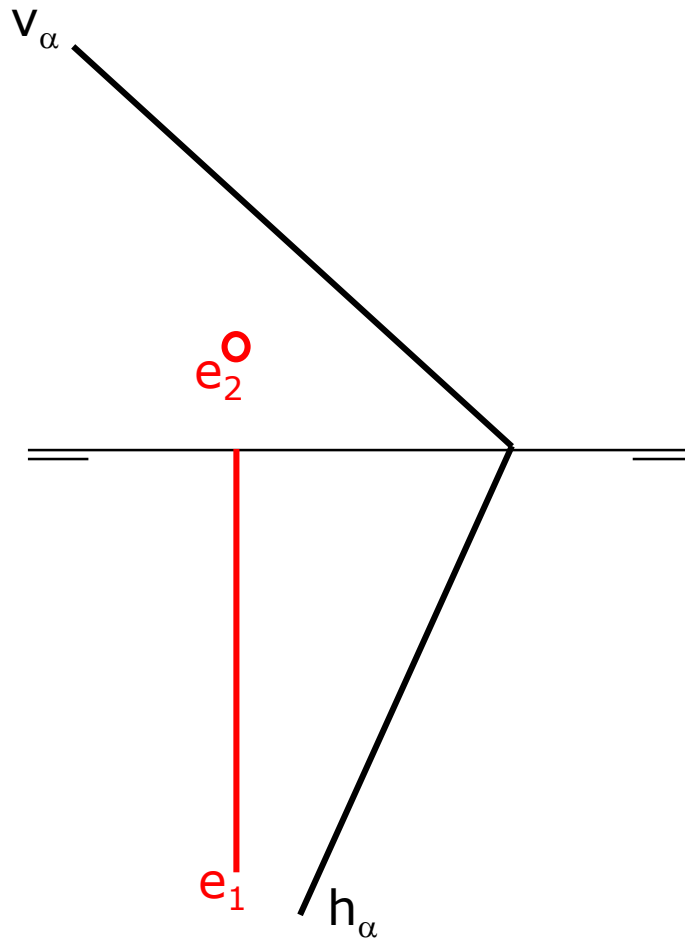

Revolution of a plane I

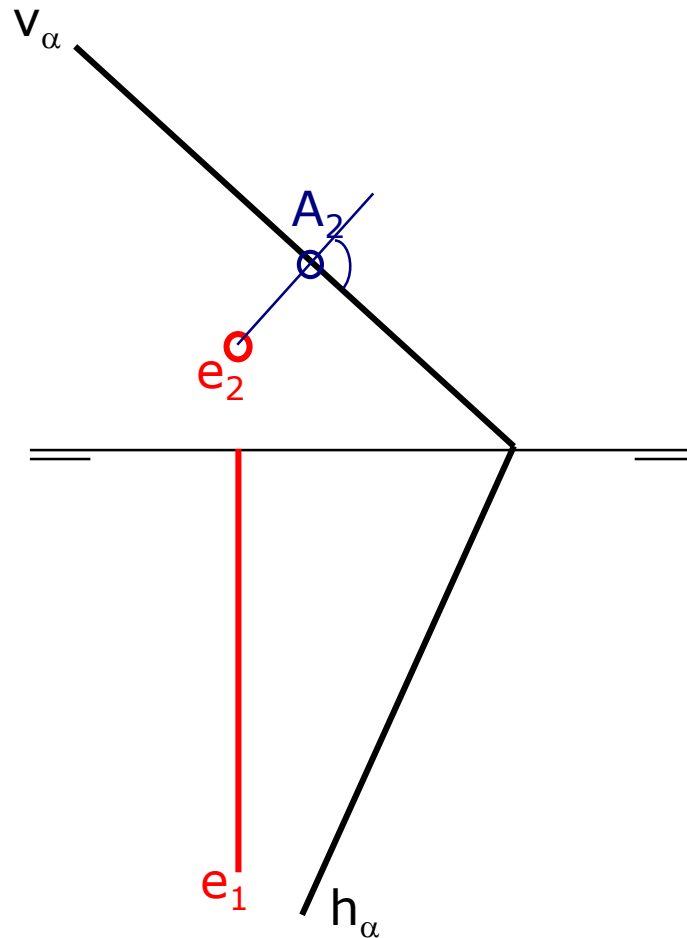

Revolution of a plane I

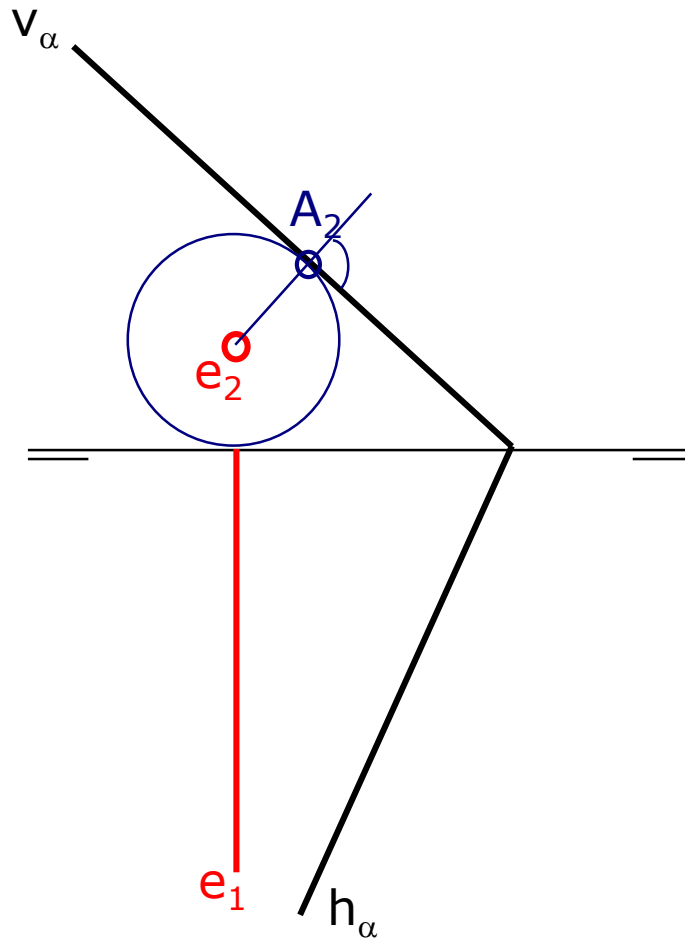

Revolution of a plane I

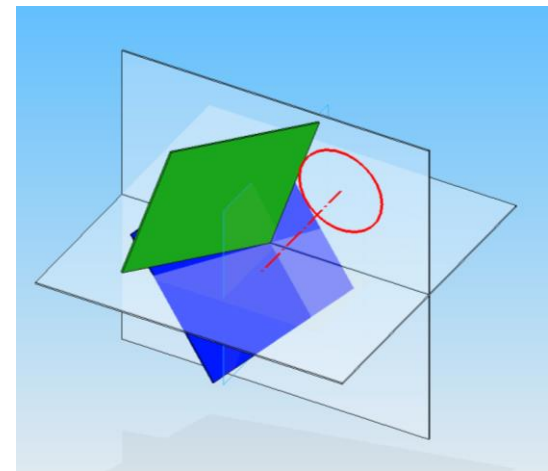
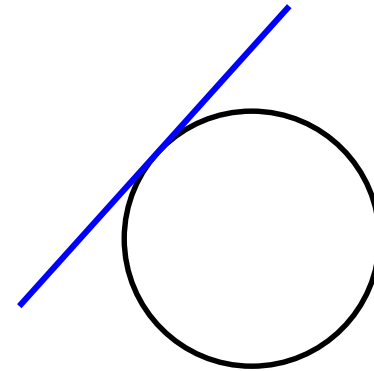
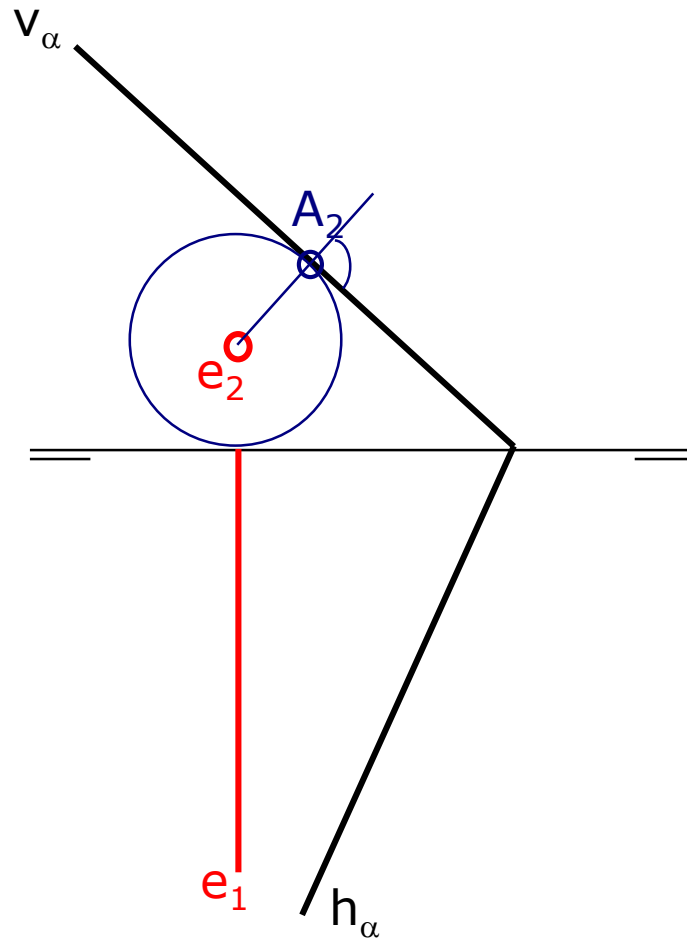

Revolution of a plane I

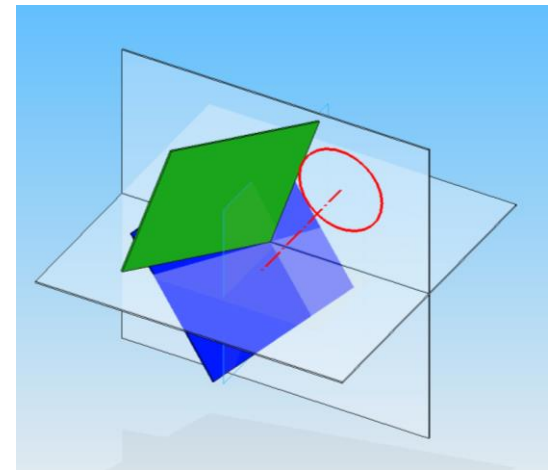
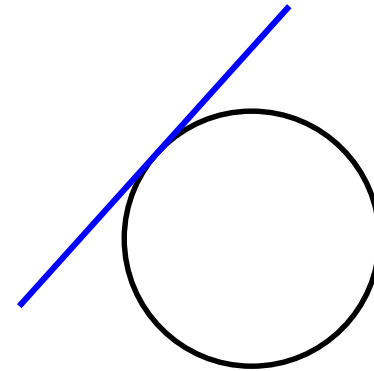
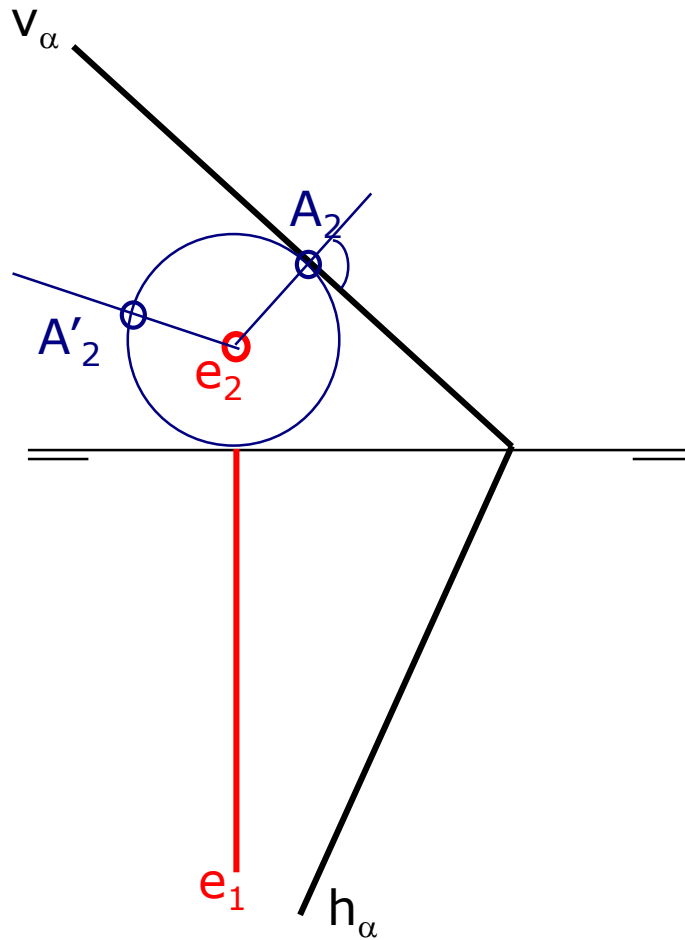

Revolution of a plane I

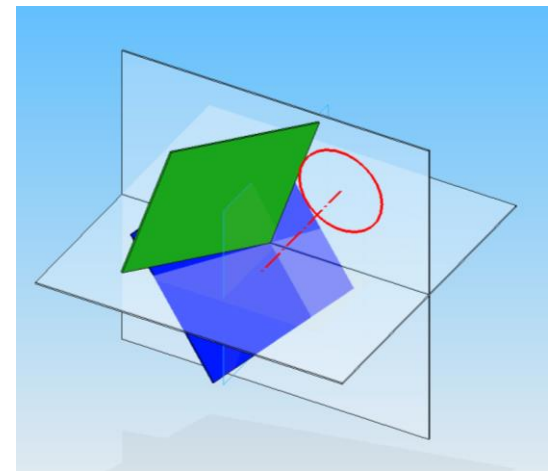
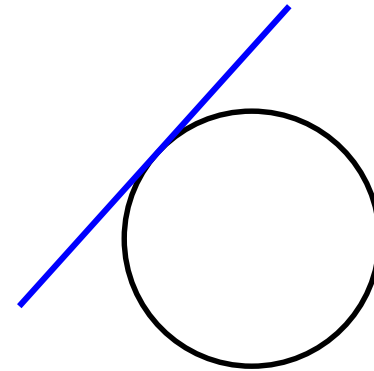
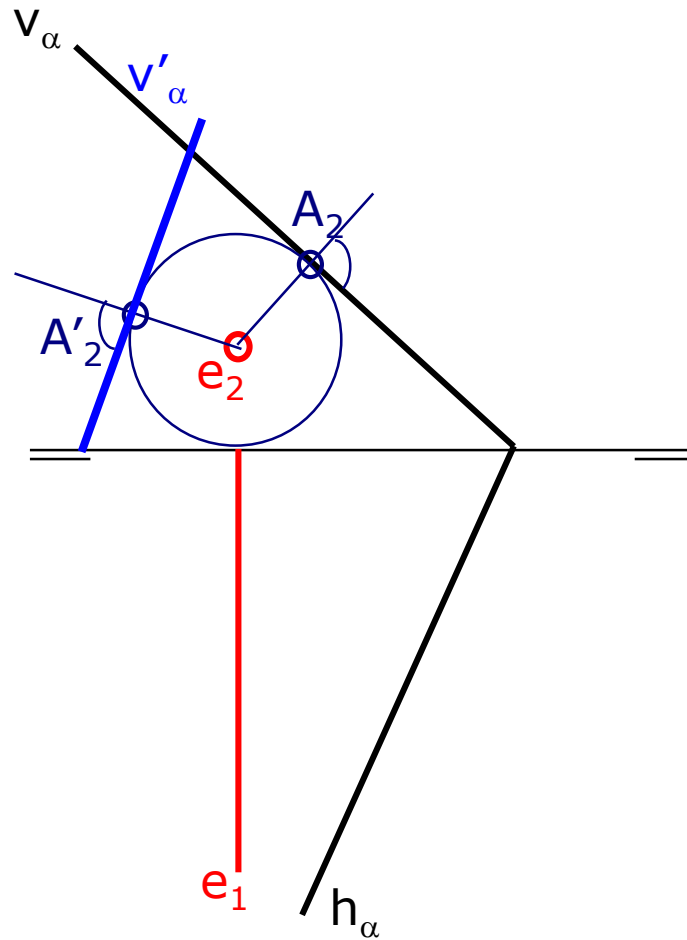

Revolution of a plane I

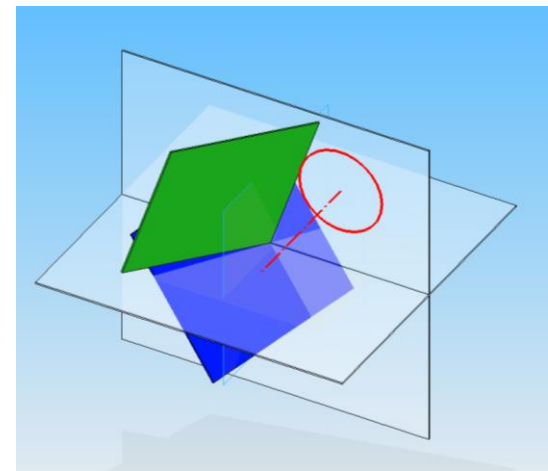
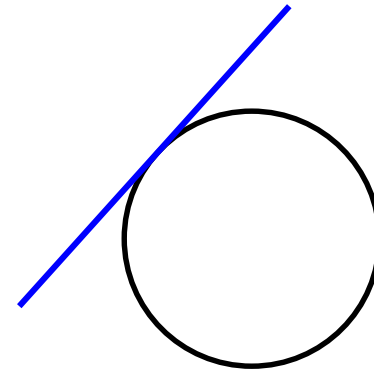
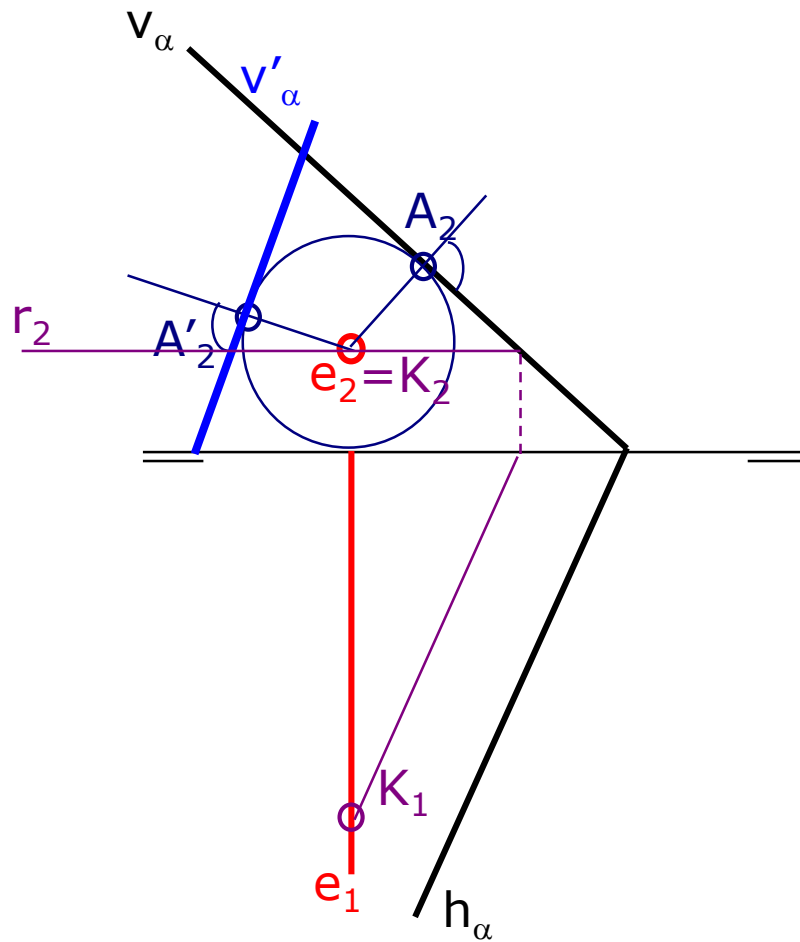

Revolution of a plane I

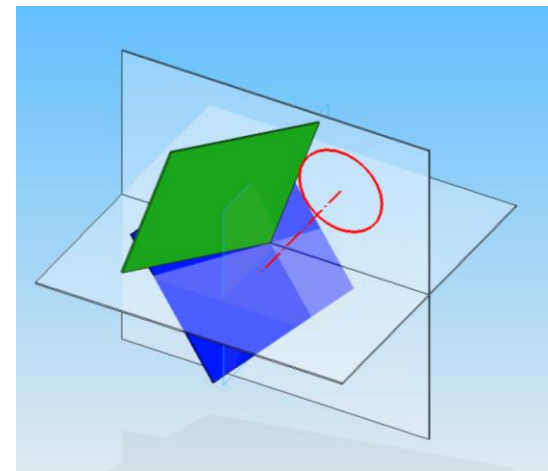
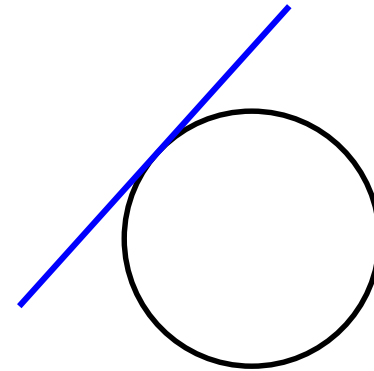
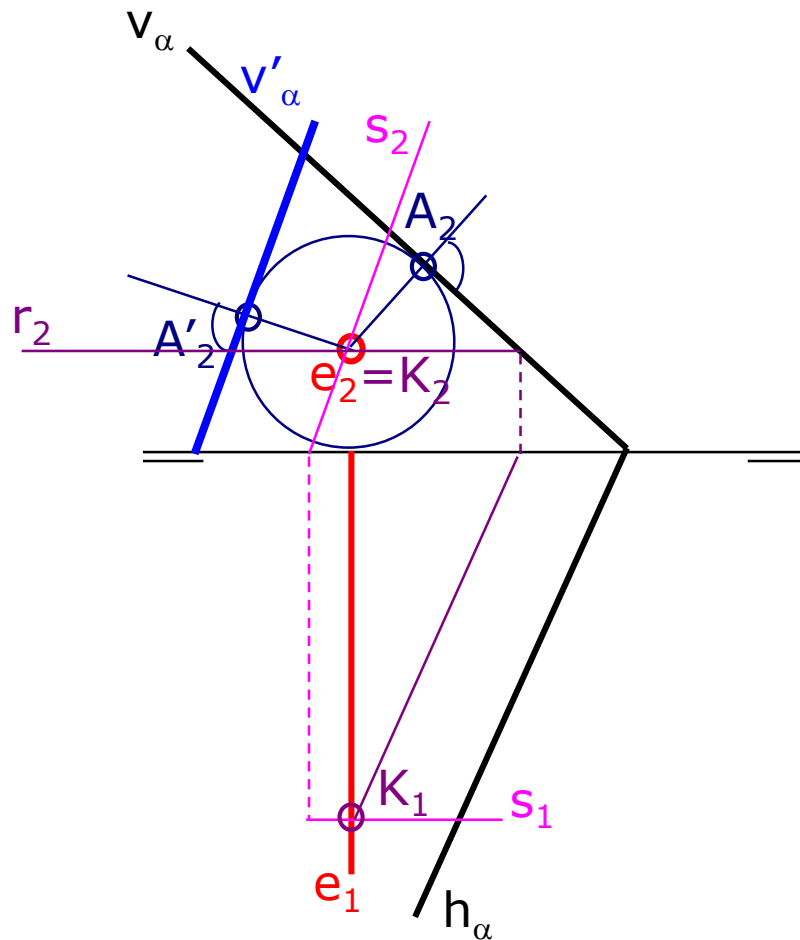

Revolution of a plane I

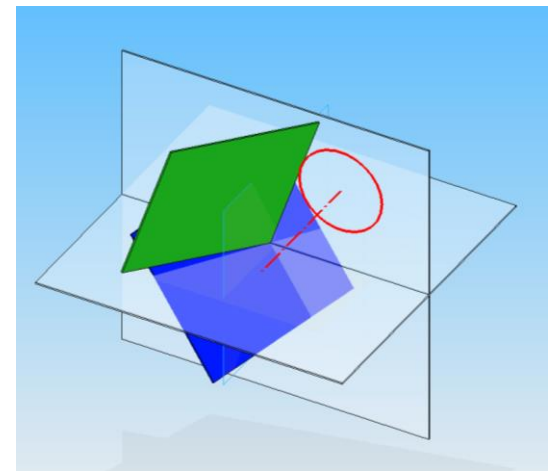
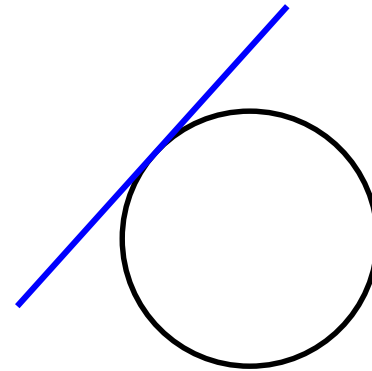
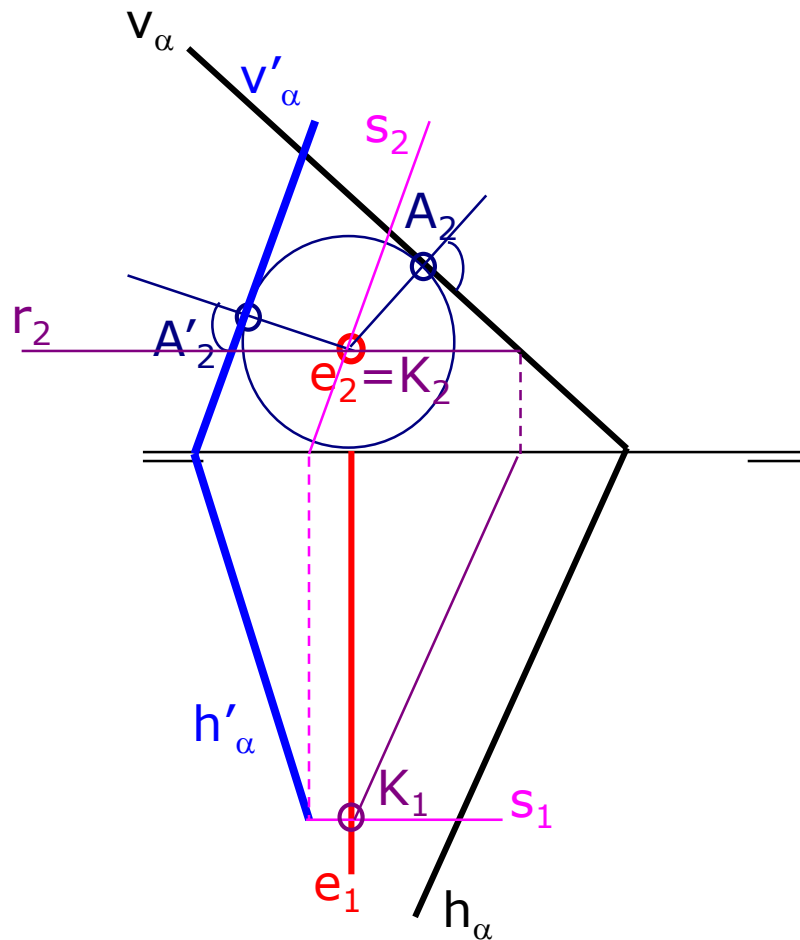

Revolution of a plane II

- A generic plane can be changed to a plane // to any projection plane with 2 rotations

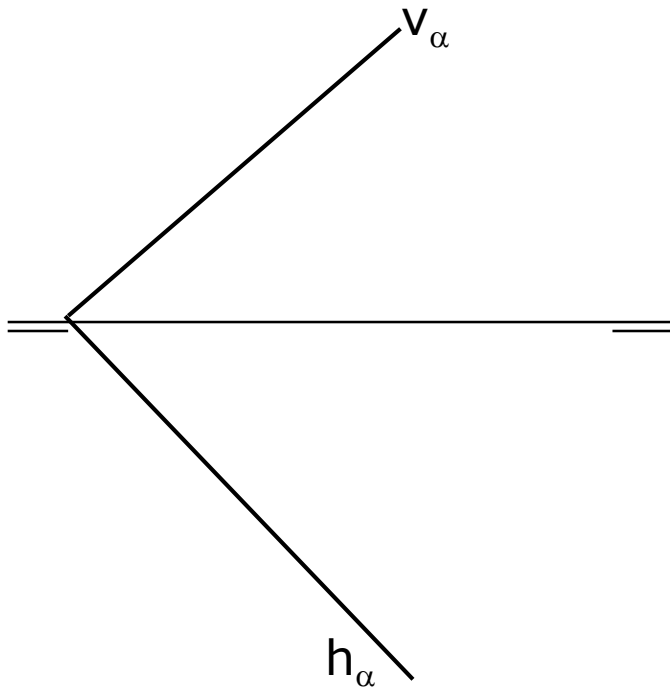

Revolution of a plane II

- A generic plane can be changed to a plane // to any projection plane with 2 rotations

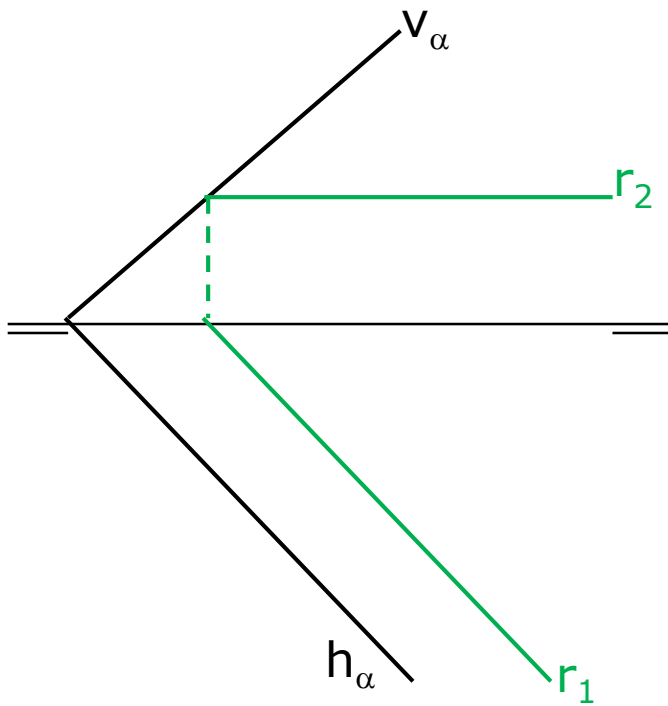

Revolution of a plane II

- A generic plane can be changed to a plane // to any projection plane with 2 rotations

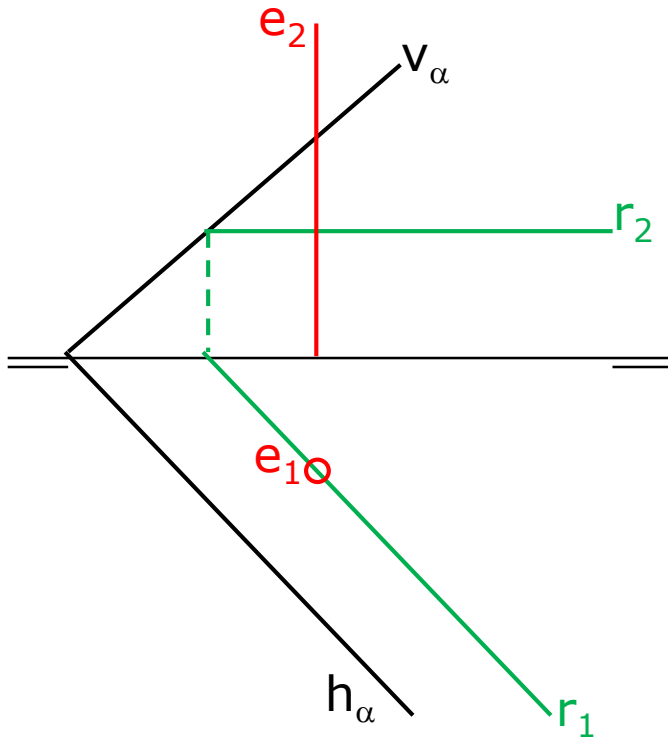

Revolution of a plane II

- A generic plane can be changed to a plane // to any projection plane with 2 rotations

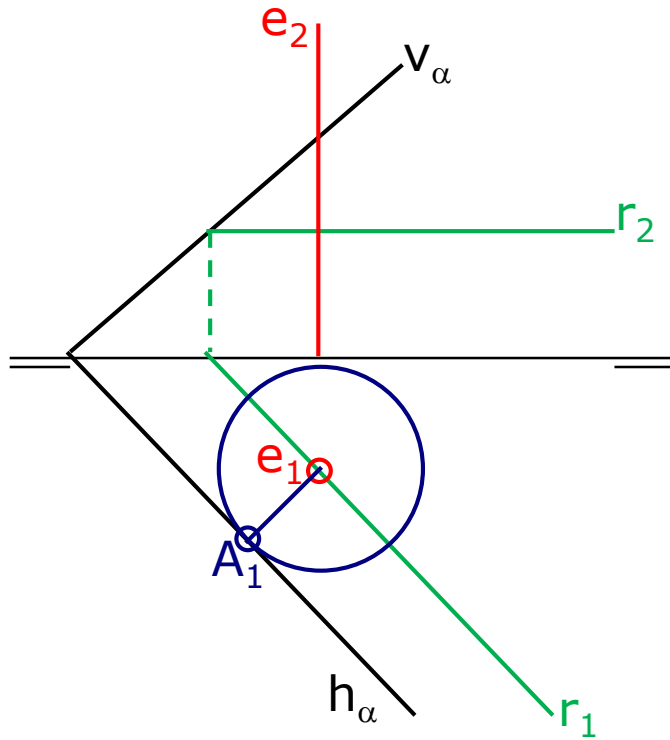

Revolution of a plane II

- A generic plane can be changed to a plane // to any projection plane with 2 rotations

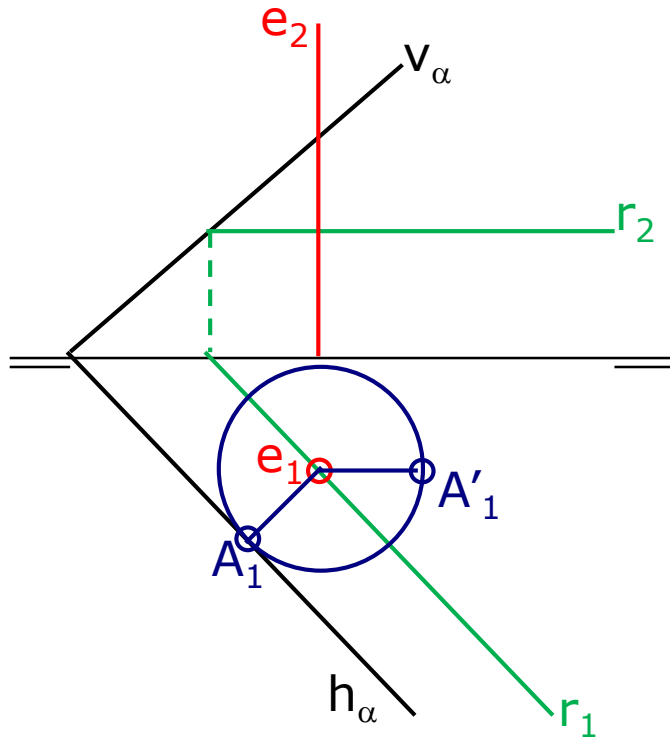

Revolution of a plane II

- A generic plane can be changed to a plane // to any projection plane with 2 rotations

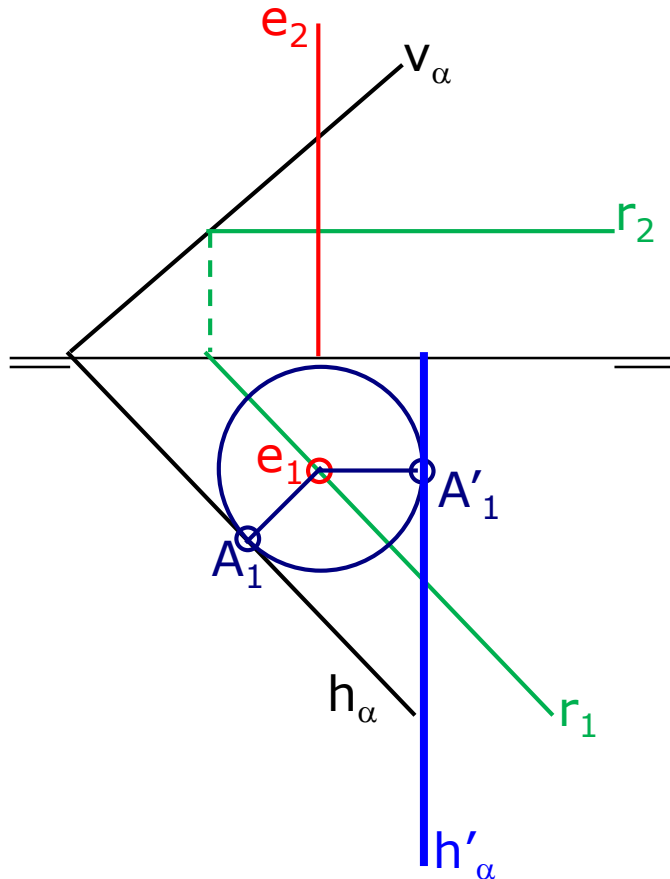

Revolution of a plane II

- A generic plane can be changed to a plane // to any projection plane with 2 rotations

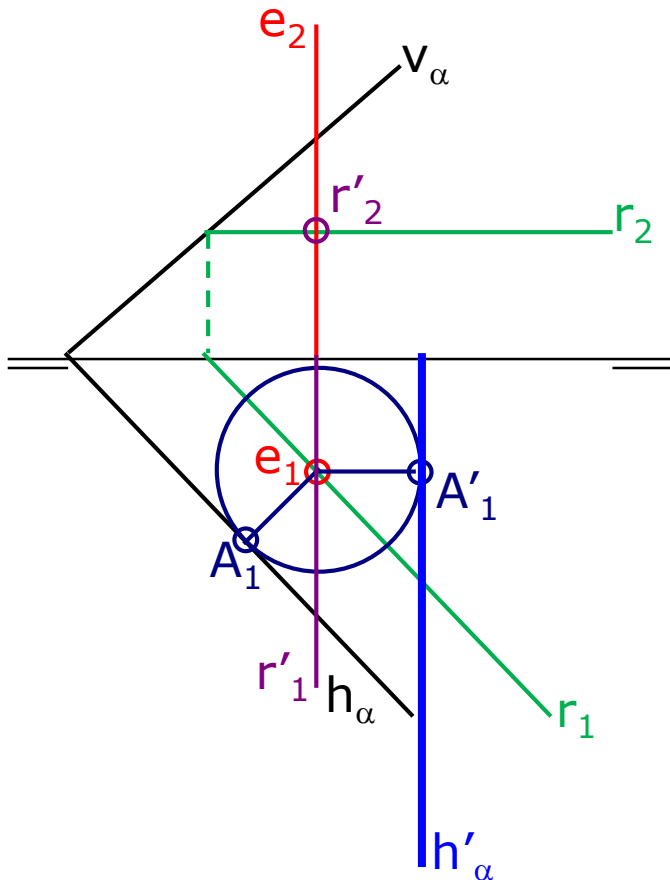

Revolution of a plane II

- A generic plane can be changed to a plane // to any projection plane with 2 rotations

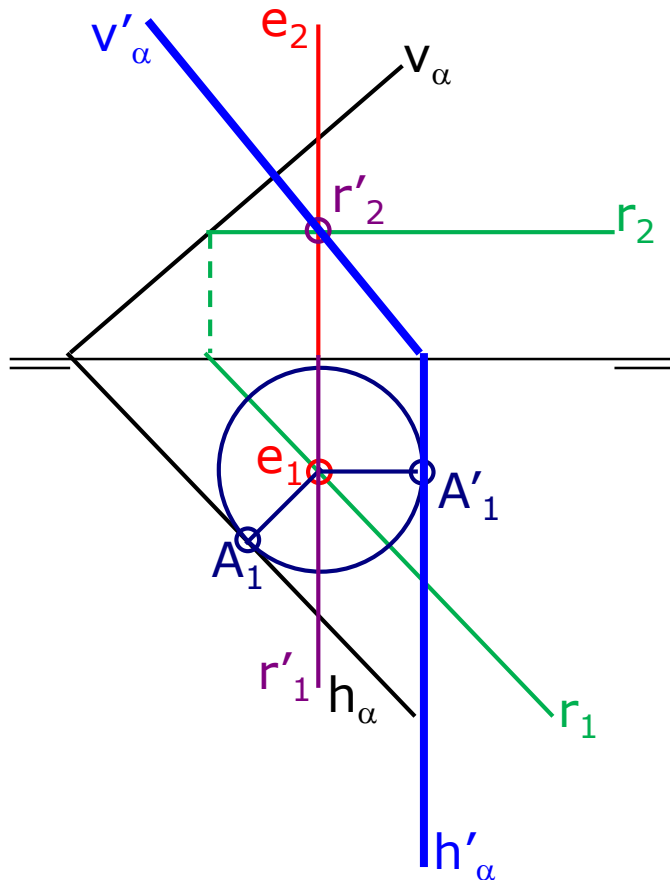

Revolution of a plane II

- A generic plane can be changed to a plane // to any projection plane with 2 rotations

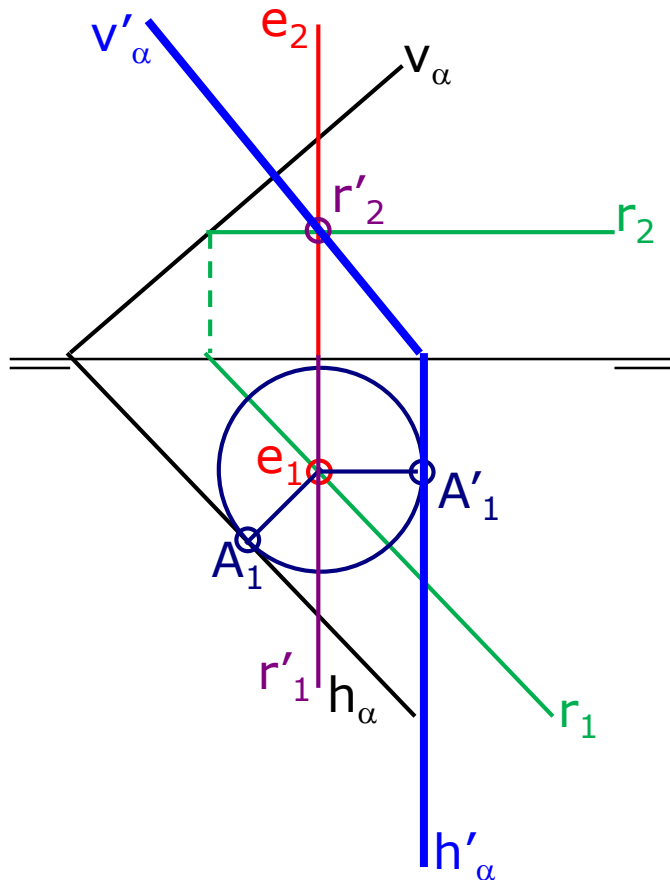

Revolution of a plane II

- A generic plane can be changed to a plane // to any projection plane with 2 rotations

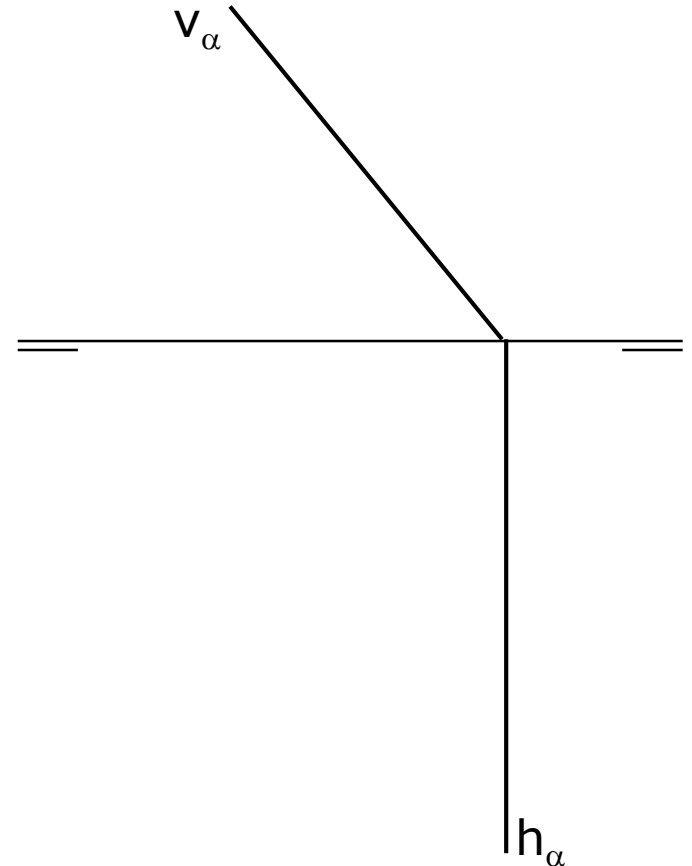
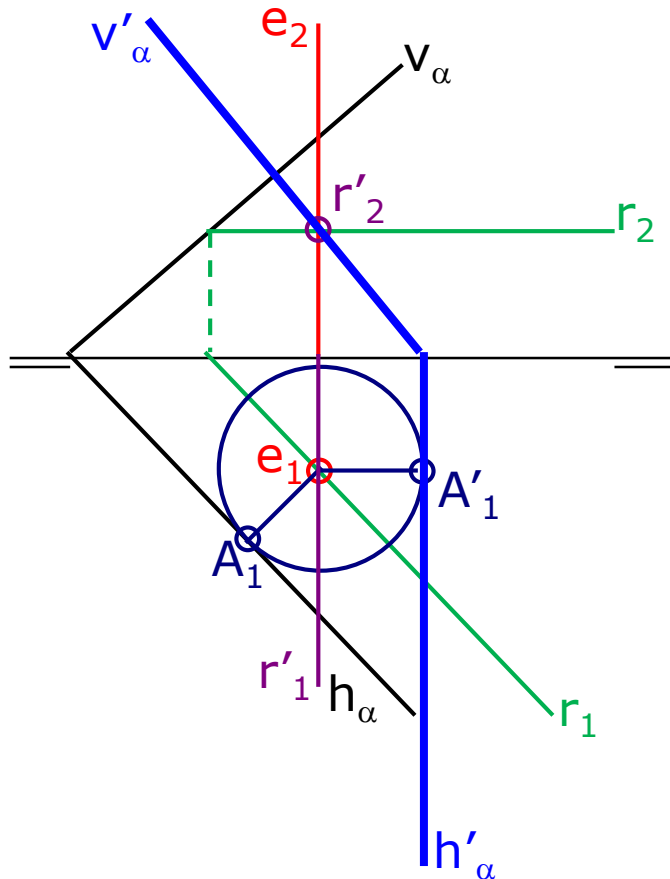

Revolution of a plane II

- A generic plane can be changed to a plane // to any projection plane with 2 rotations

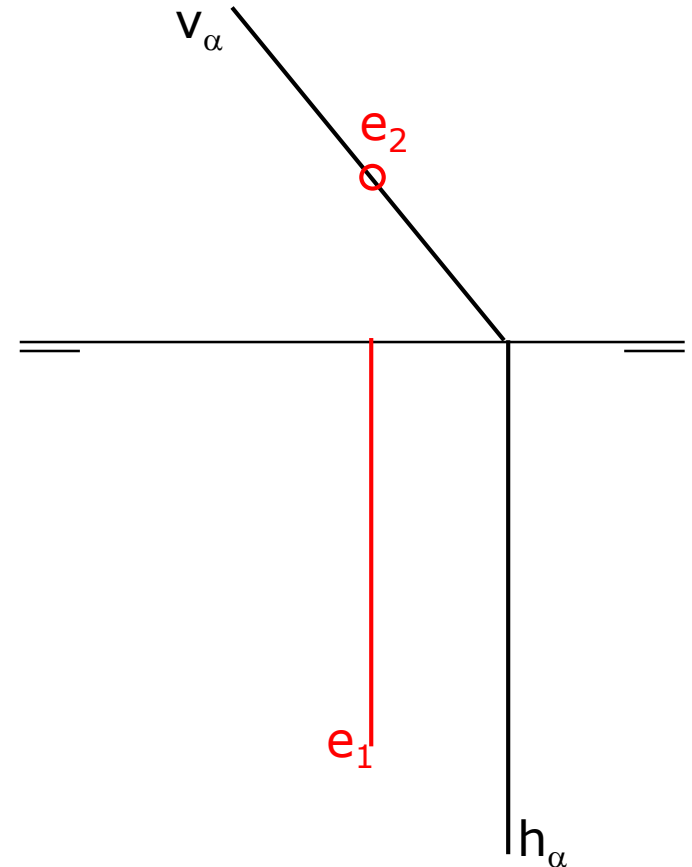
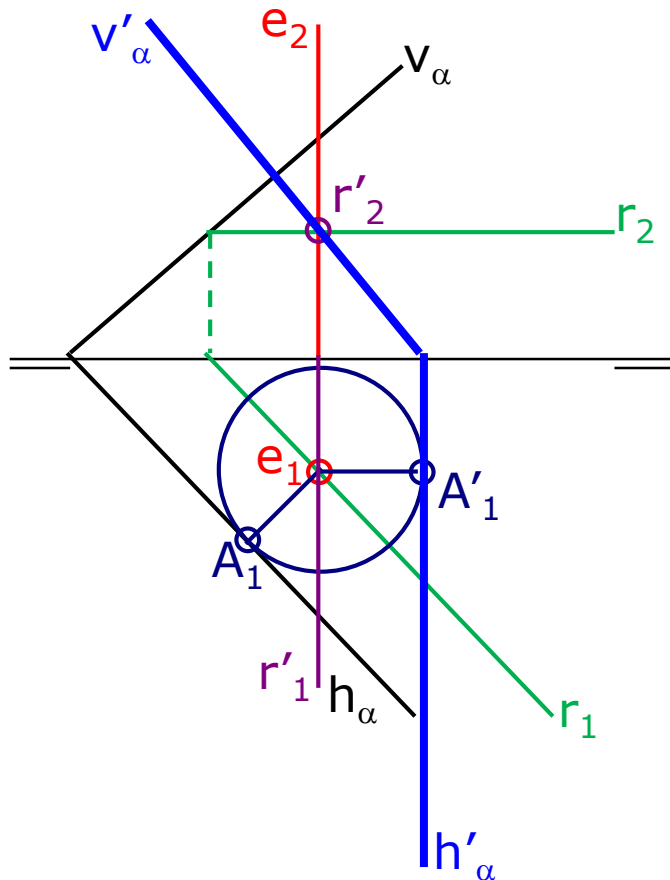

Revolution of a plane II

- A generic plane can be changed to a plane // to any projection plane with 2 rotations

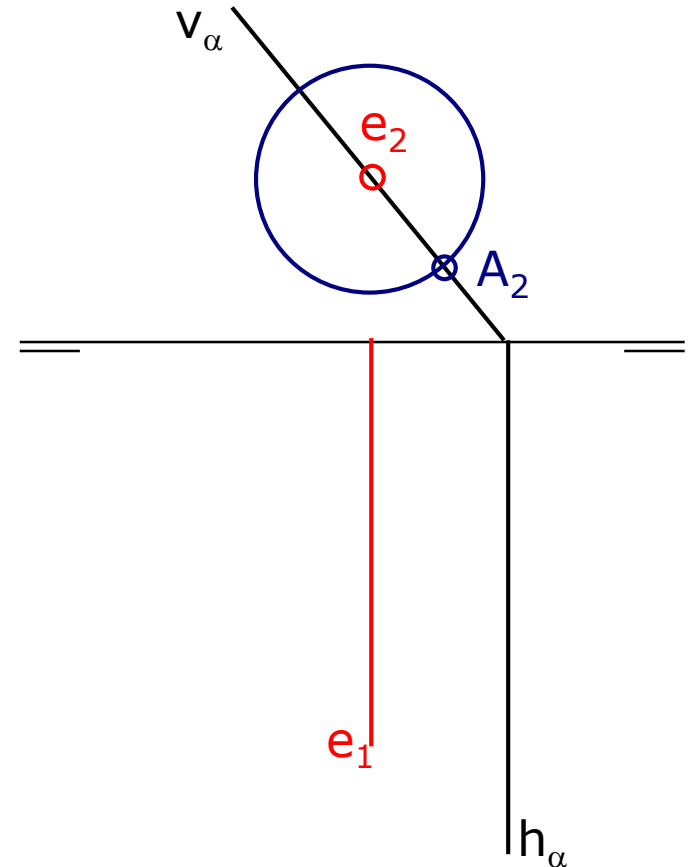
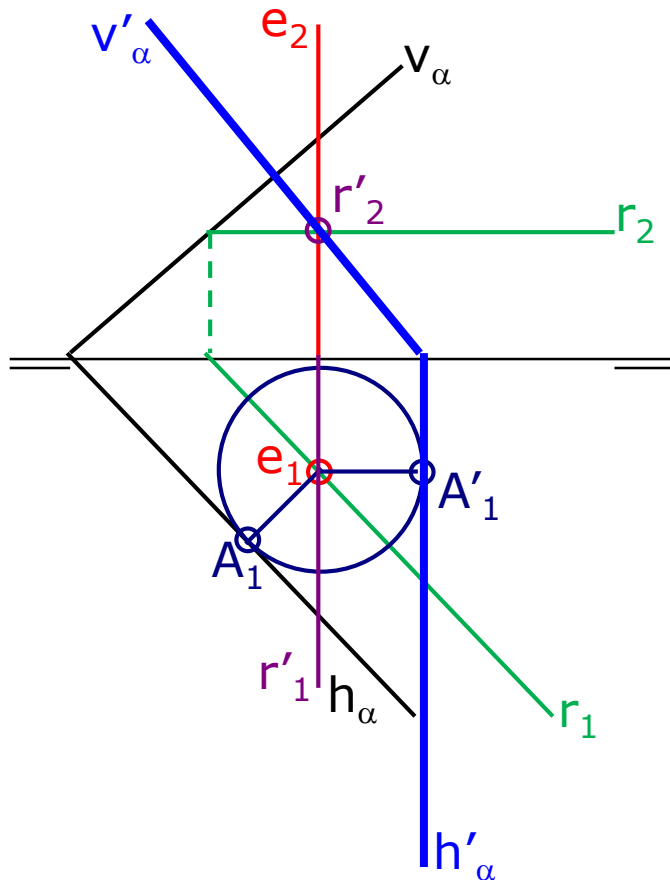

Revolution of a plane II

- A generic plane can be changed to a plane // to any projection plane with 2 rotations

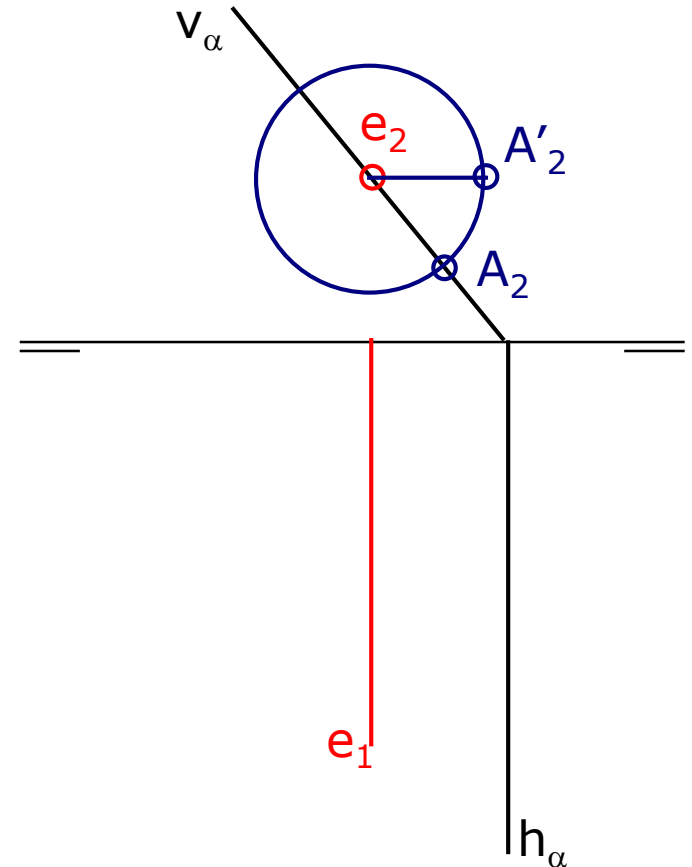
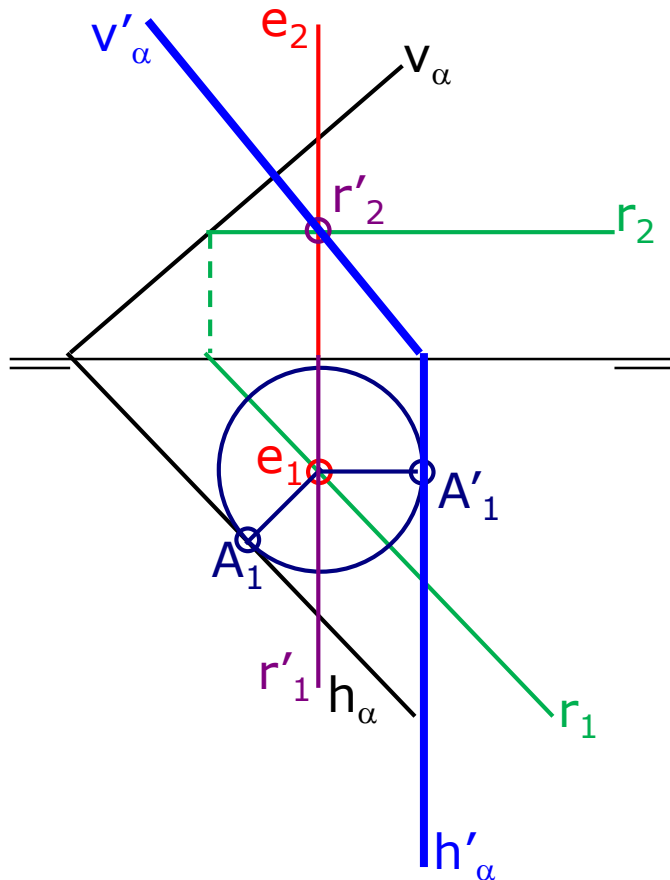

Revolution of a plane II

- A generic plane can be changed to a plane // to any projection plane with 2 rotations

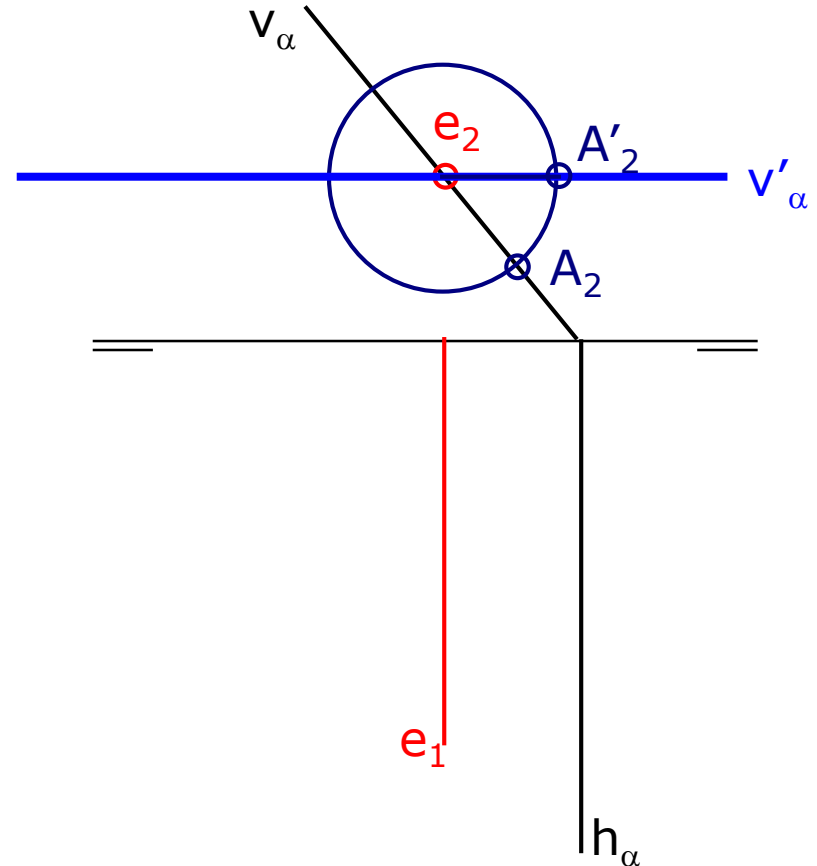
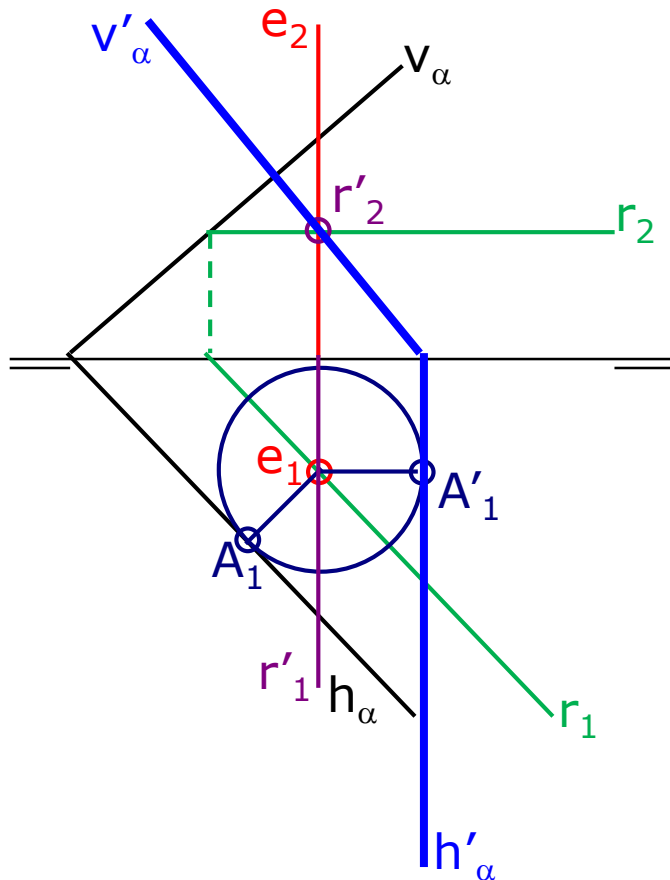

Example

Draw by means of revolution, an equilateral triangle of 40 mm side included in plane α . Side AB is included in a frontal line of the plane and the point B has less height than point A.

DATA: h_α forms -30° with the R.L. v_α forms 140° with the R.L. Point A is located 100mm of the intersection of the traces (measured over the horizontal and has a height of 40mm.

1. Situar el plano y los puntos A y B
2. Girar el plano alrededor del eje de punta e para obtener un plano vertical
3. Girar el plano alrededor del eje vertical e' para obtener un plano frontal
4. Por ser el plano frontal, las proyecciones verticales están en verdadera magnitud, por lo que es posible construir el triángulo equilátero y situar C
5. Deshacer el giro de C con respecto al eje e'
6. Deshacer el giro de C con respecto al eje e
7. Construir las proyecciones originales del triángulo

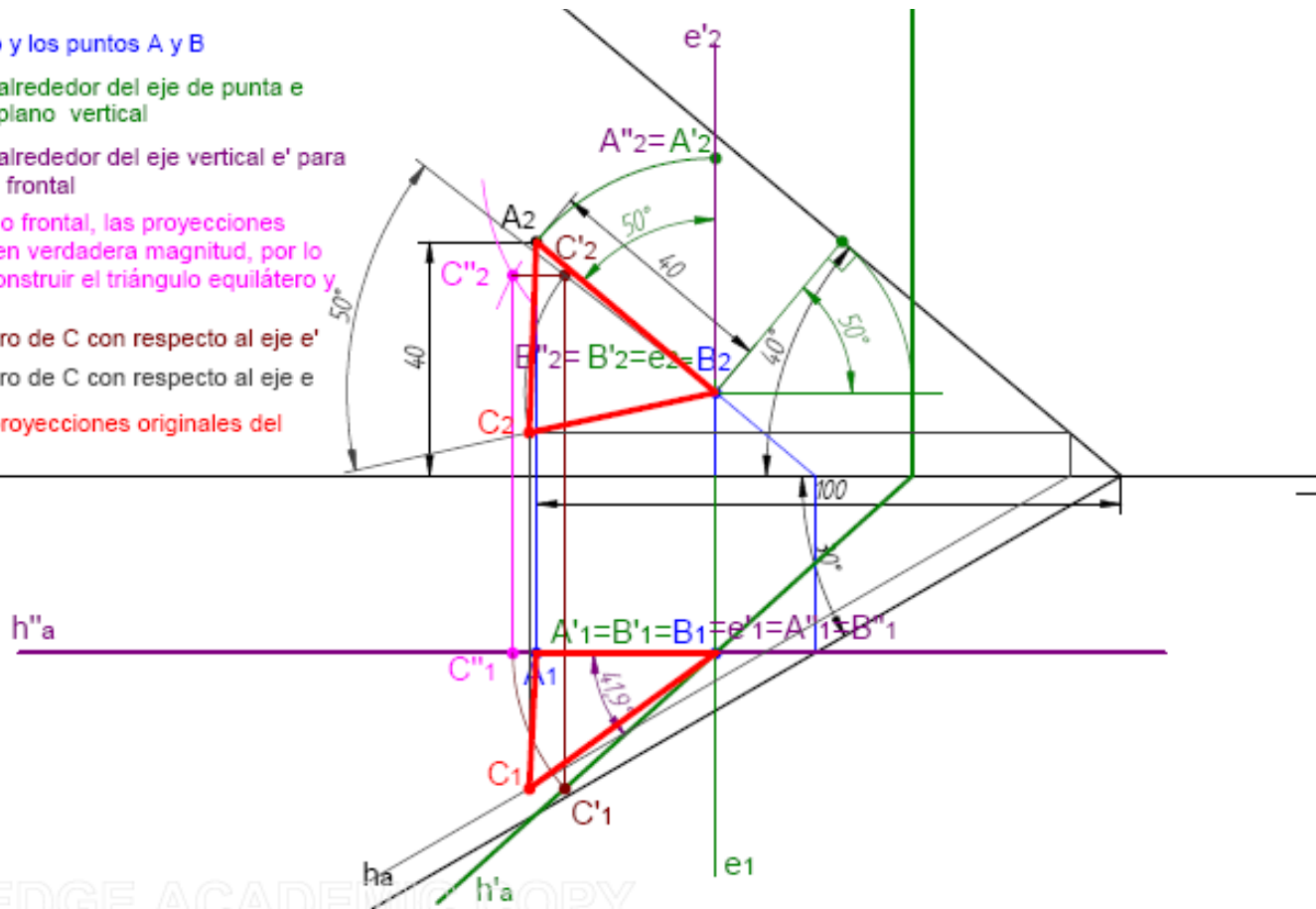

Change of planes

- **Procedure:** leave the space elements unchanged and use other projection planes where the distances are in true magnitude
- Change of planes of a point:

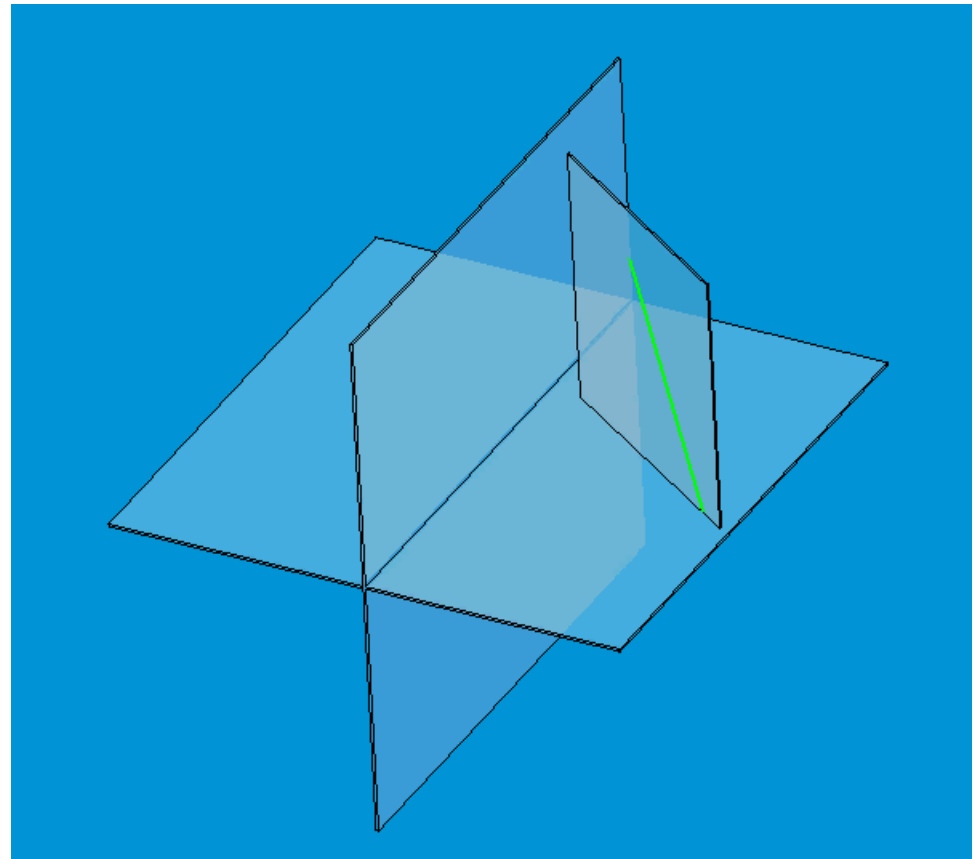
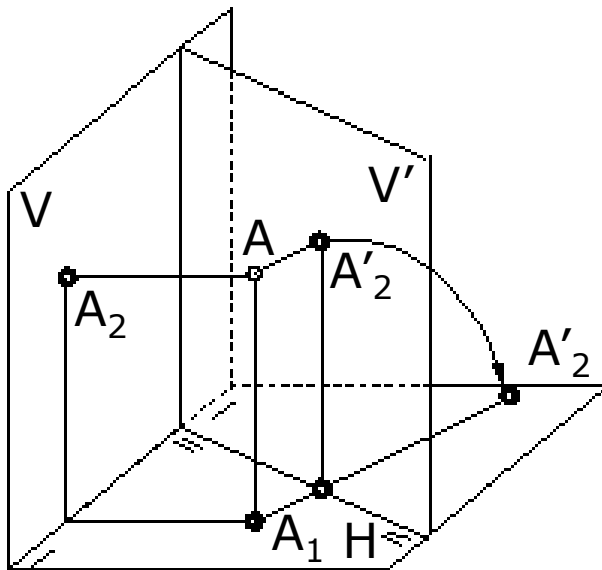

Change of the vertical projection plane $V \rightarrow V'$

(V' will also be $\perp H$)

- The **horizontal** projection is maintained
- The new **vertical** projection **keeps the same height**

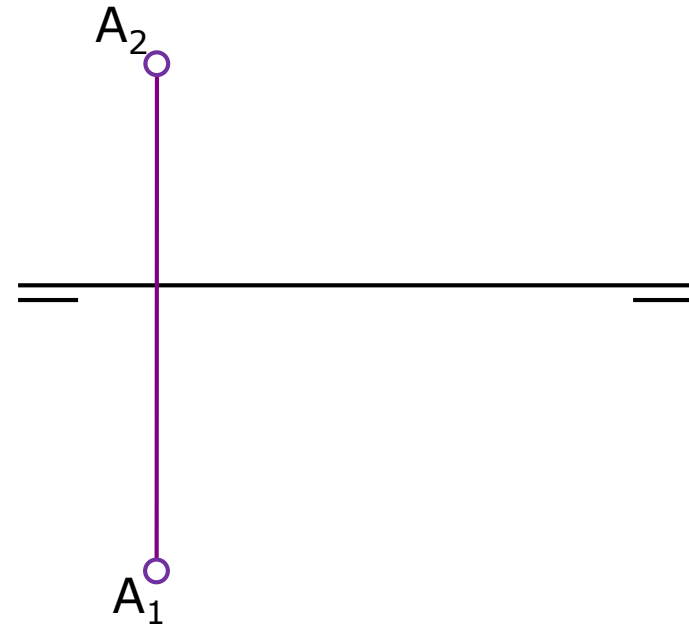
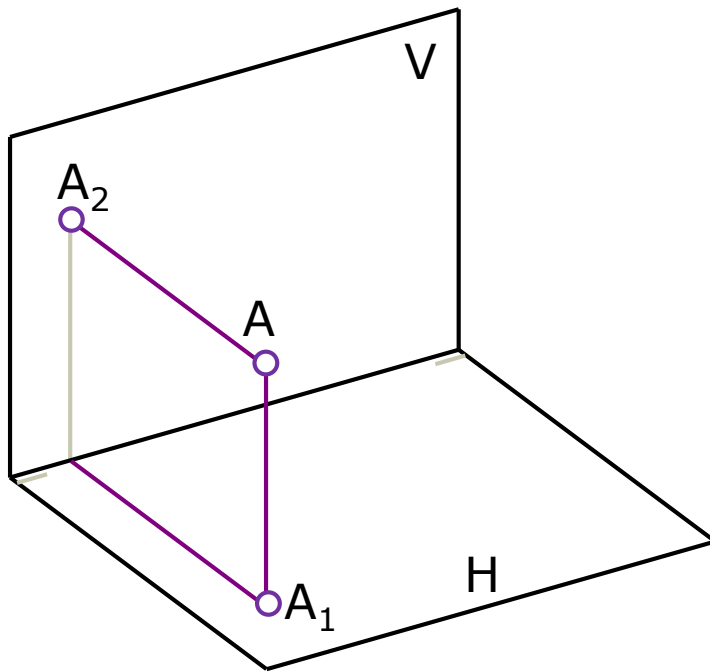

Change of the vertical projection plane $V \rightarrow V'$

(V' will also be $\perp H$)

- The **horizontal** projection is maintained
- The new **vertical** projection **keeps the same height**

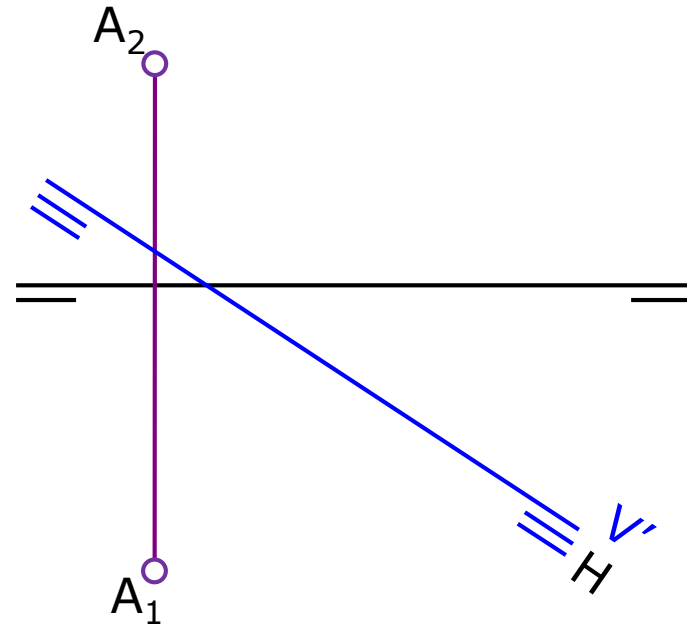
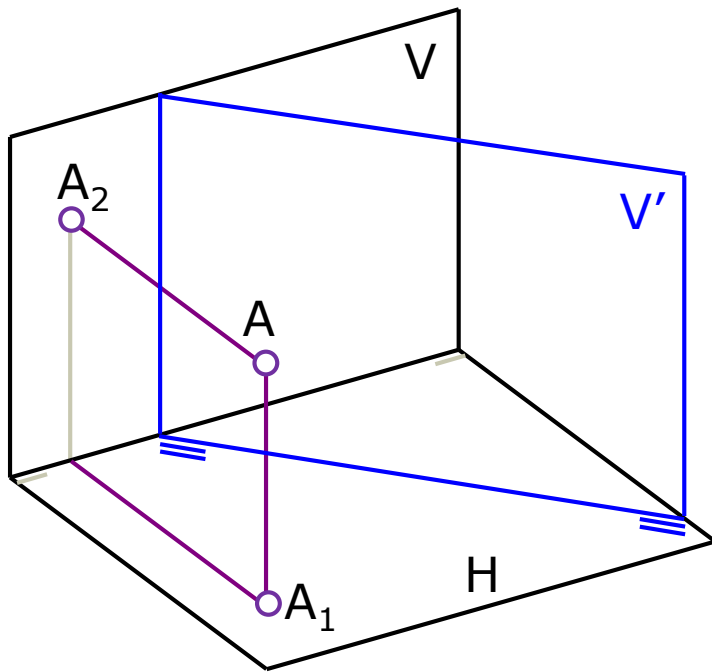

Change of the vertical projection plane $V \rightarrow V'$

(V' will also be $\perp H$)

- The **horizontal** projection is maintained
- The new **vertical** projection **keeps the same height**

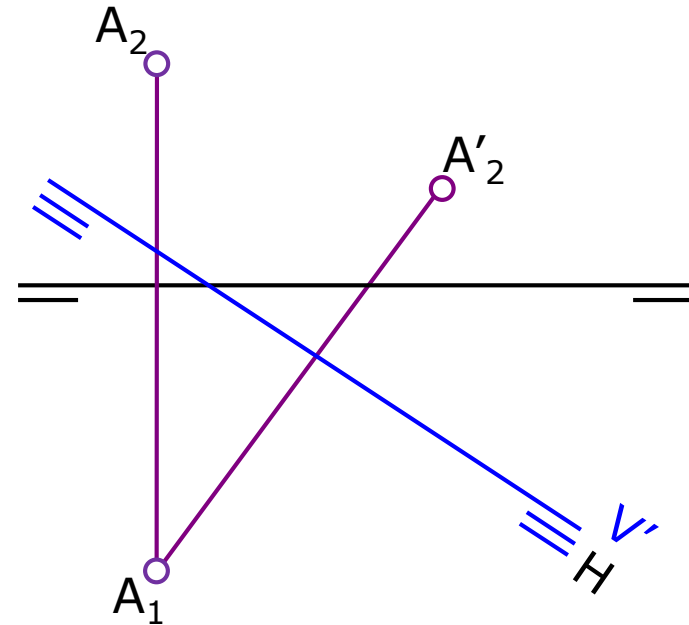
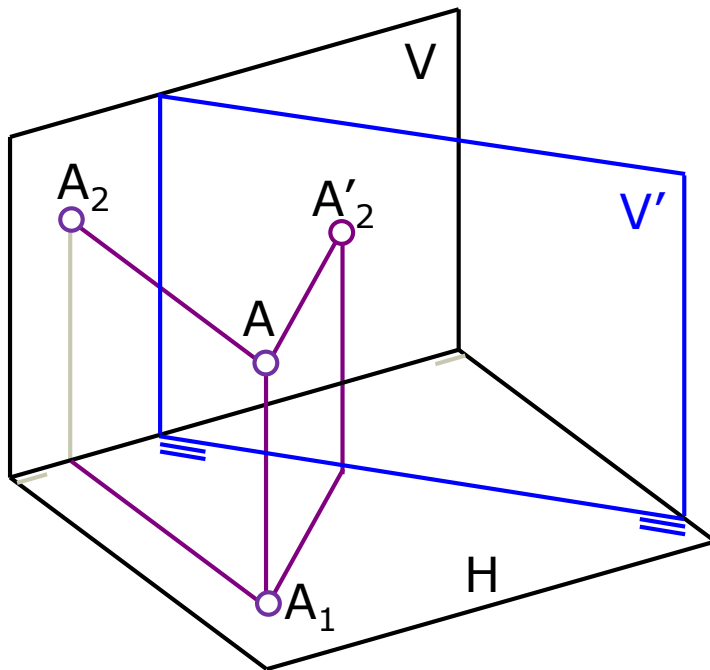

Change of the vertical projection plane $V \rightarrow V'$

(V' will also be $\perp H$)

- The **horizontal** projection is maintained
- The new **vertical** projection **keeps the same height**

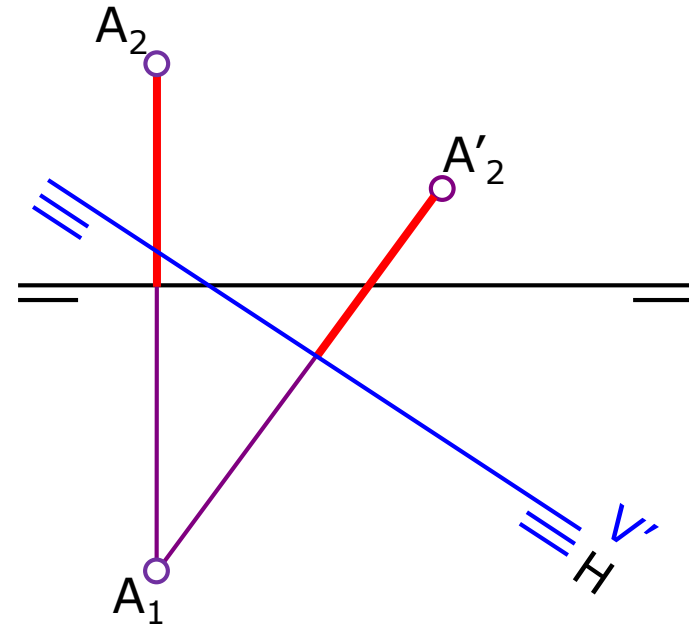
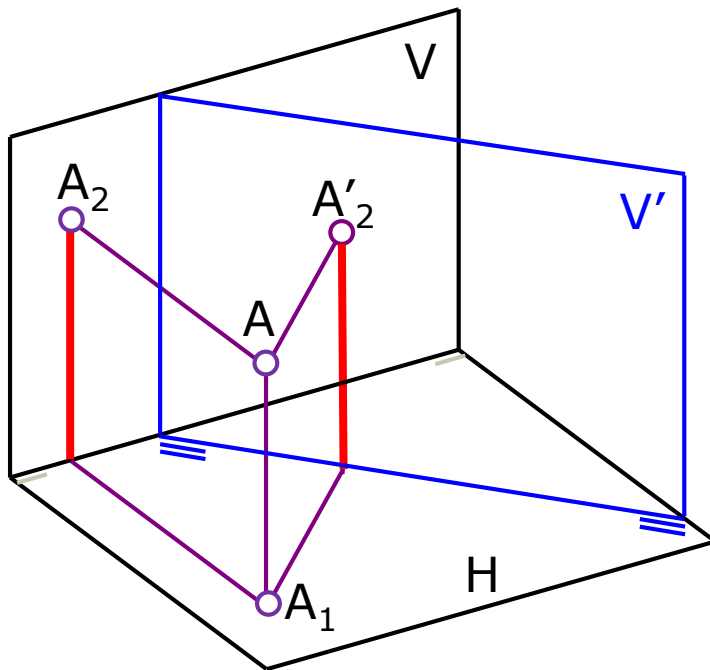

Change of the horizontal projection plane ($H \rightarrow H'$)

(H' will also be $\perp V$)

- The **vertical** projection is maintained
- The new **horizontal** projection **keeps** the same depth

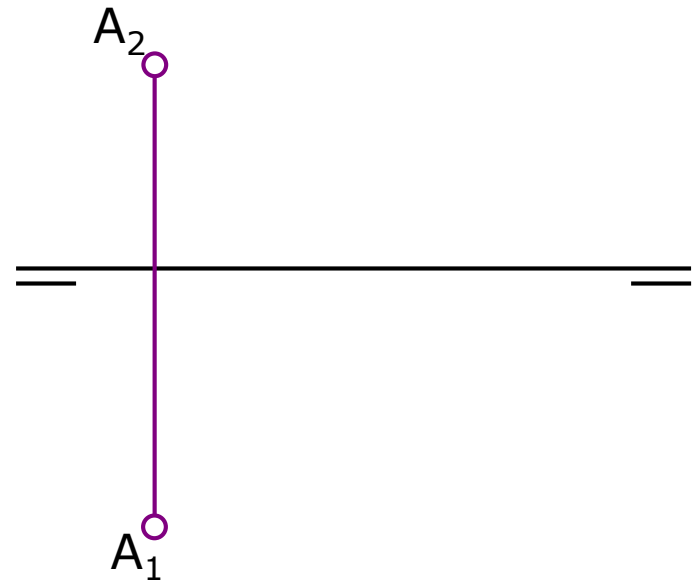
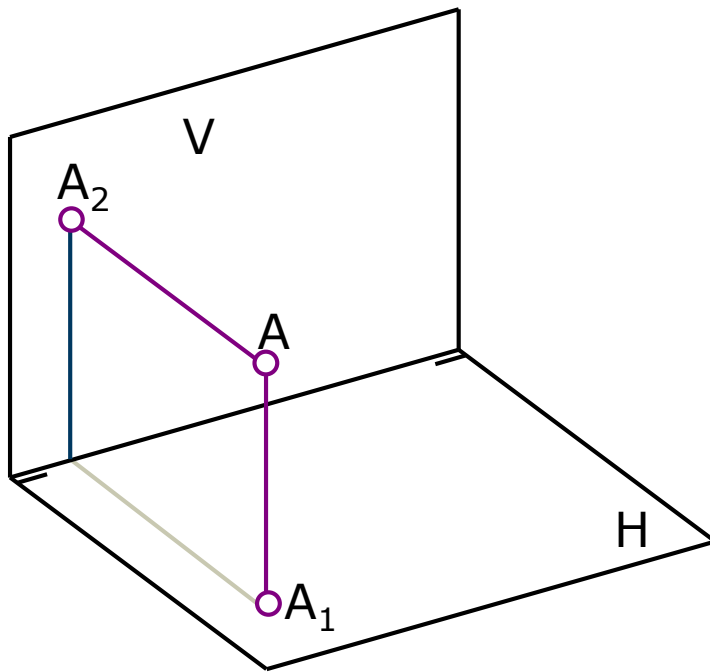

Change of the horizontal projection plane ($H \rightarrow H'$)

(H' will also be $\perp V$)

- The **vertical** projection is maintained
- The new **horizontal** projection **keeps** the same depth

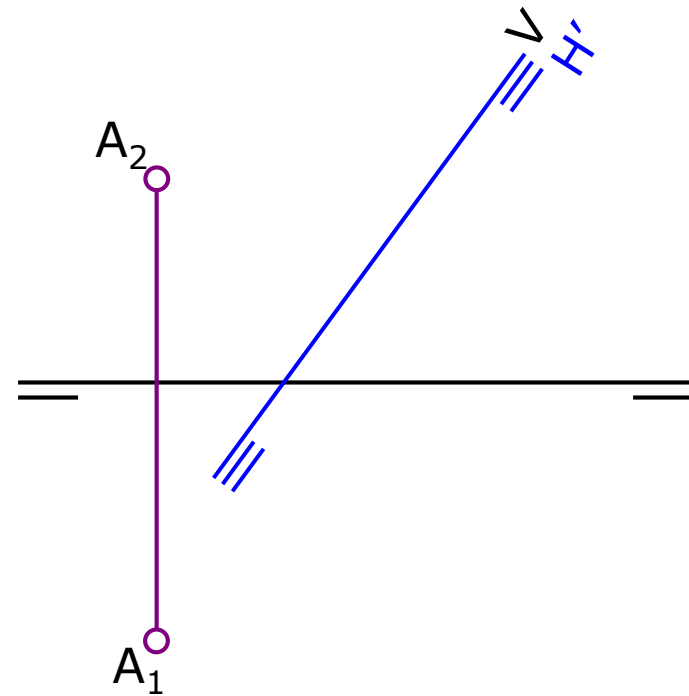
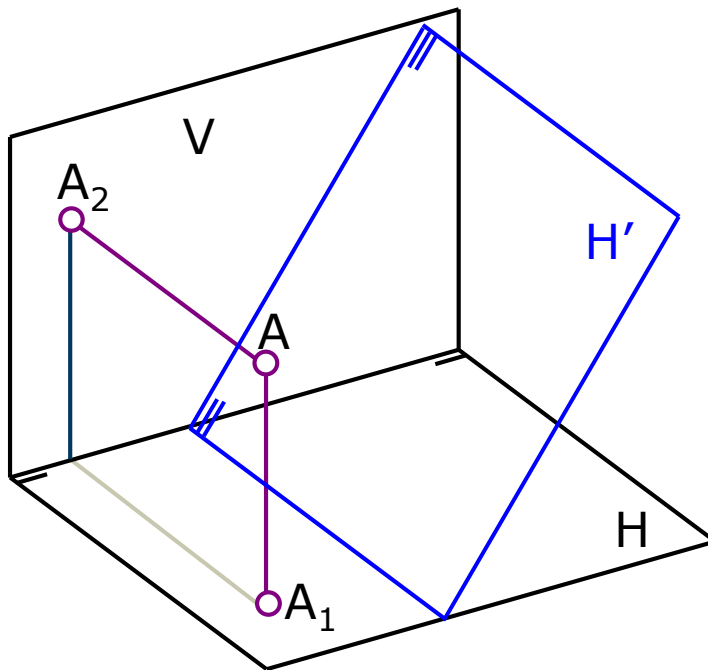

Change of the horizontal projection plane ($H \rightarrow H'$)

(H' will also be $\perp V$)

- The **vertical** projection is maintained
- The new **horizontal** projection **keeps** the same depth

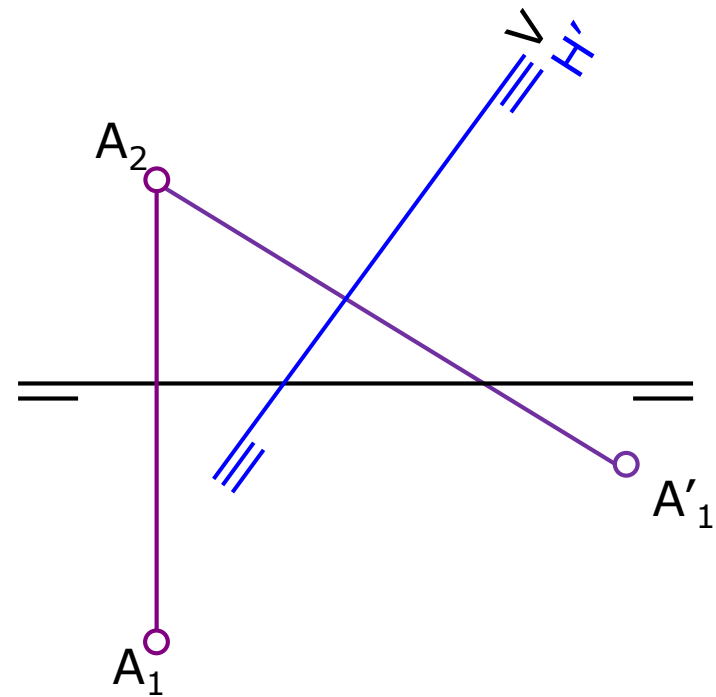
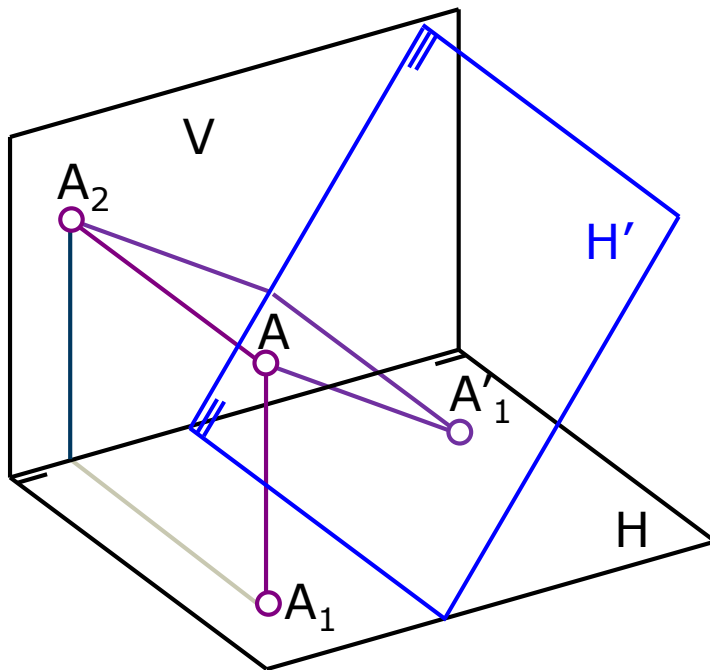

Change of the horizontal projection plane ($H \rightarrow H'$)

(H' will also be $\perp V$)

- The **vertical** projection is maintained
- The new **horizontal** projection **keeps** the same depth

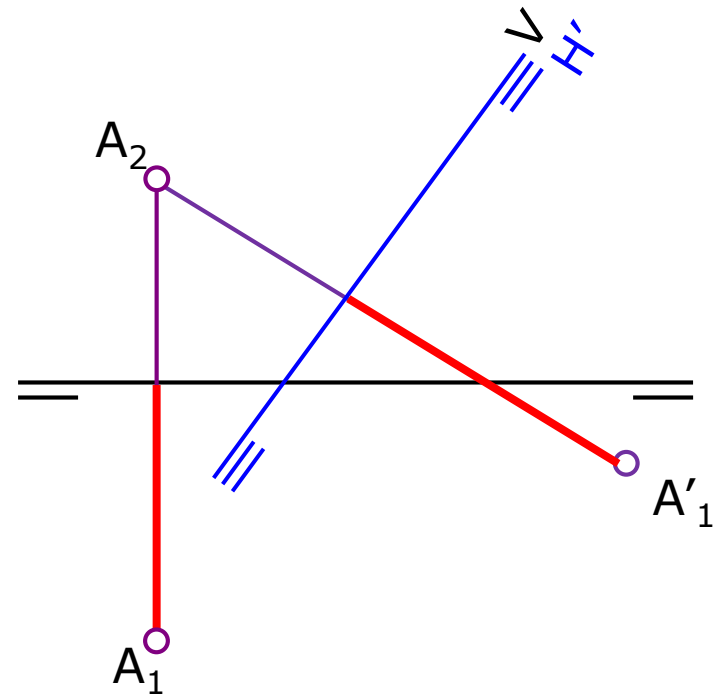
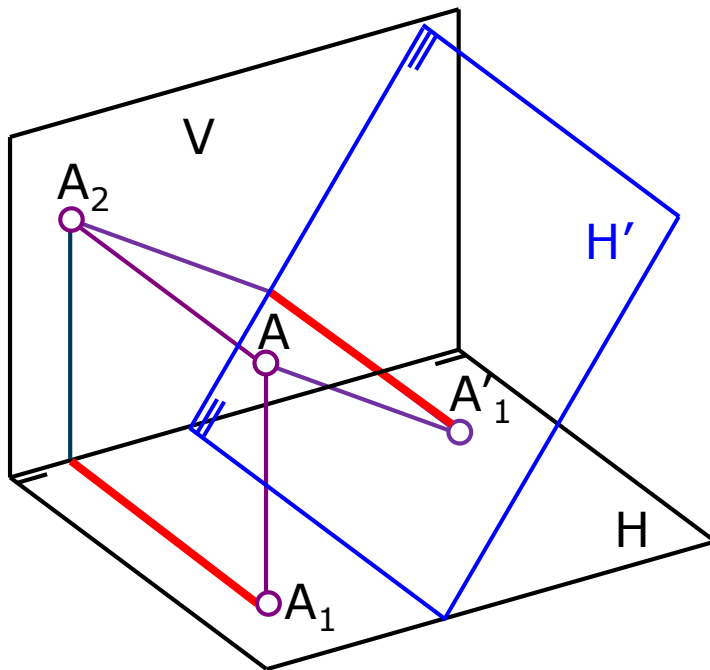

Change of planes of a line

- Transform a line in a horizontal line, by means of change of the horizontal plane ($H \rightarrow H'$), such that the new R.L. is // to r_2

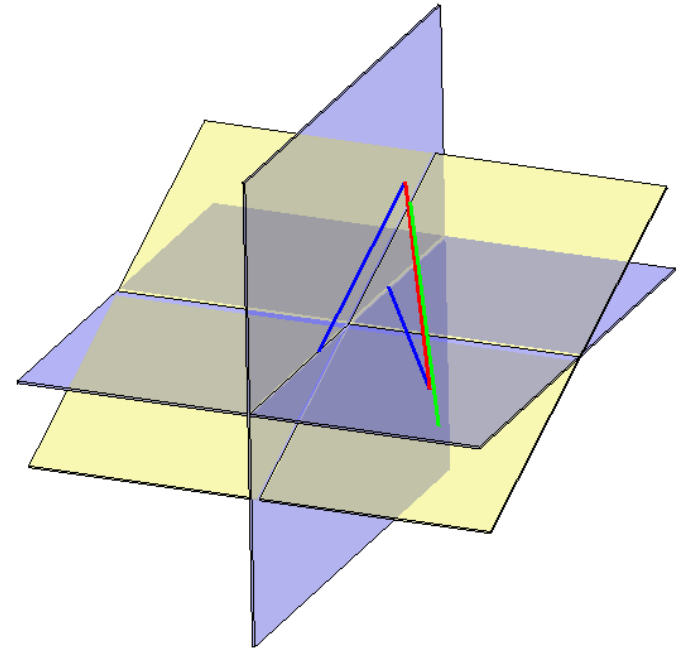
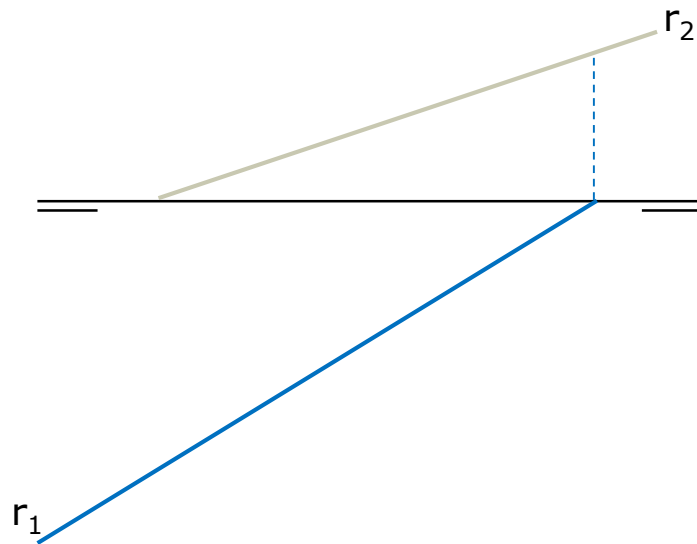

Change of planes of a line

- Transform a line in a horizontal line, by means of change of the horizontal plane ($H \rightarrow H'$), such that the new R.L. is // to r_2

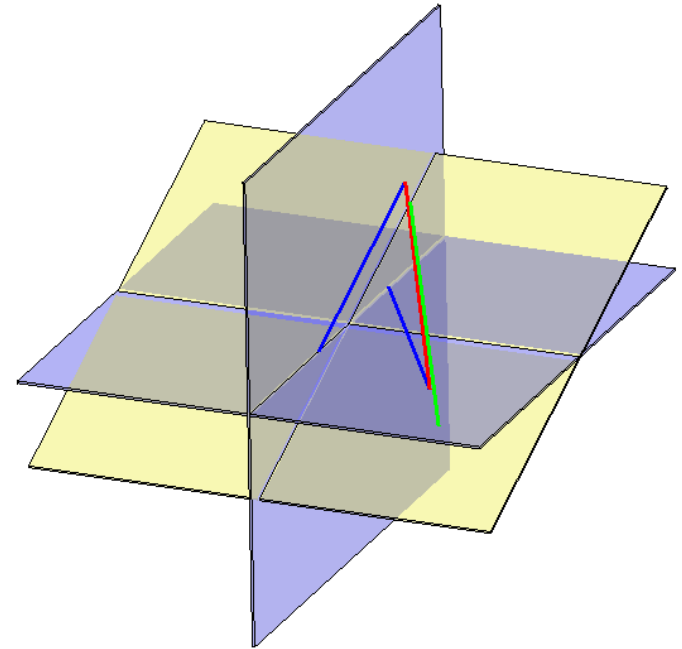
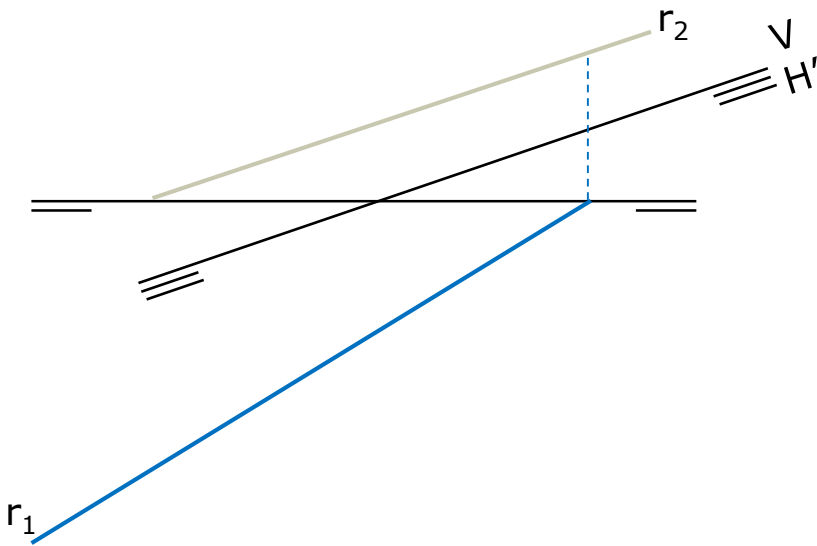

Change of planes of a line

- Transform a line in a horizontal line, by means of change of the horizontal plane ($H \rightarrow H'$), such that the new R.L. is // to r_2

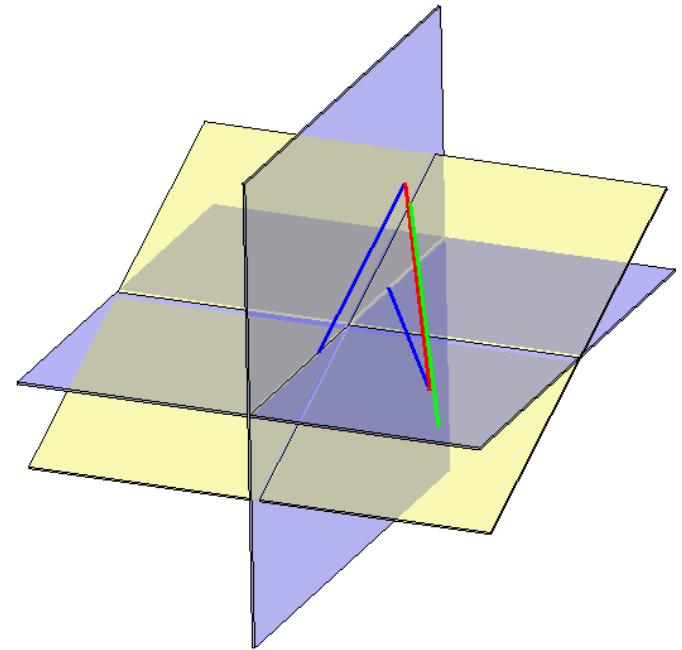
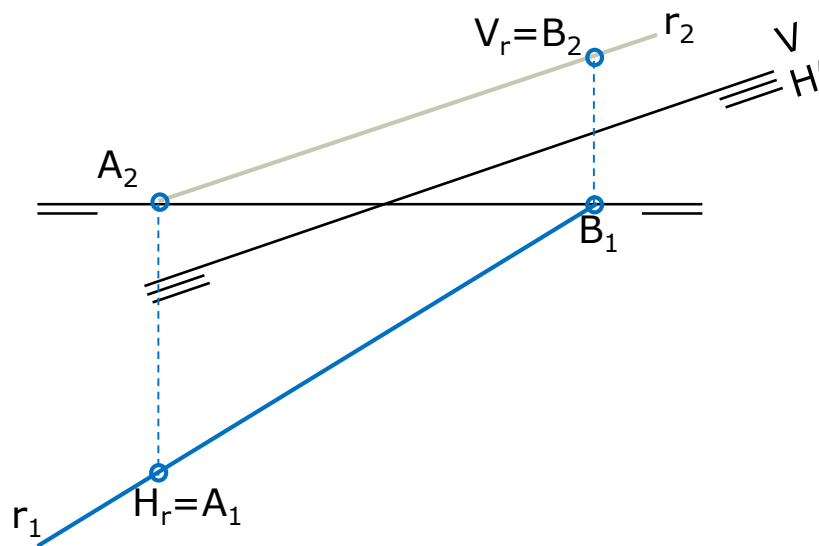

Change of planes of a line

- Transform a line in a horizontal line, by means of change of the horizontal plane ($H \rightarrow H'$), such that the new R.L. is // to r_2

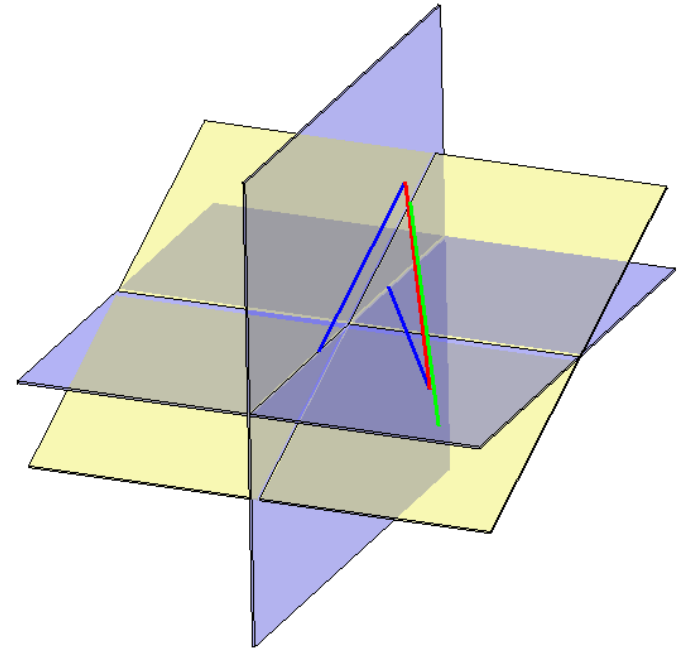
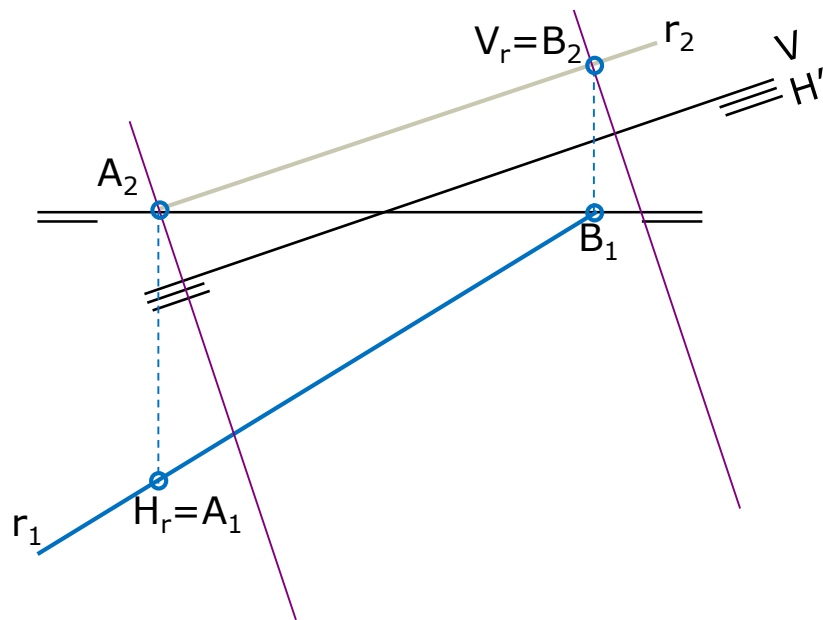

Change of planes of a line

- Transform a line in a horizontal line, by means of change of the horizontal plane ($H \rightarrow H'$), such that the new R.L. is // to r_2

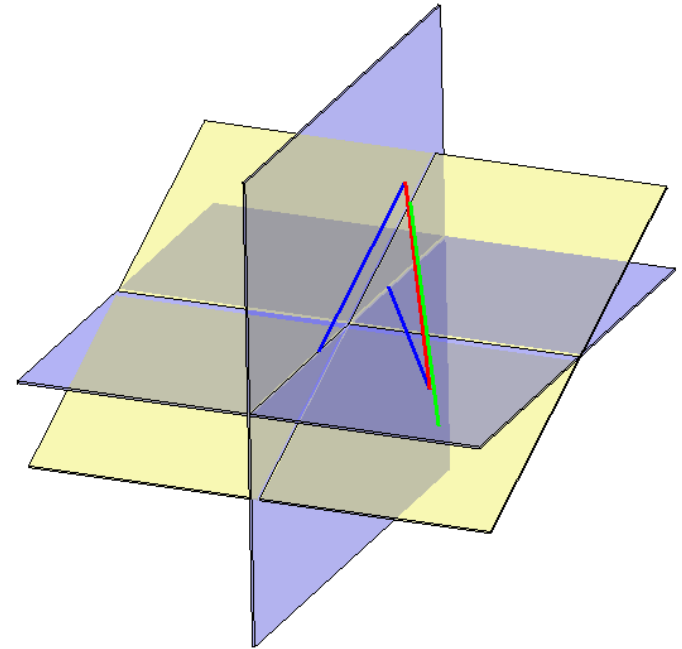
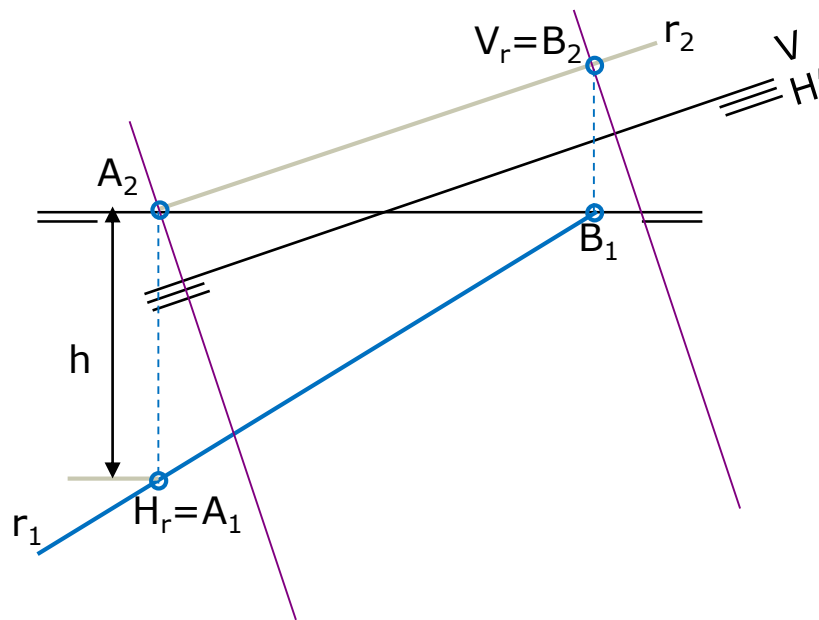

Change of planes of a line

- Transform a line in a horizontal line, by means of change of the horizontal plane ($H \rightarrow H'$), such that the new R.L. is // to r_2

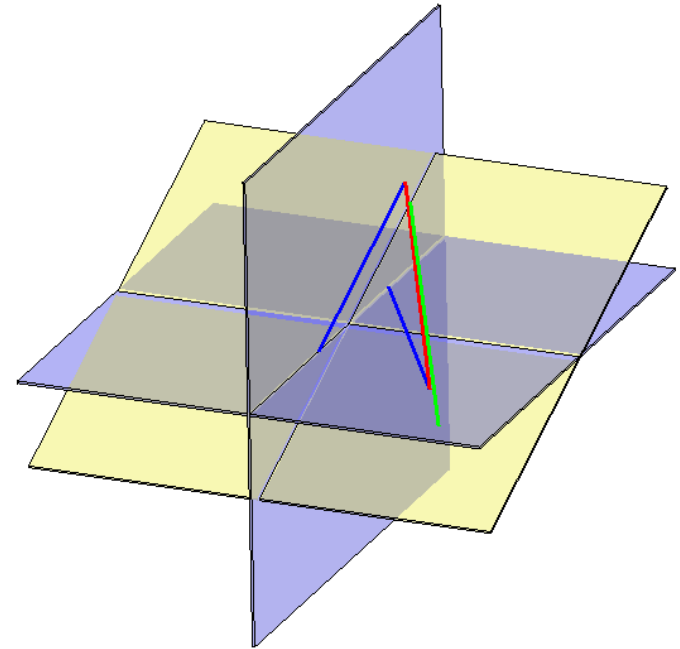
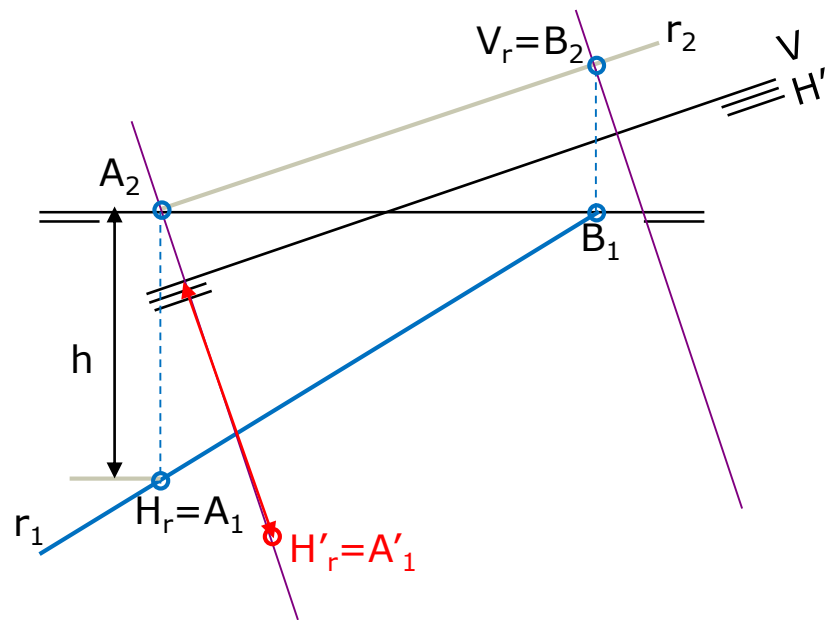

Change of planes of a line

- Transform a line in a horizontal line, by means of change of the horizontal plane ($H \rightarrow H'$), such that the new R.L. is // to r_2

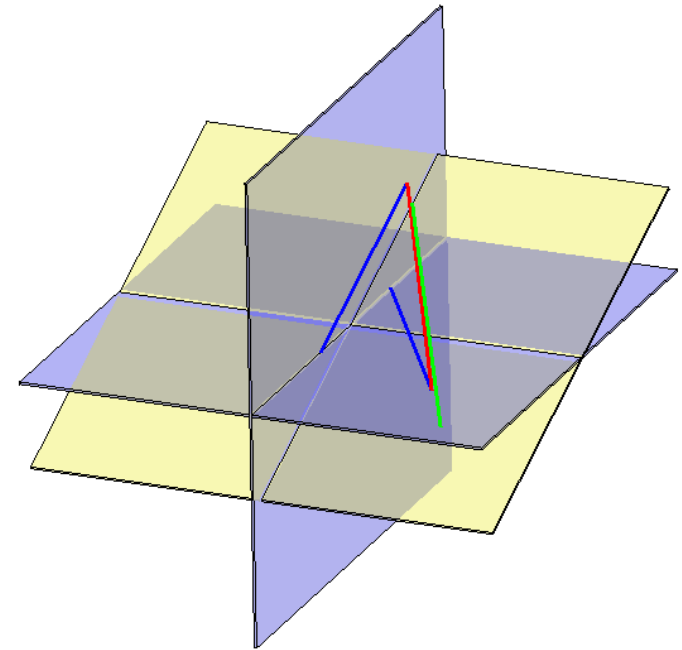
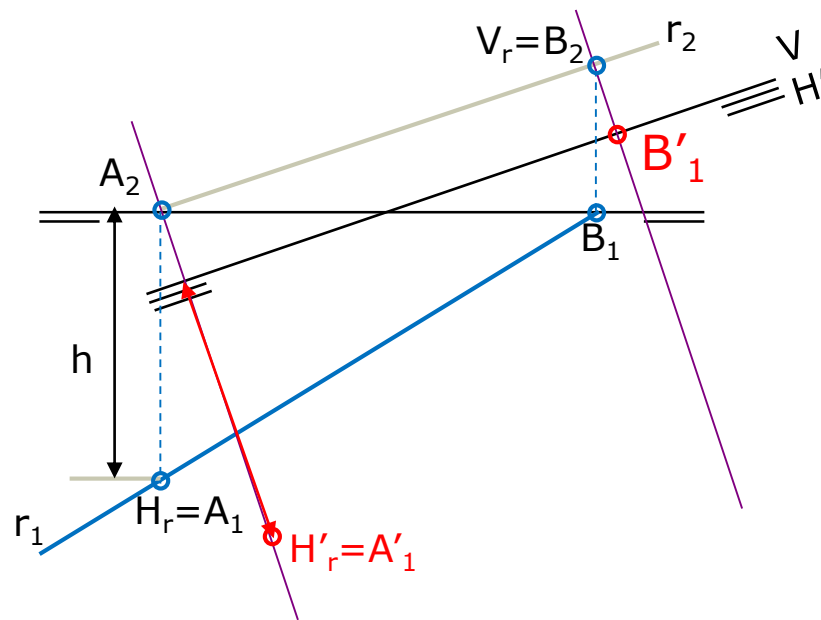

Change of planes of a line

- Transform a line in a horizontal line, by means of change of the horizontal plane ($H \rightarrow H'$), such that the new R.L. is // to r_2

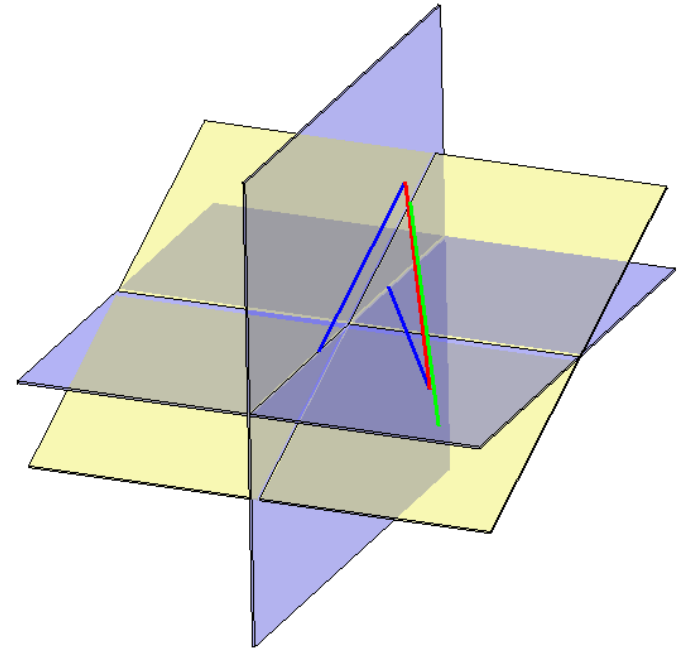
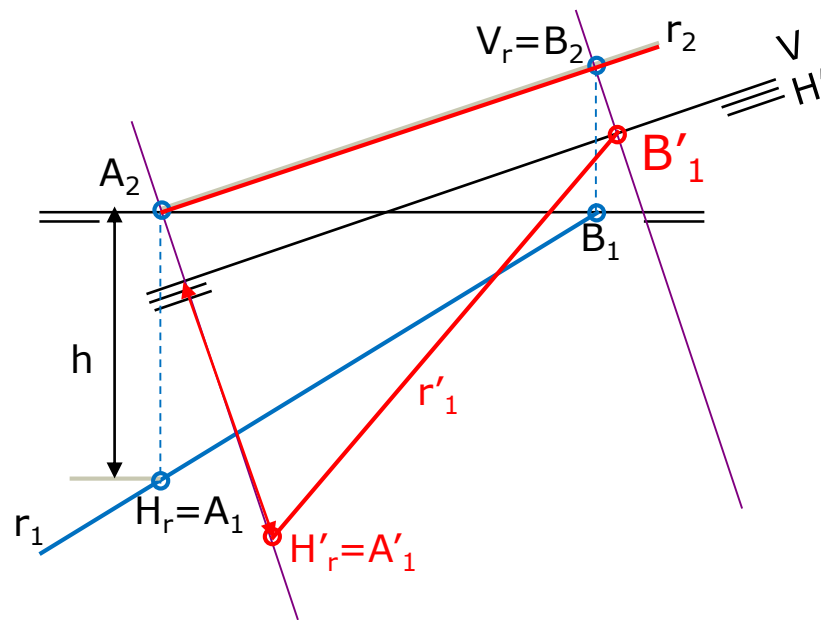

Change of planes of a line

□ Transform a line in a horizontal line, by means of change of the horizontal plane ($H \rightarrow H'$), such that the new R.L. is // to r_2

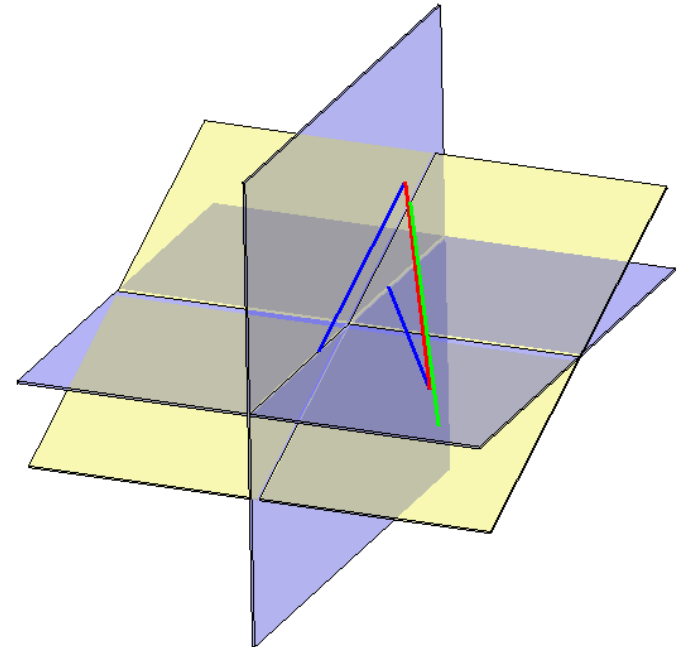
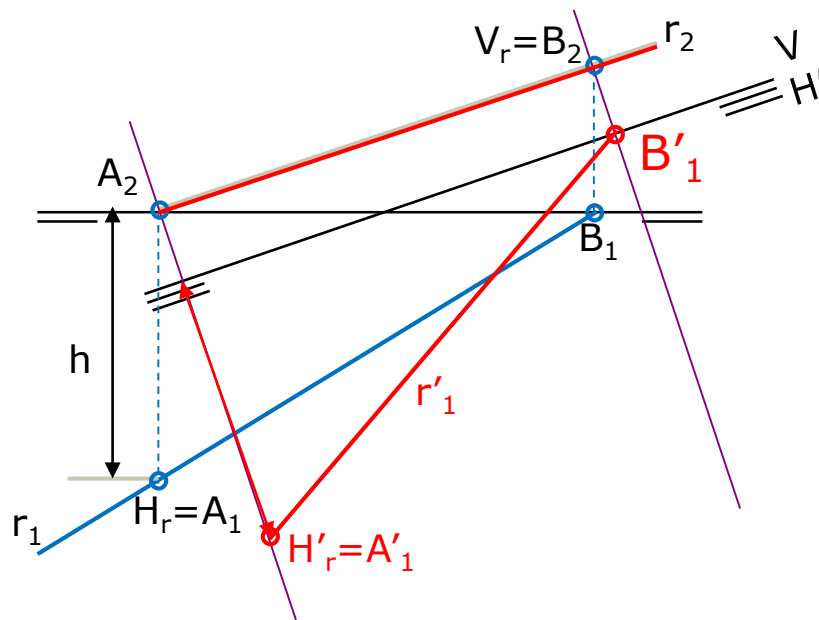

□ Transform a line in a frontal line, by means of change of the vertical plane ($V \rightarrow V'$), such that the new R.L. is // to r_1

Change of planes of a line

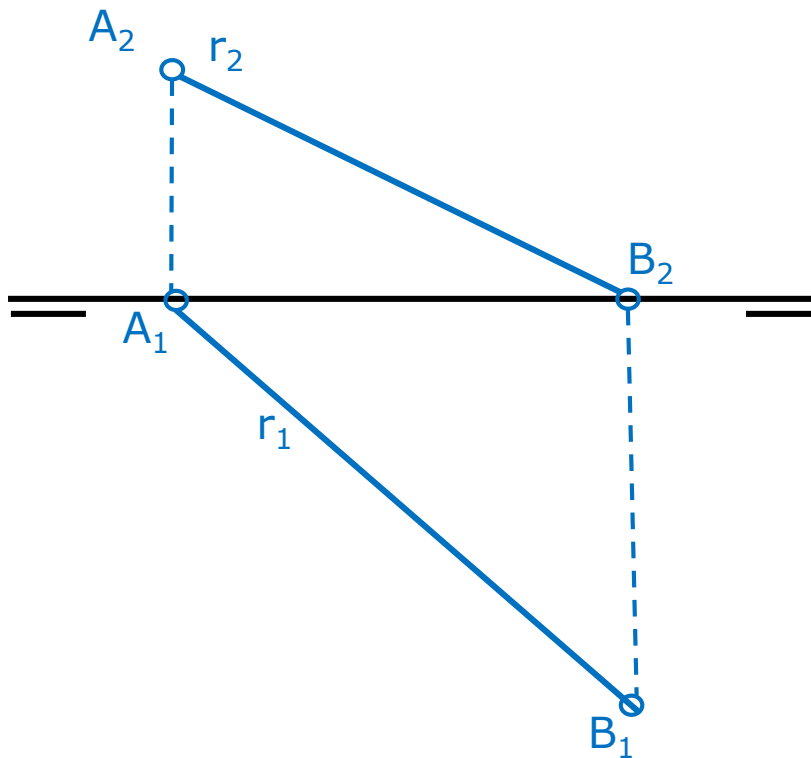

Transform a line in a vertical or tip line
through 2 consecutive changes of planes

Change of planes of a line

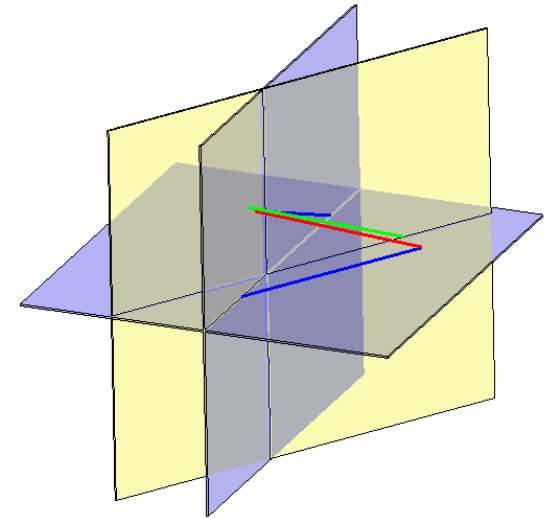
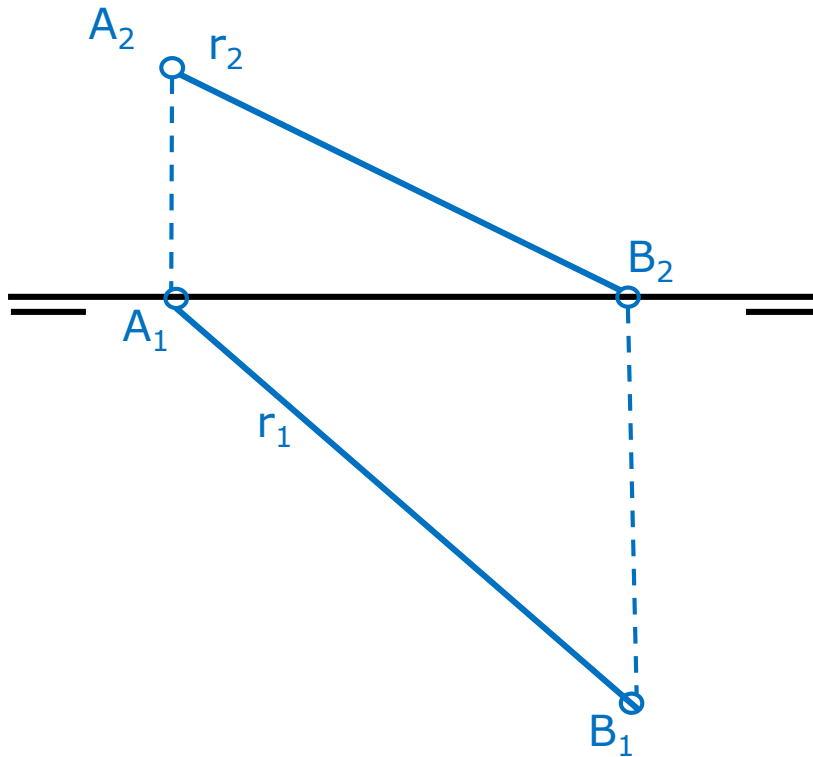

Transform a line in a vertical or tip line through 2 consecutive changes of planes

Change of planes of a line

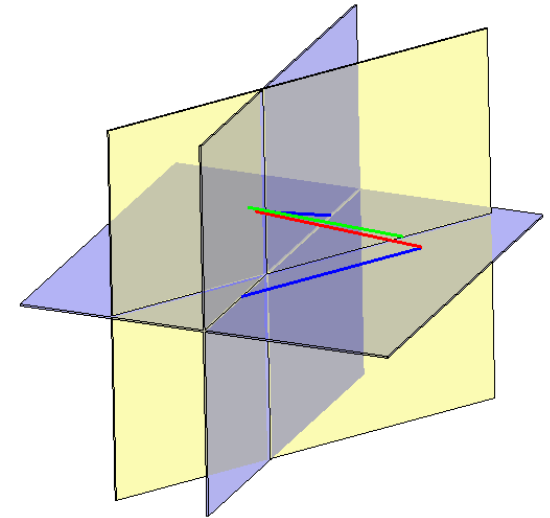
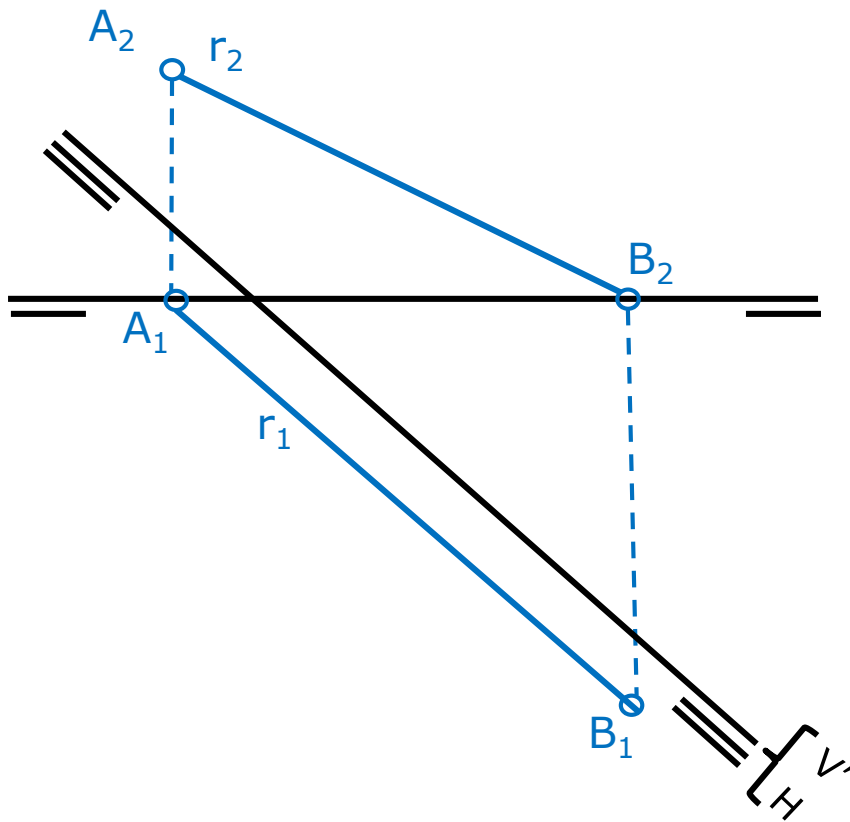

Transform a line in a vertical or tip line through 2 consecutive changes of planes

Change of planes of a line

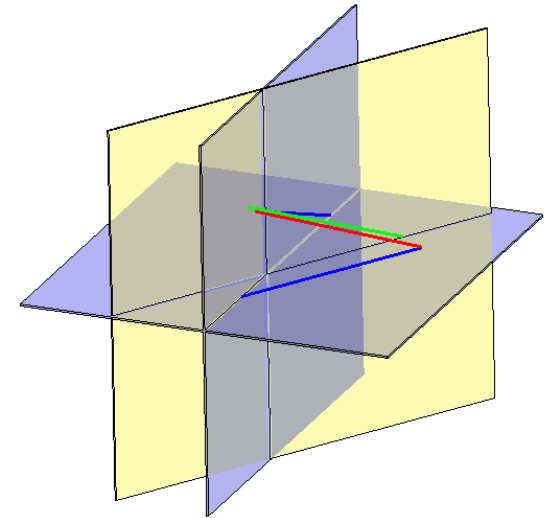
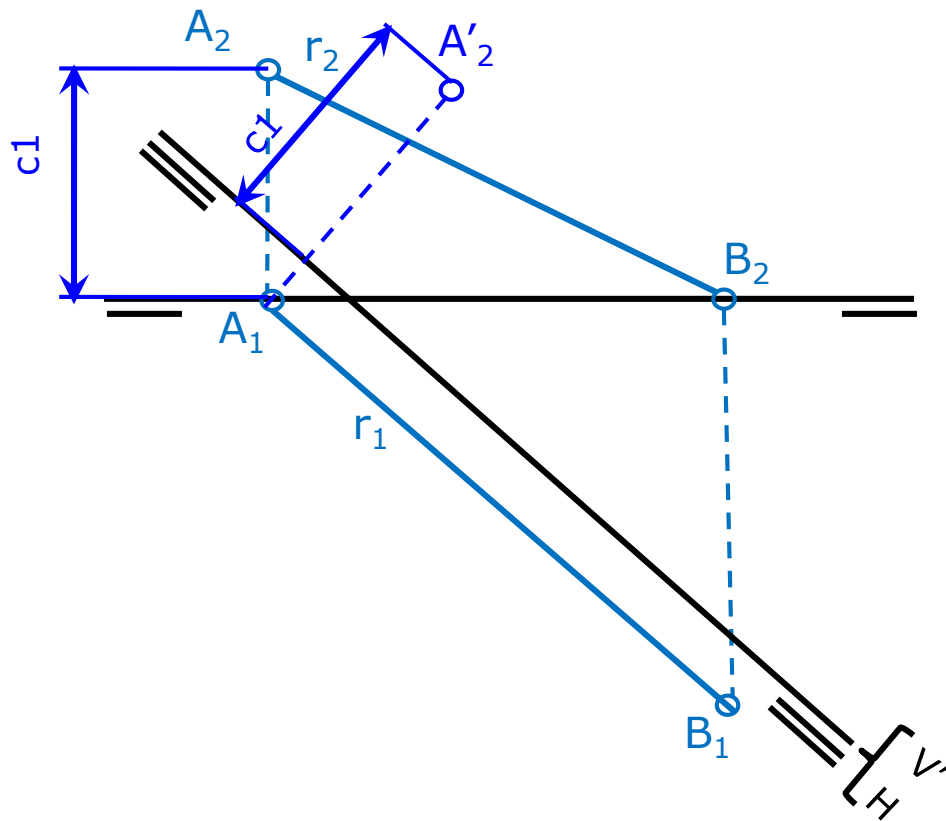

Transform a line in a vertical or tip line through 2 consecutive changes of planes

Change of planes of a line

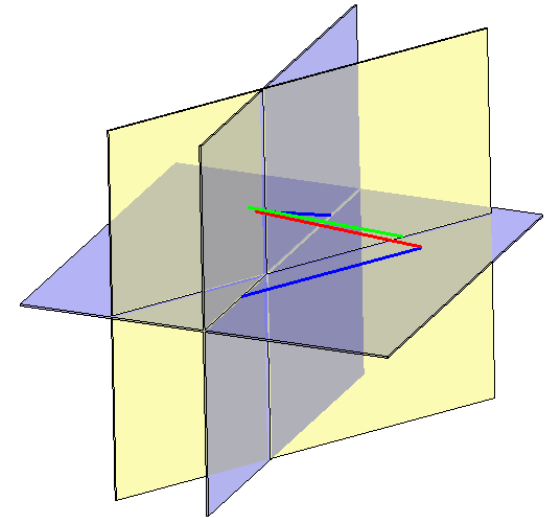
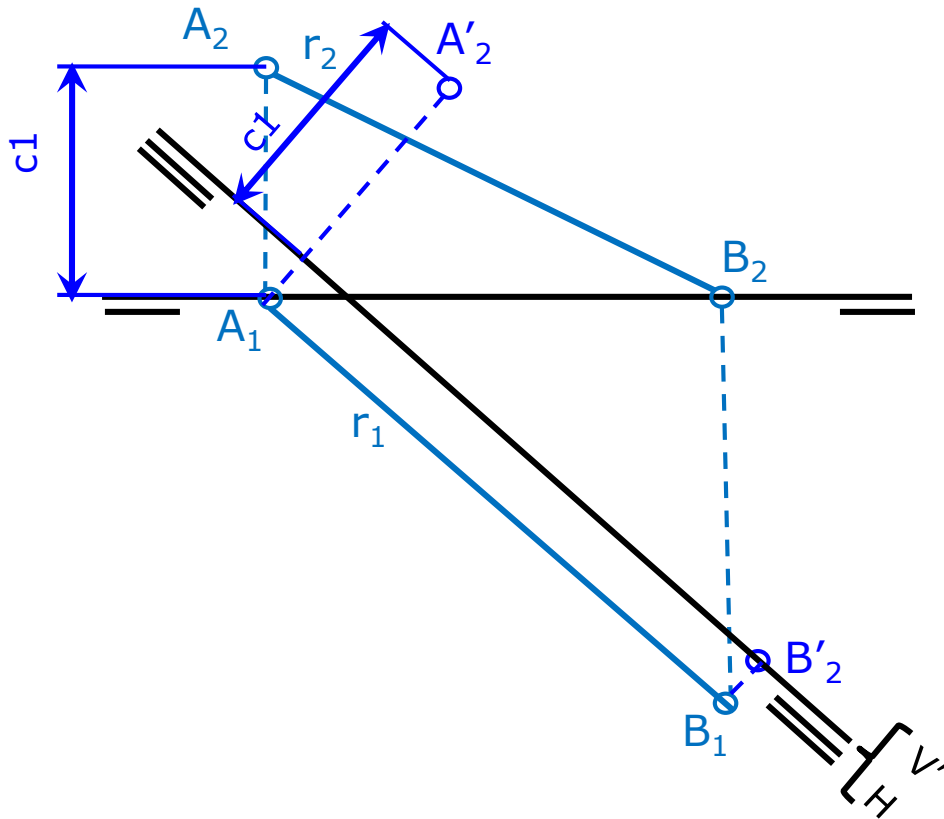

Transform a line in a vertical or tip line through 2 consecutive changes of planes

Change of planes of a line

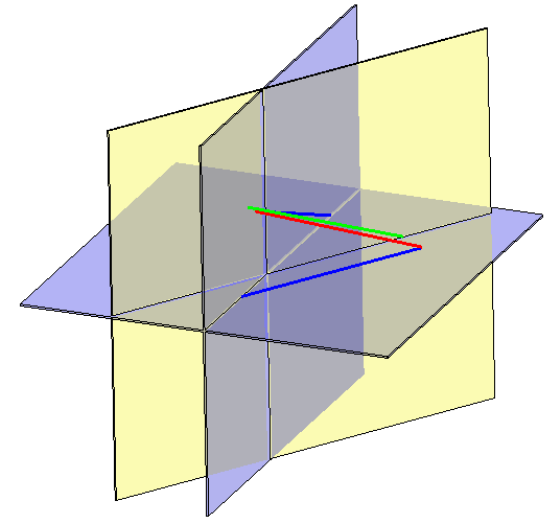
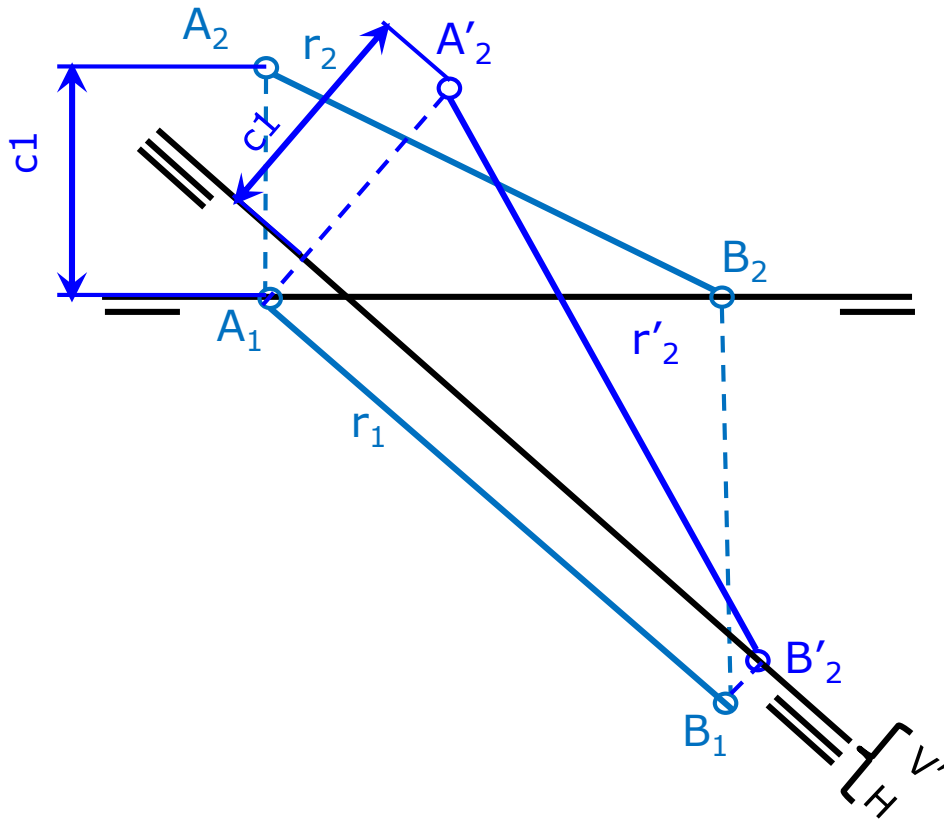

Transform a line in a vertical or tip line through 2 consecutive changes of planes

Change of planes of a line

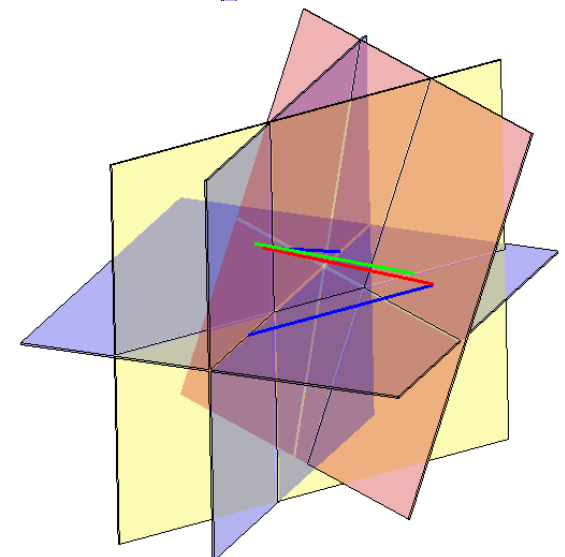
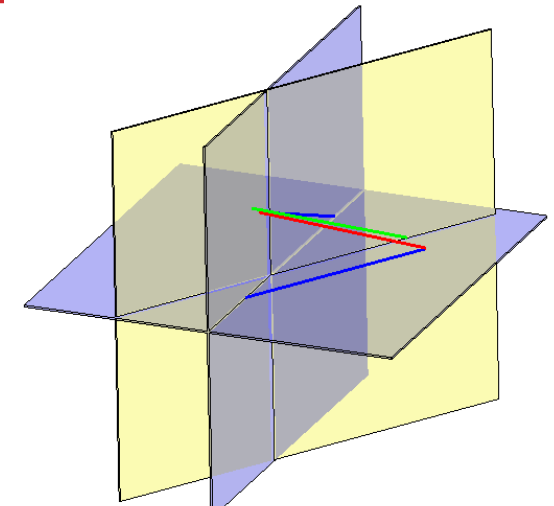
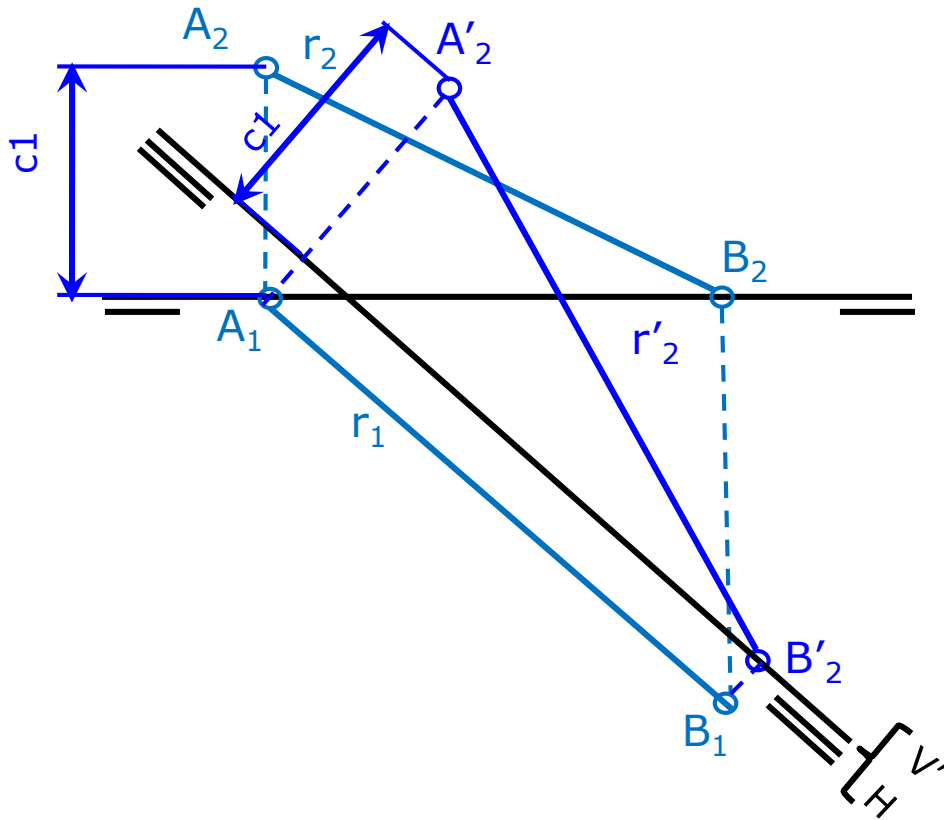

Transform a line in a vertical or tip line through 2 consecutive changes of planes

Change of planes of a line

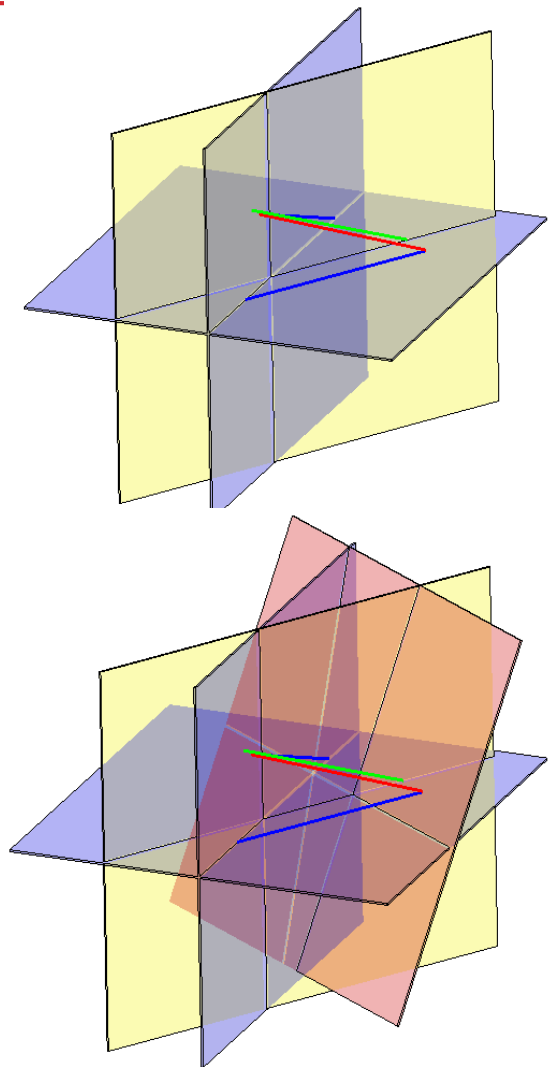
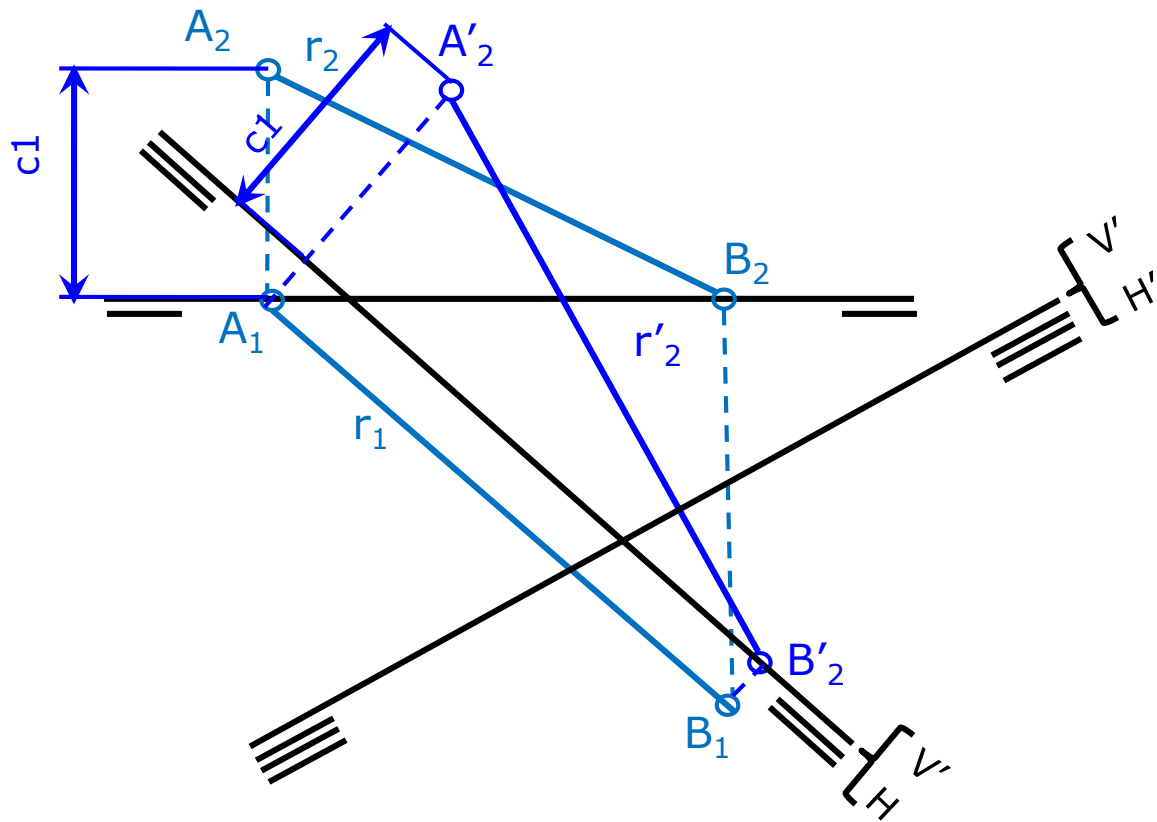

Transform a line in a vertical or tip line through 2 consecutive changes of planes

Change of planes of a line

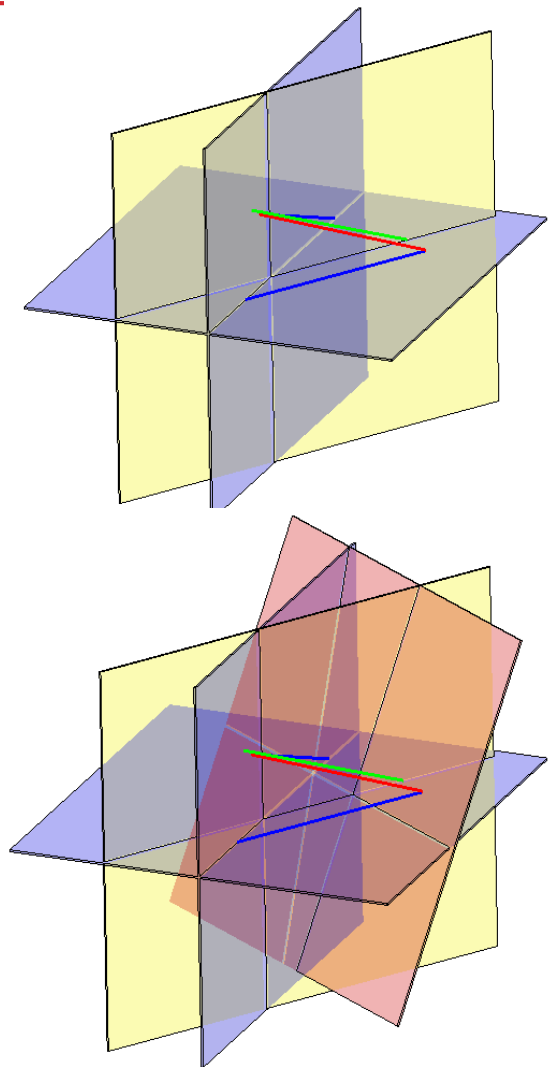
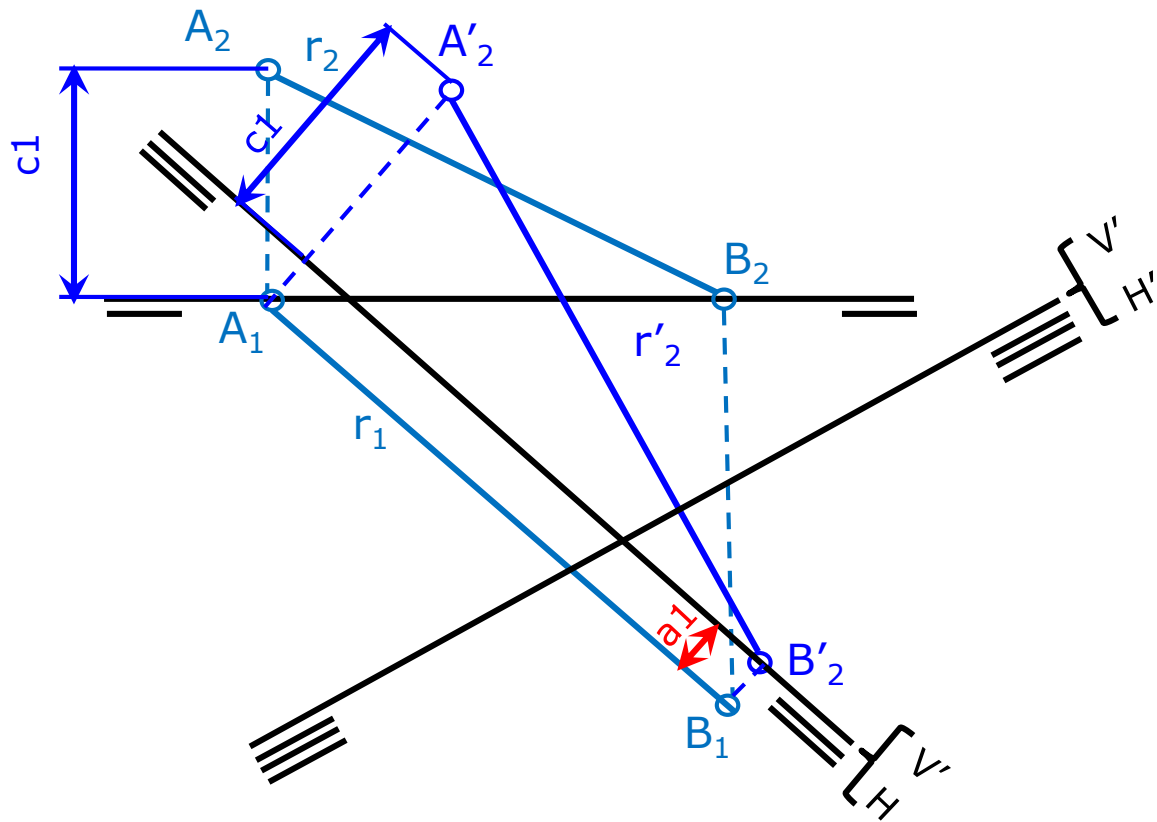

Transform a line in a vertical or tip line through 2 consecutive changes of planes

Change of planes of a line

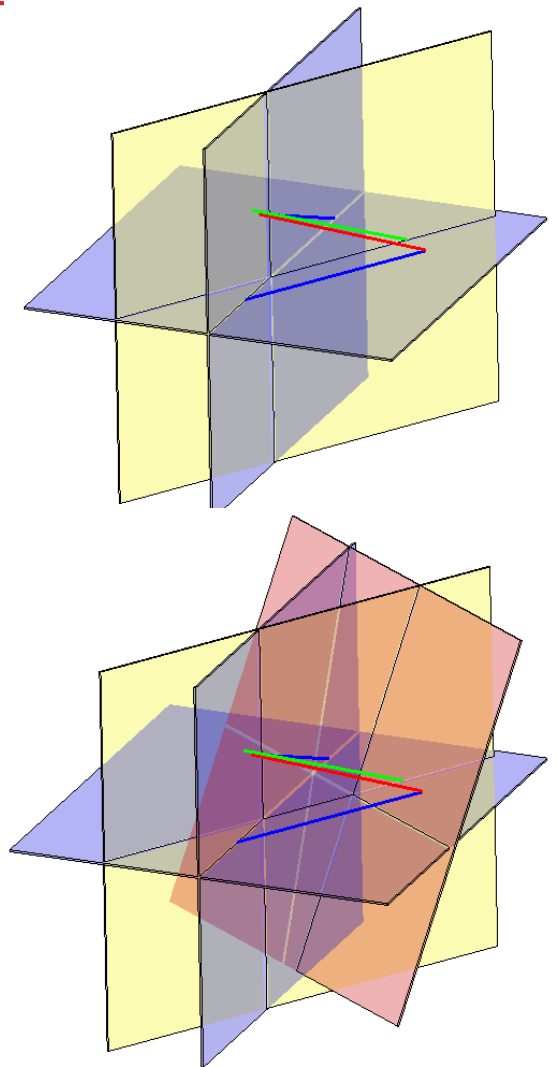
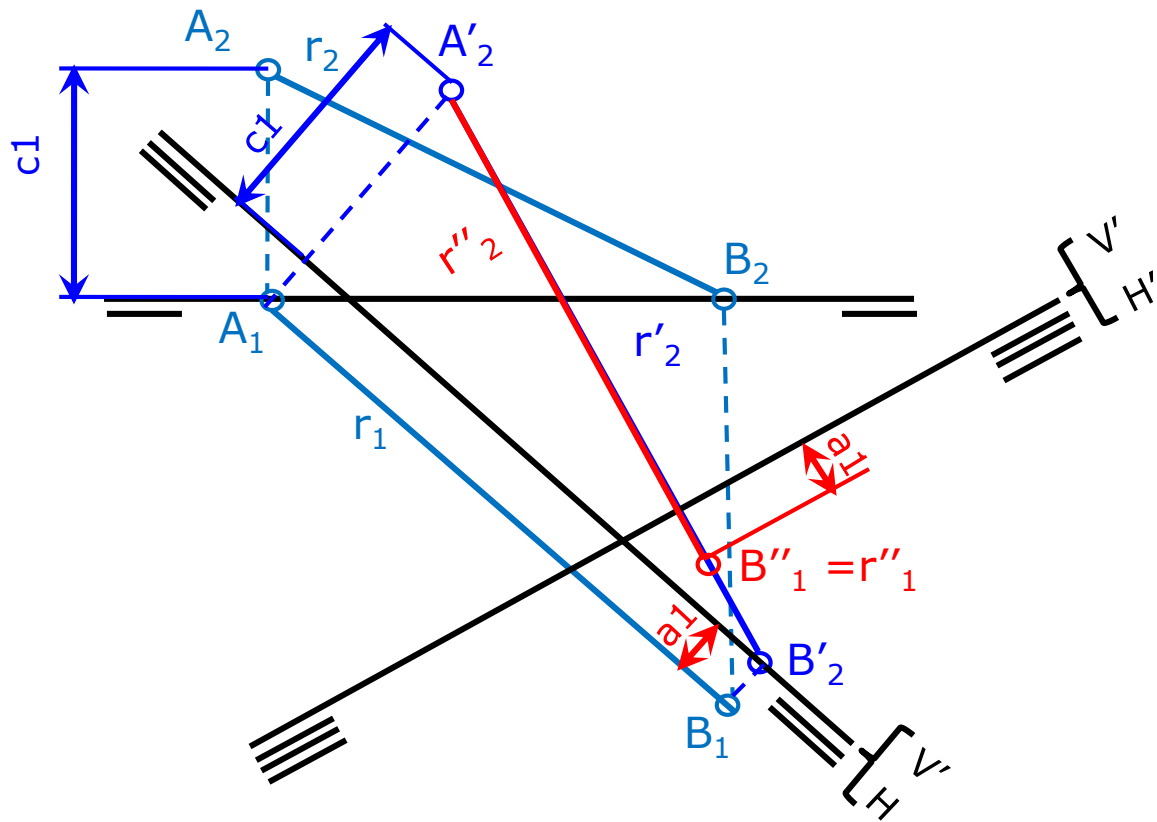

Transform a line in a vertical or tip line through 2 consecutive changes of planes

Change of planes of a plane

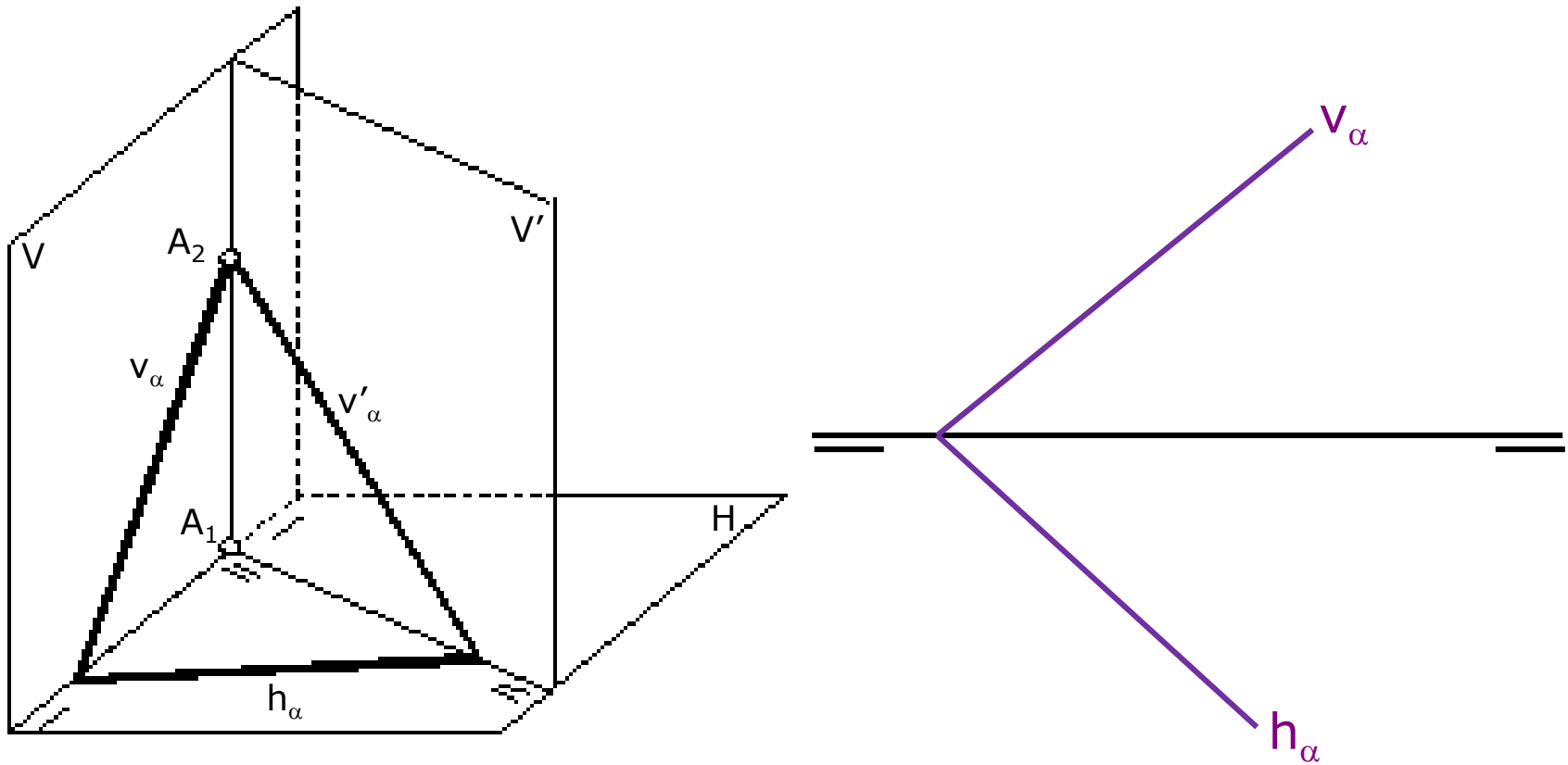

Change of planes of a plane

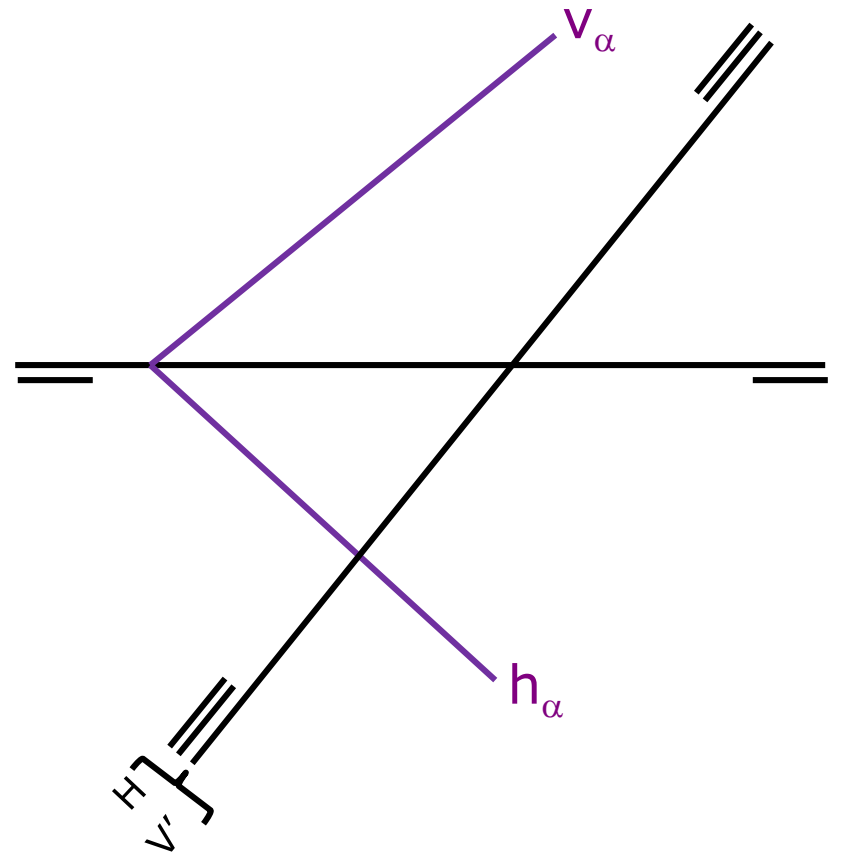
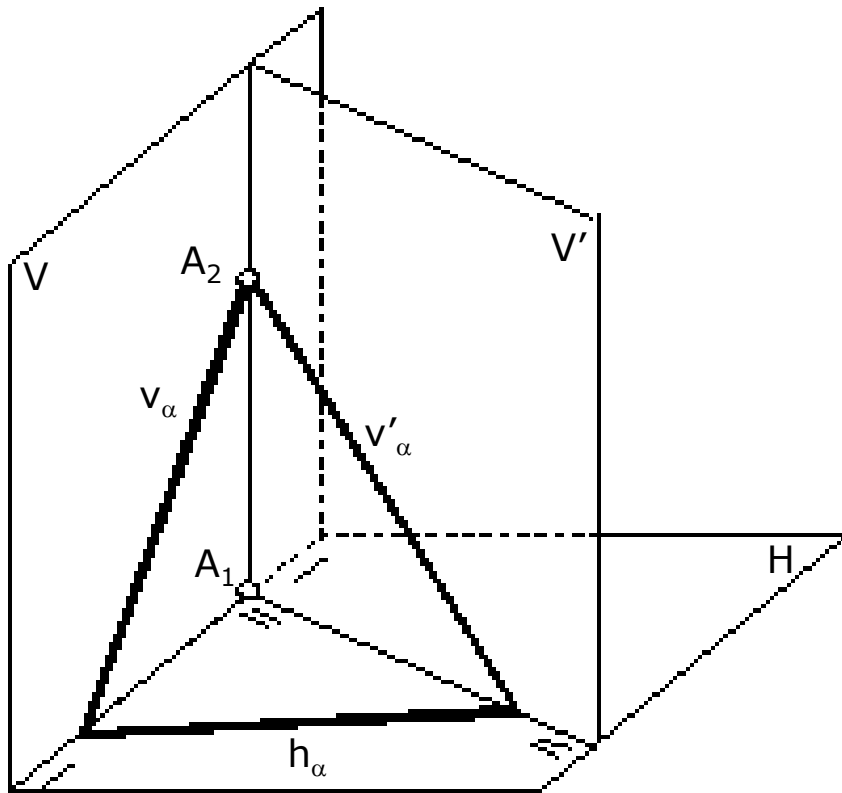

Change of planes of a plane

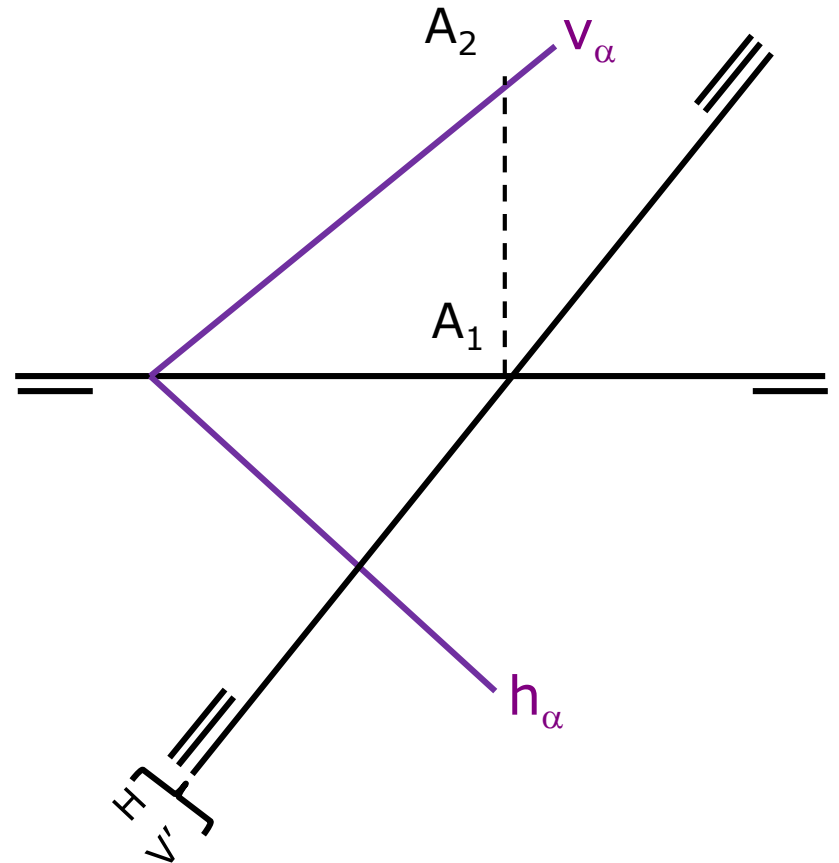
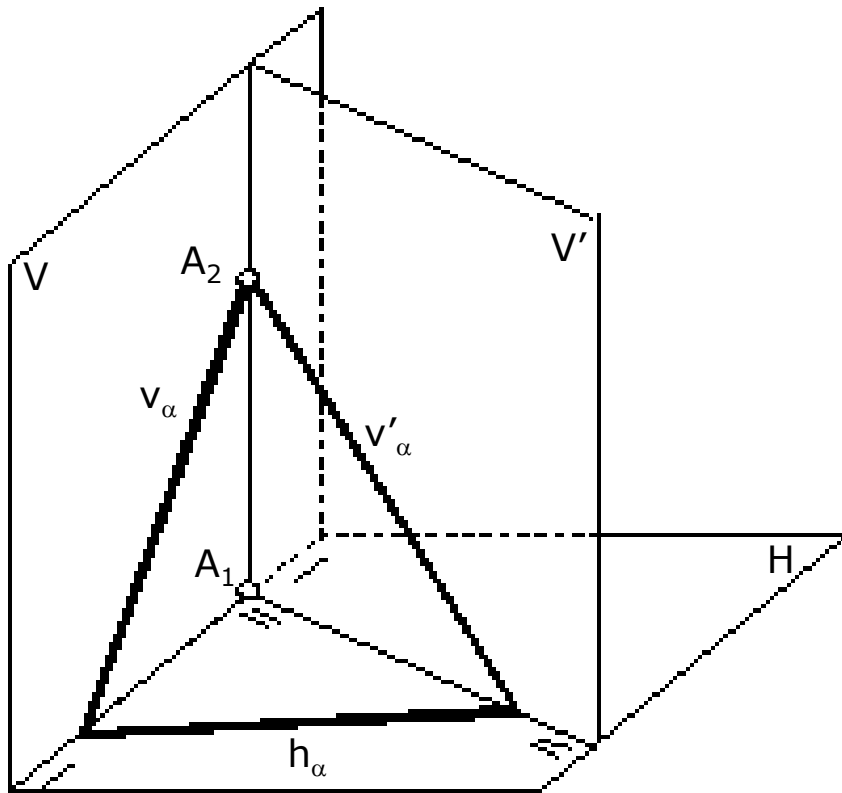

Change of planes of a plane

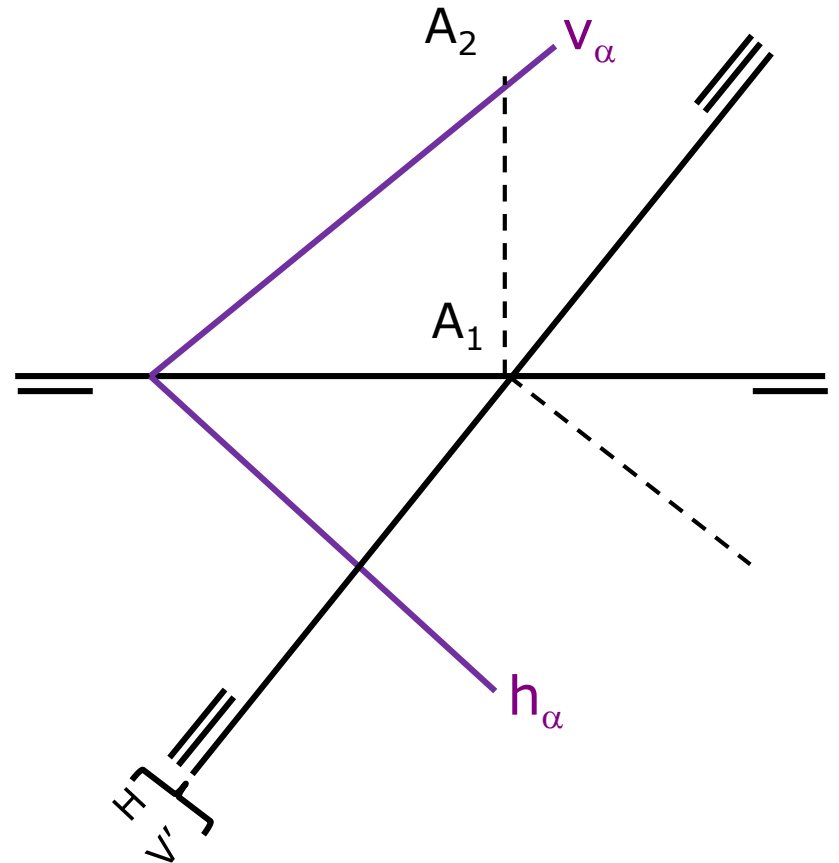
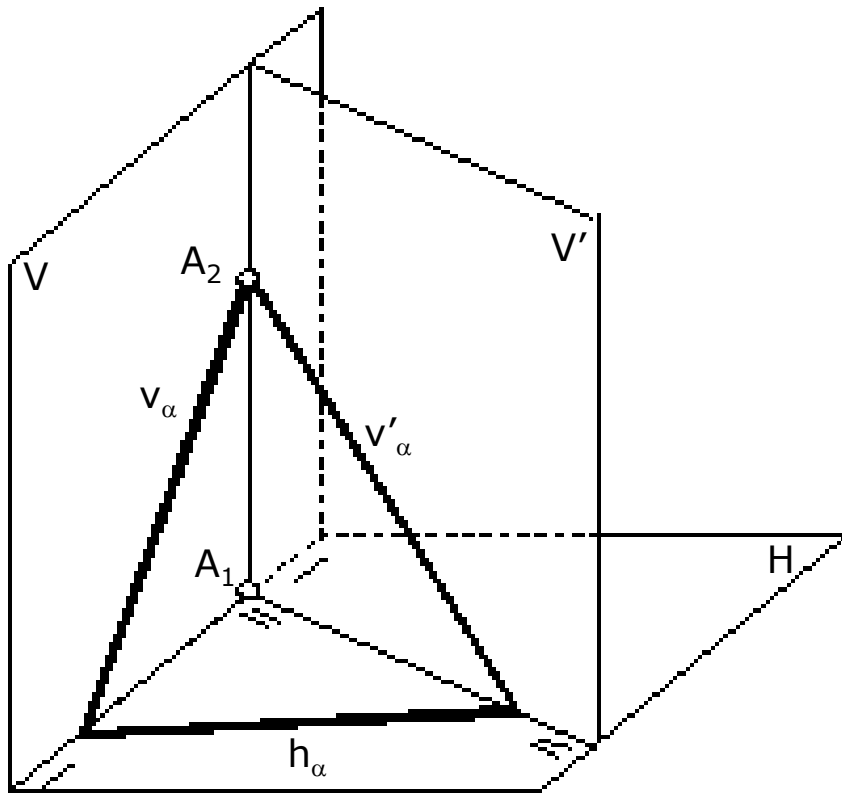

Change of planes of a plane

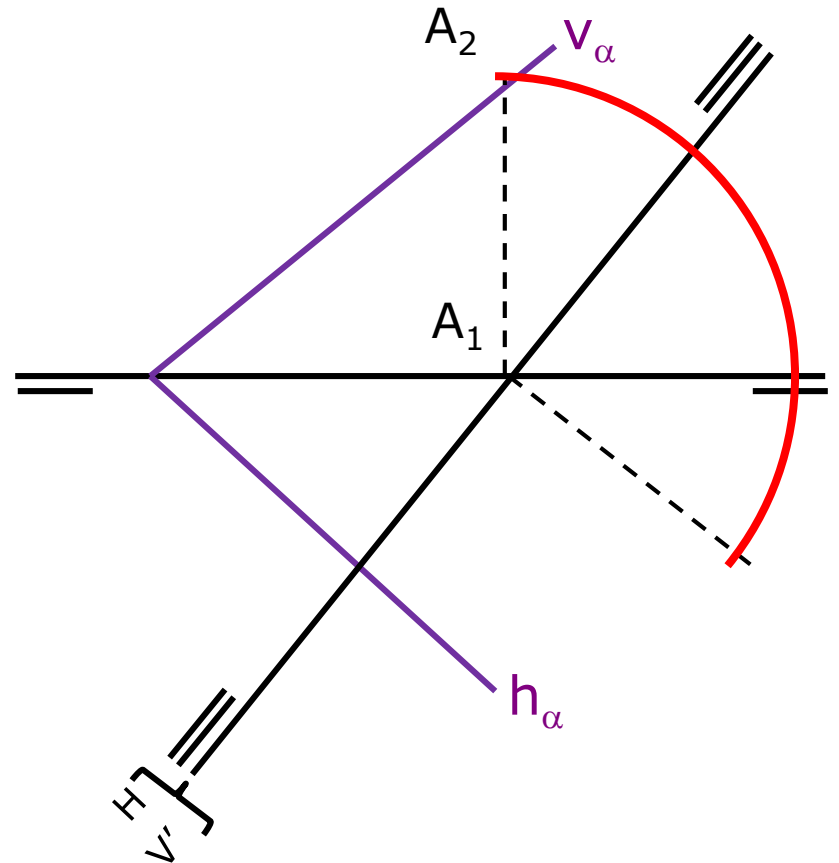
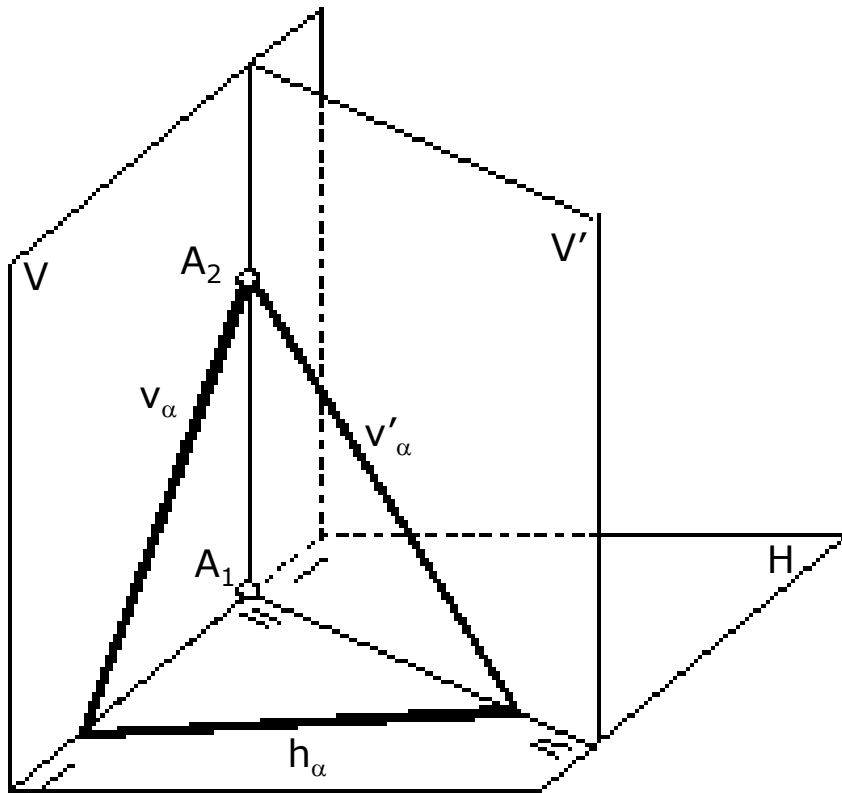

Change of planes of a plane

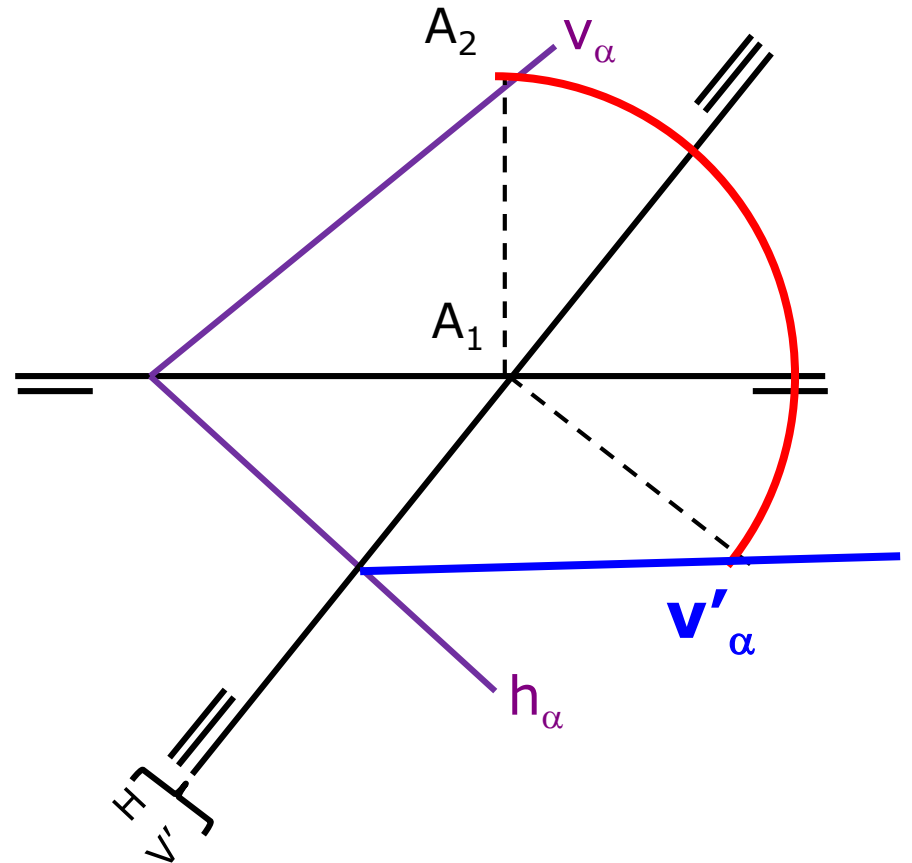
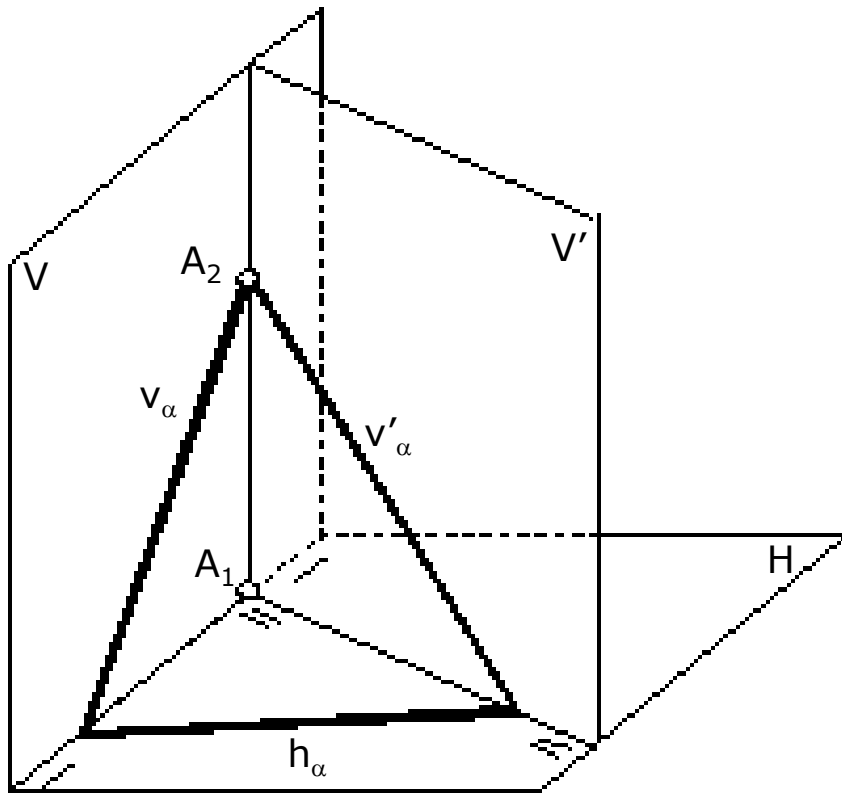

Examples

□ Auxiliary views

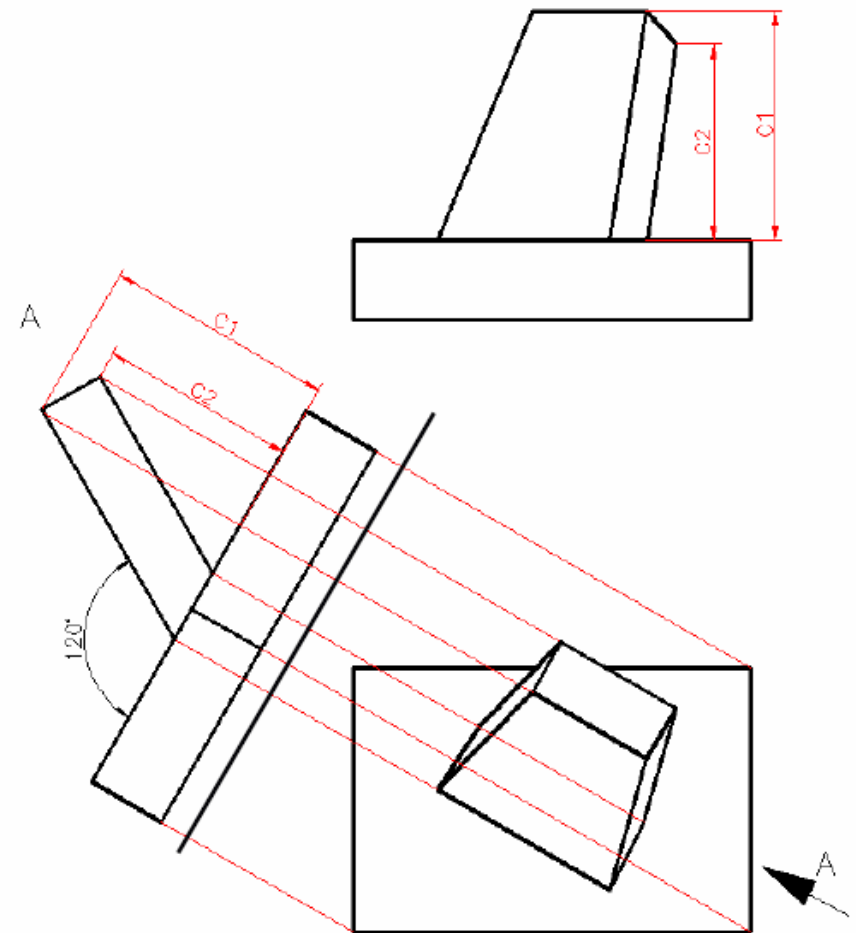
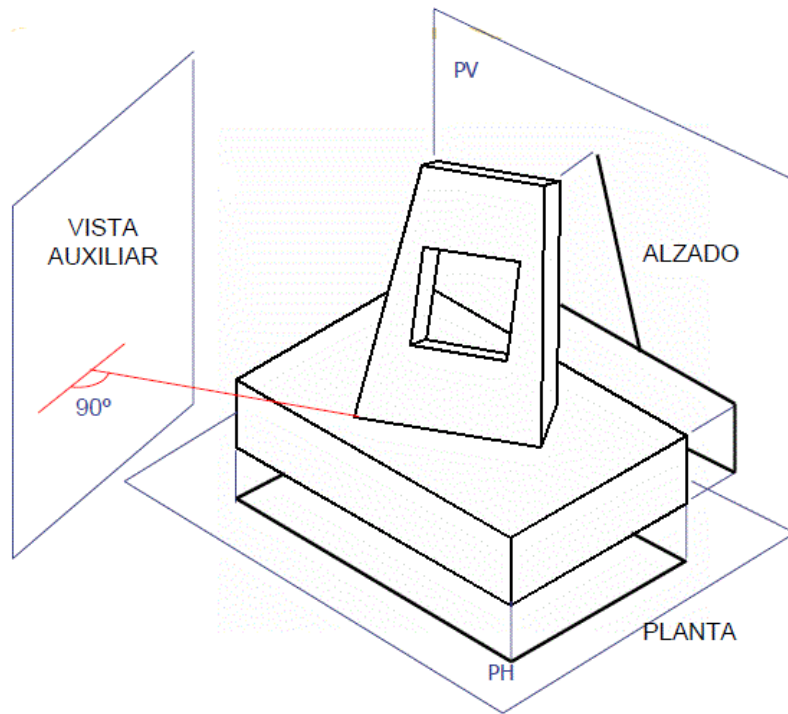

Examples

Draw by means of change of plans, an equilateral triangle of 40 mm side included in plane α . Side AB is included in a frontal line of the plane and the point B has less height than point A.
 DATA: h_α forms -30° with the R.L. v_α forms 140° with the R.L. Point A is located 100mm of the intersection of the traces (measured over the horizontal and has a height of 40mm.

horizontal) y tiene una cota de 40mm

1. Situar el plano y los puntos A y B
2. Realizar un cambio de plano para convertir el del enunciado en plano proyectante vertical
3. Aplicar el cambio de plano a A y B
4. Aplicar un nuevo cambio de plano para convertir el plano en horizontal. Aplicar dicho cambio a A y a B
5. Al ser el plano horizontal, puede construirse la proyección horizontal del triángulo en verdadera magnitud.
6. Deshacer los cambios de plano de C
7. Construir las proyecciones originales del triángulo

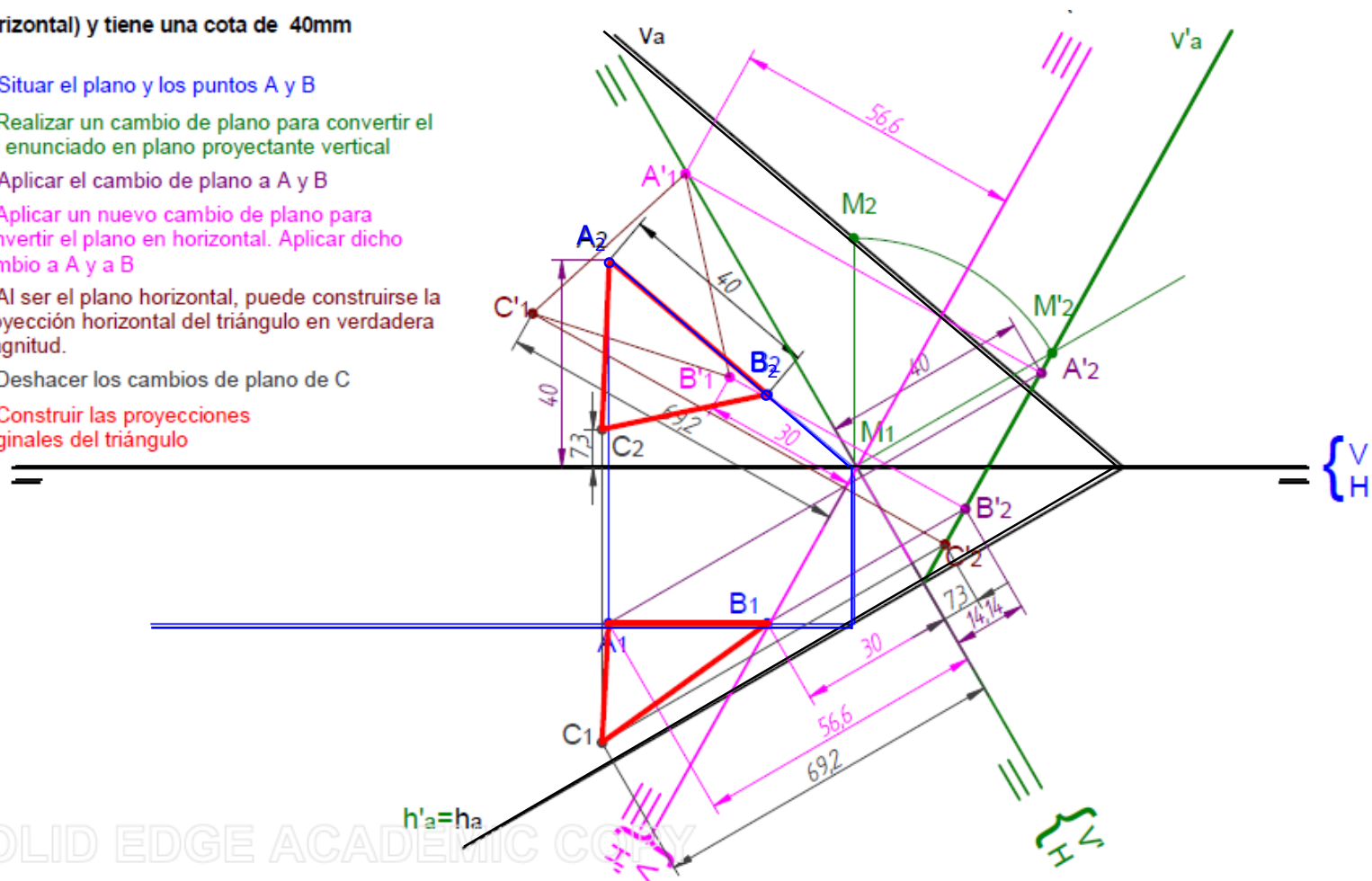

Fold line method: Point

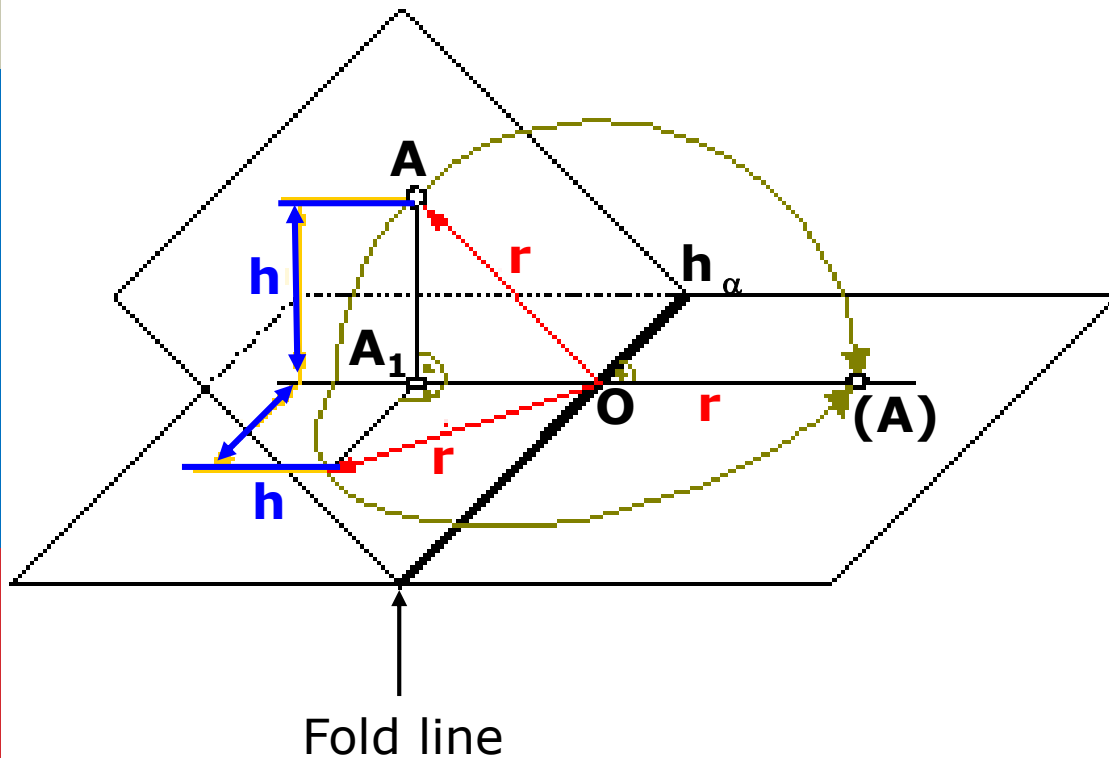

Fold line method: Point

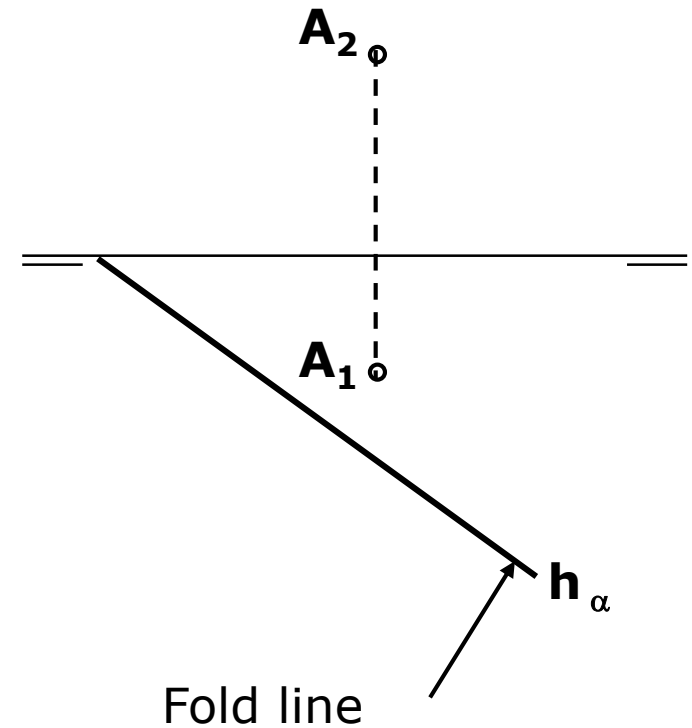
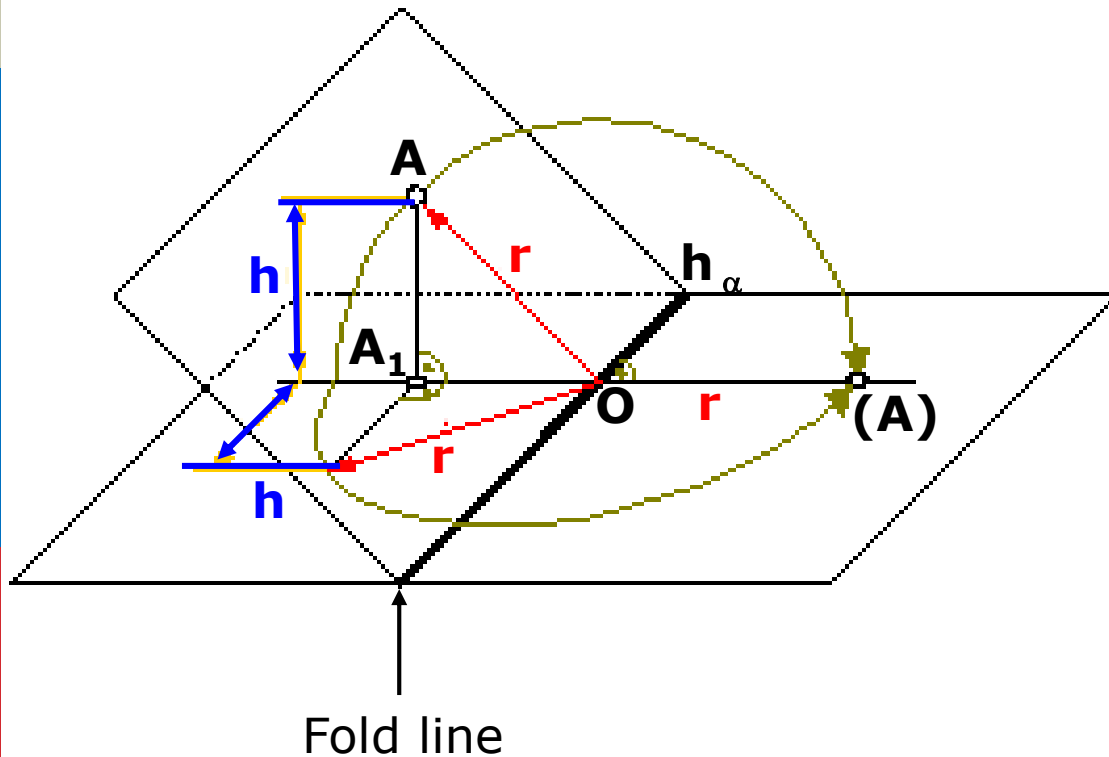

Fold line method: Point

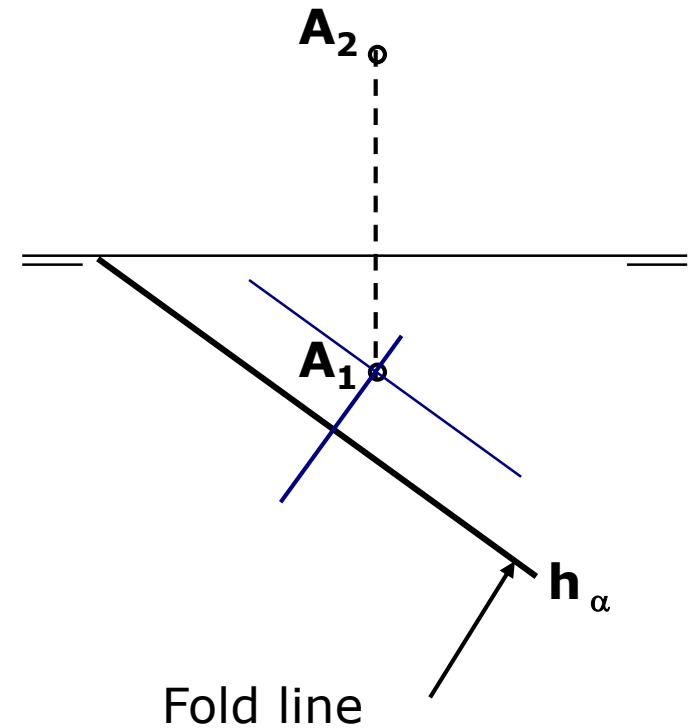
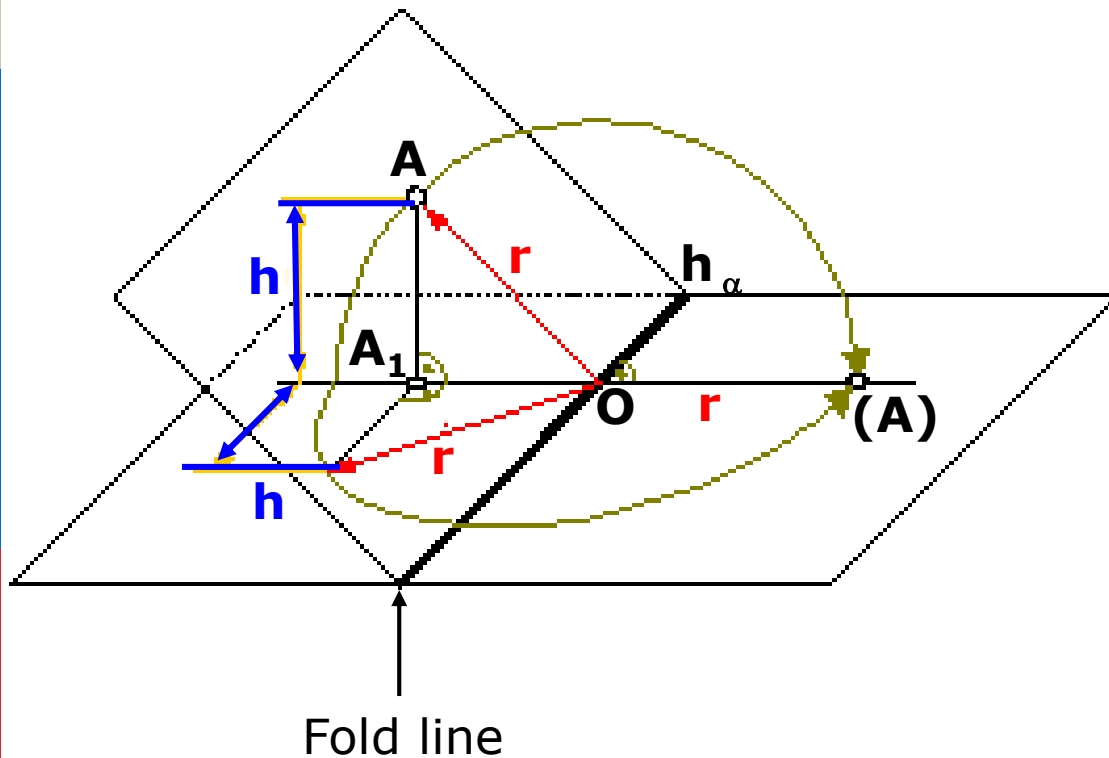

Fold line method: Point

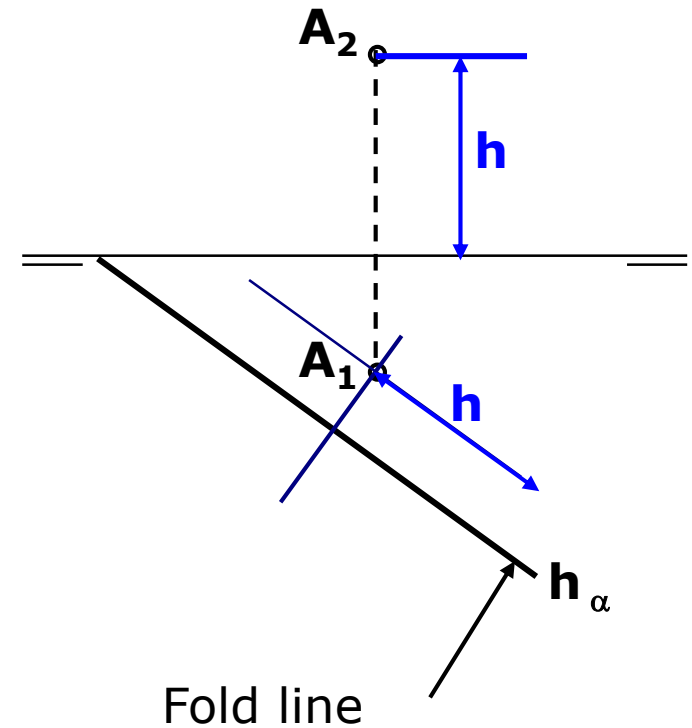
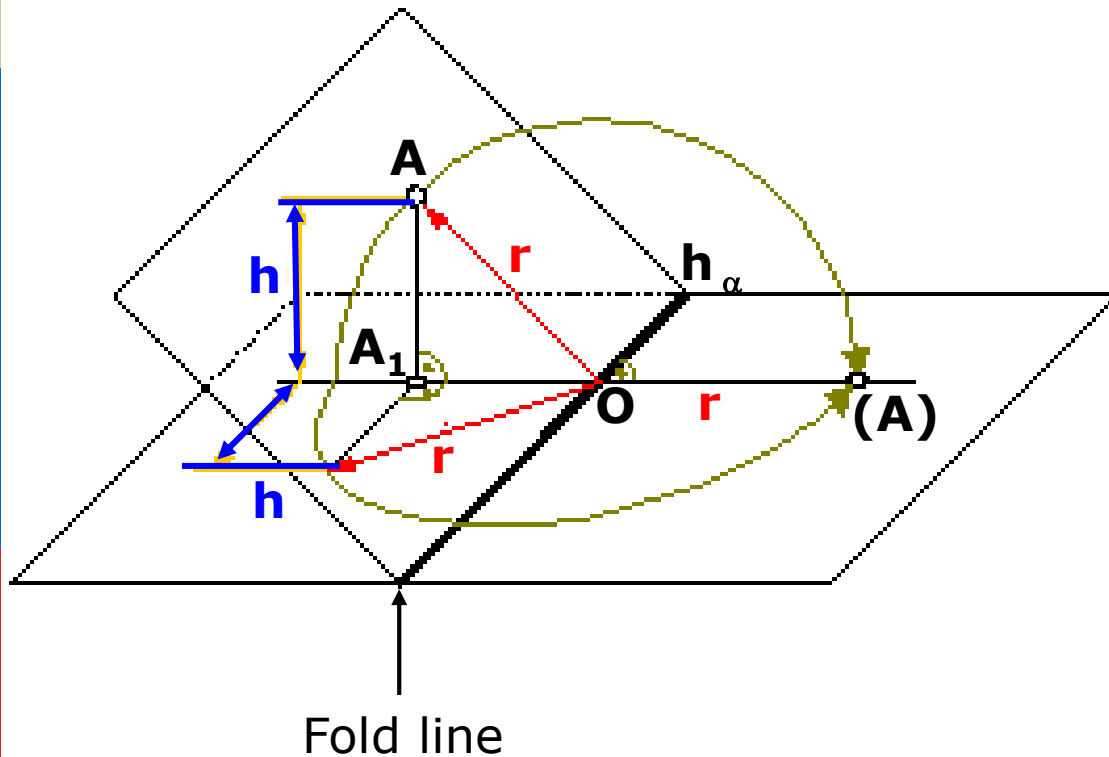

Fold line method: Point

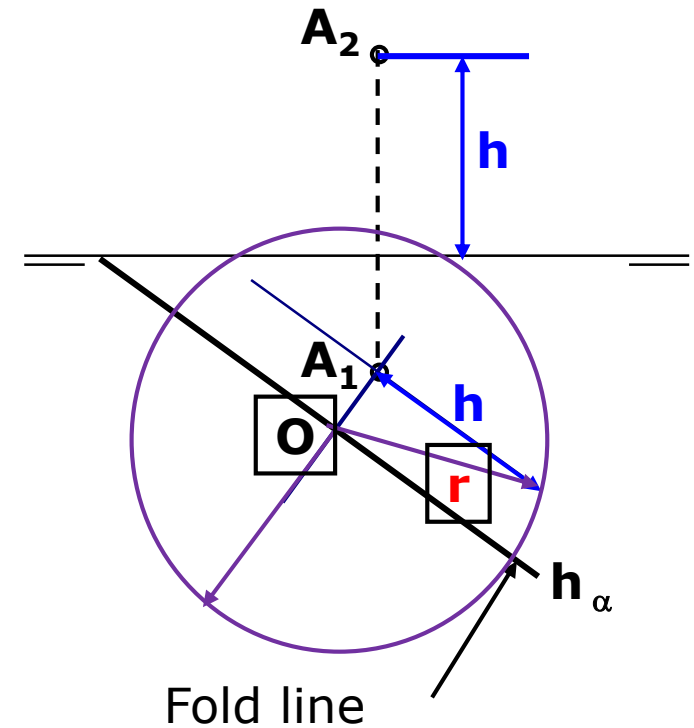
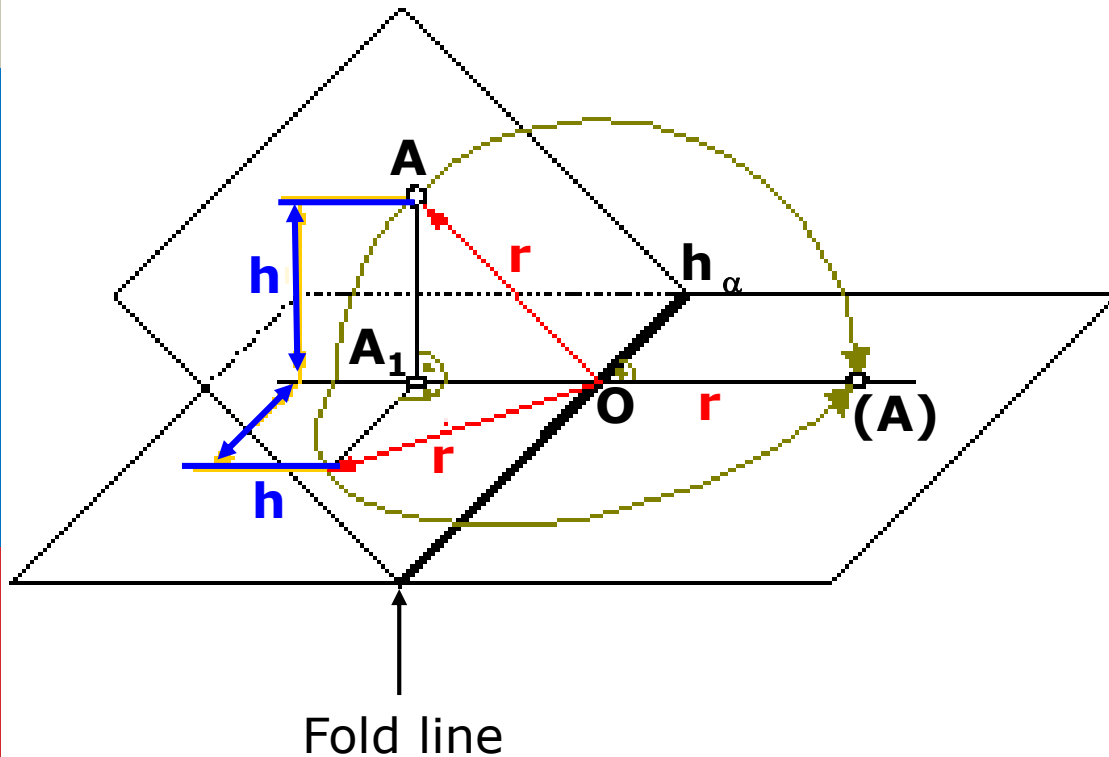

Fold line method: Point

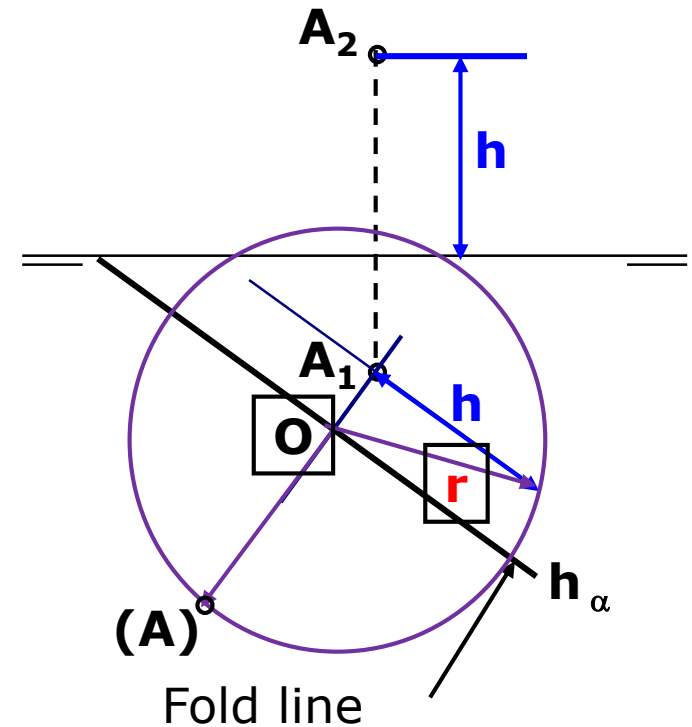
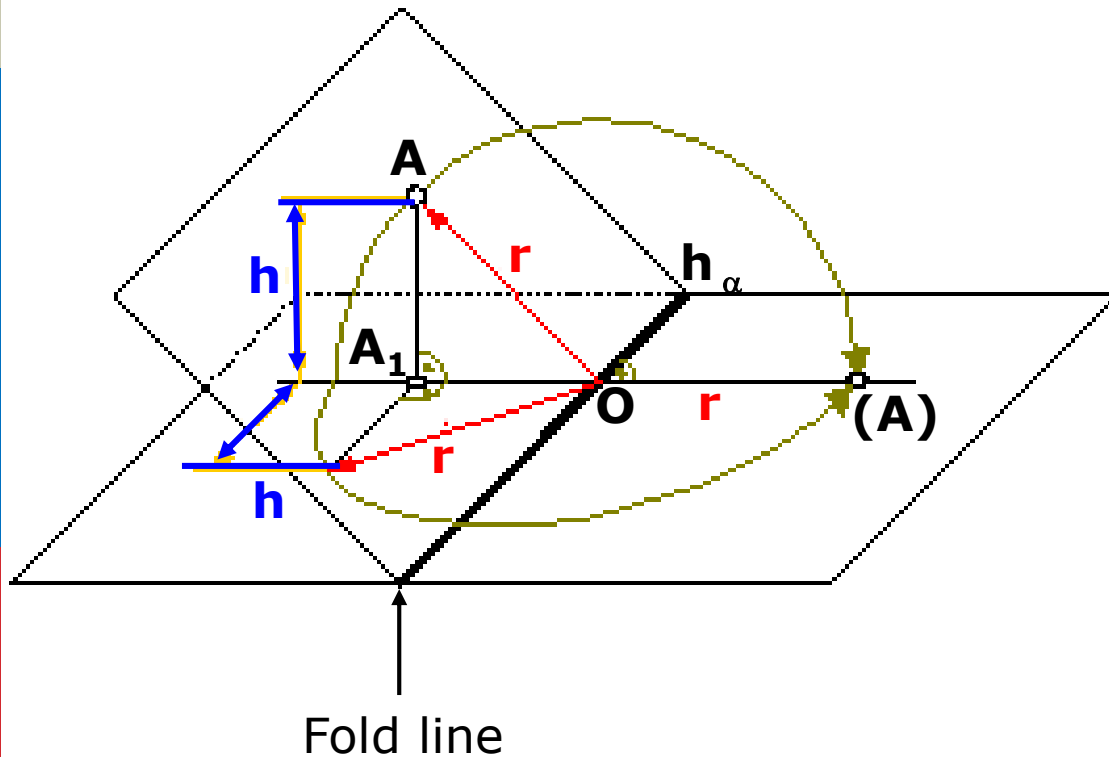

Fold line of a plane I

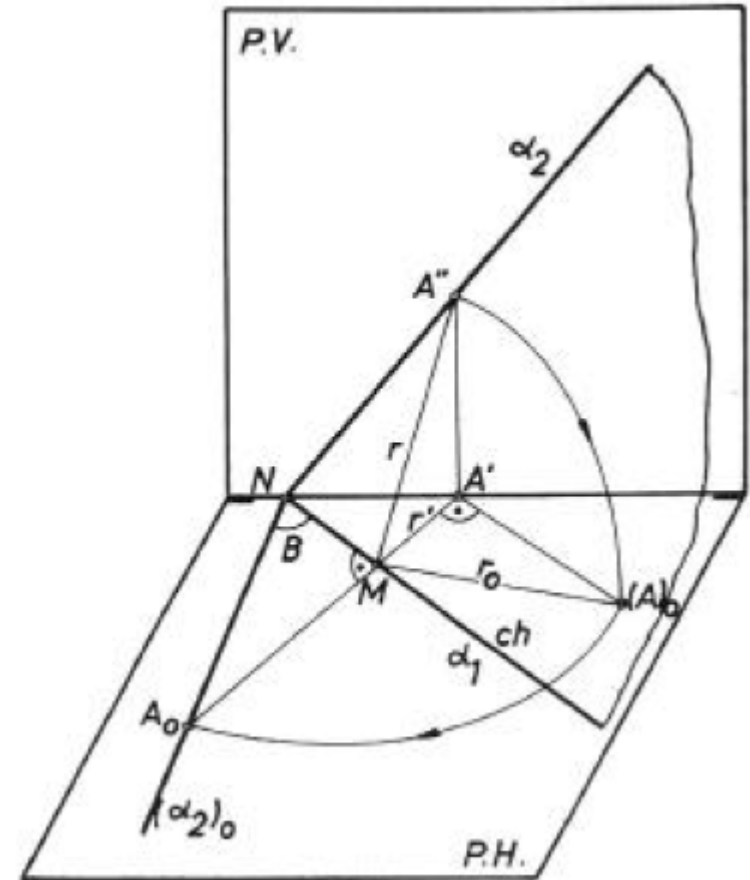
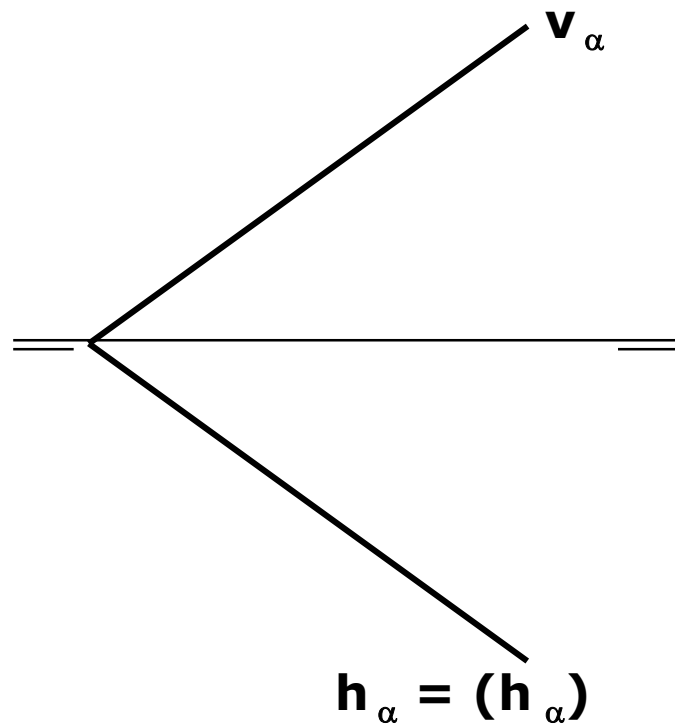

Fold line of a plane I

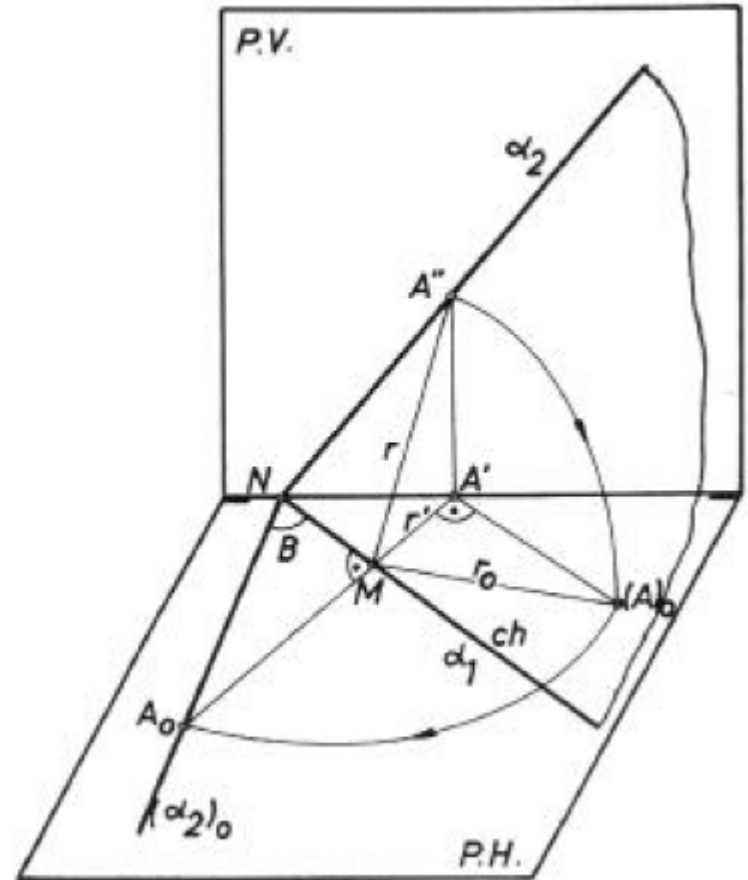
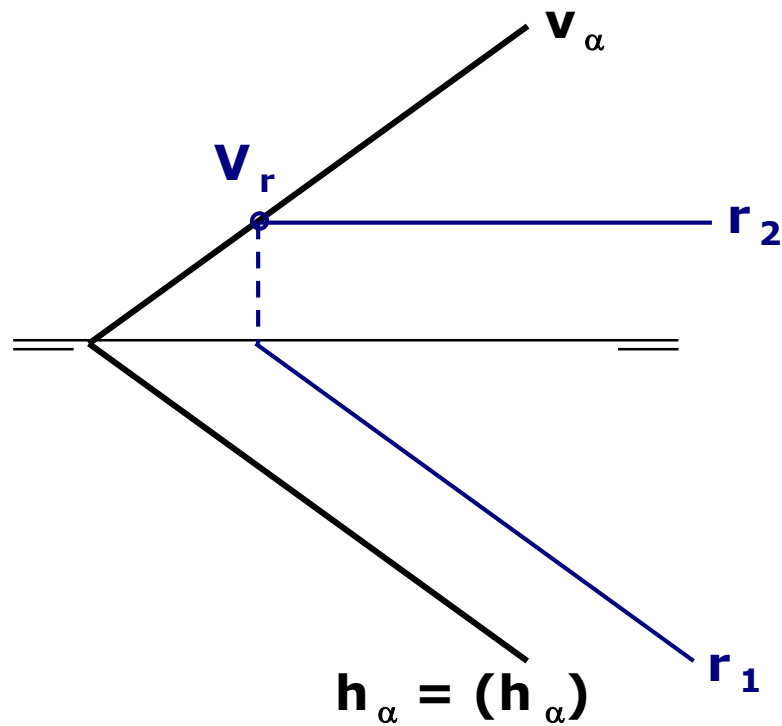

Fold line of a plane I

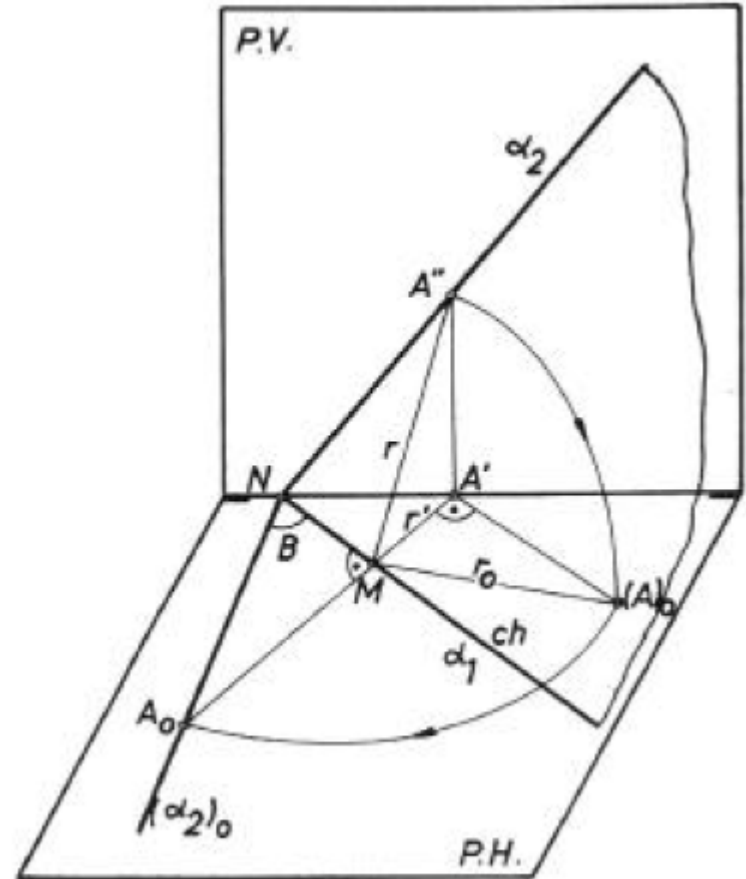
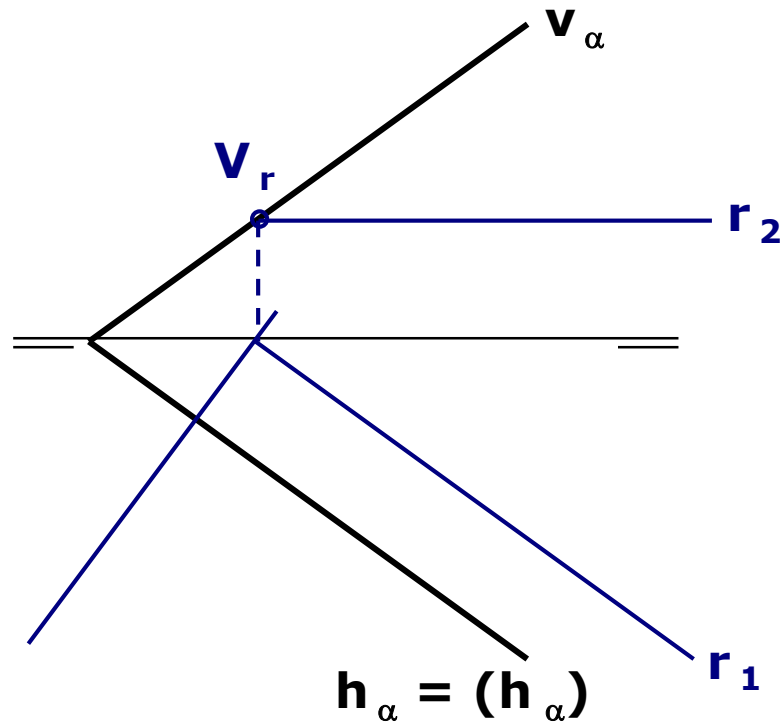

Fold line of a plane I

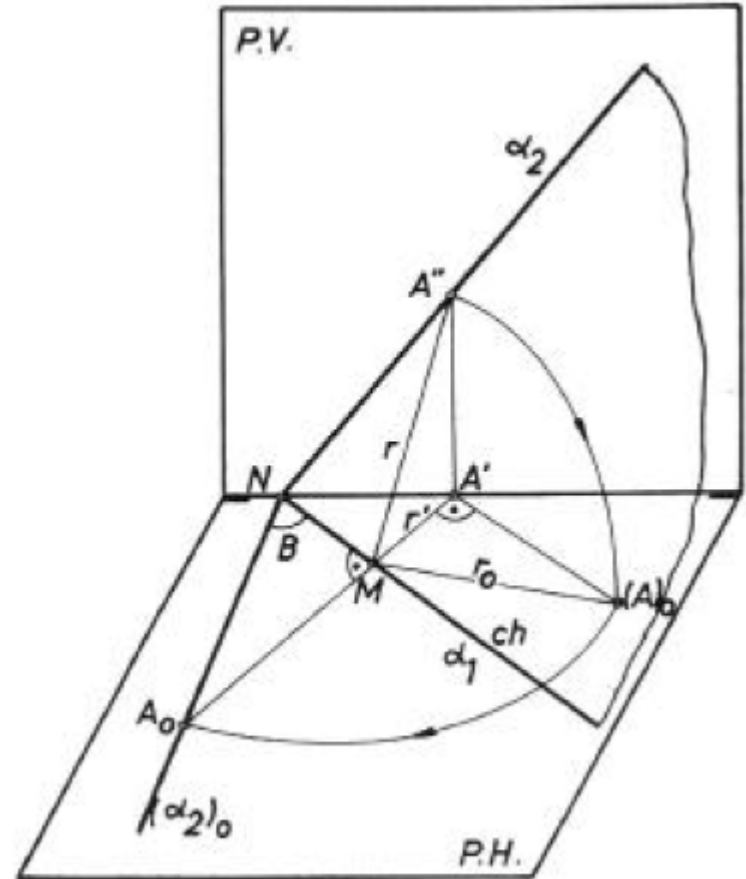
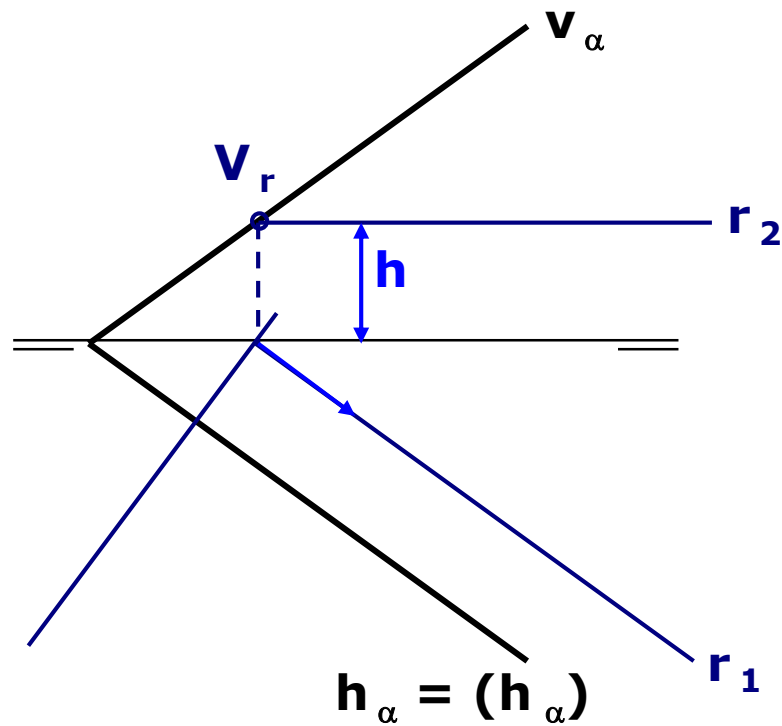

Fold line of a plane I

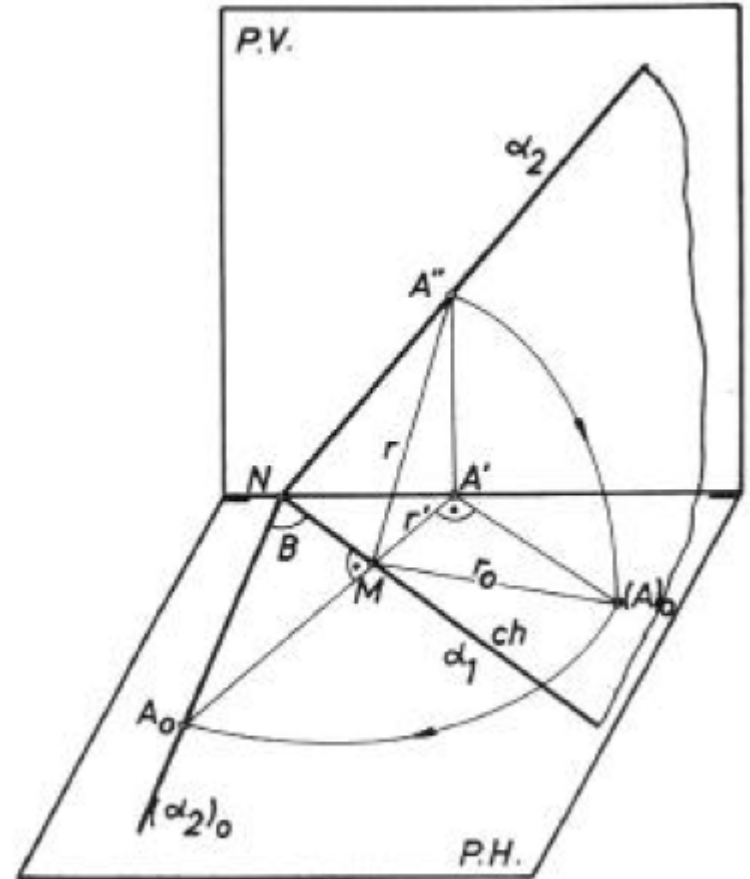
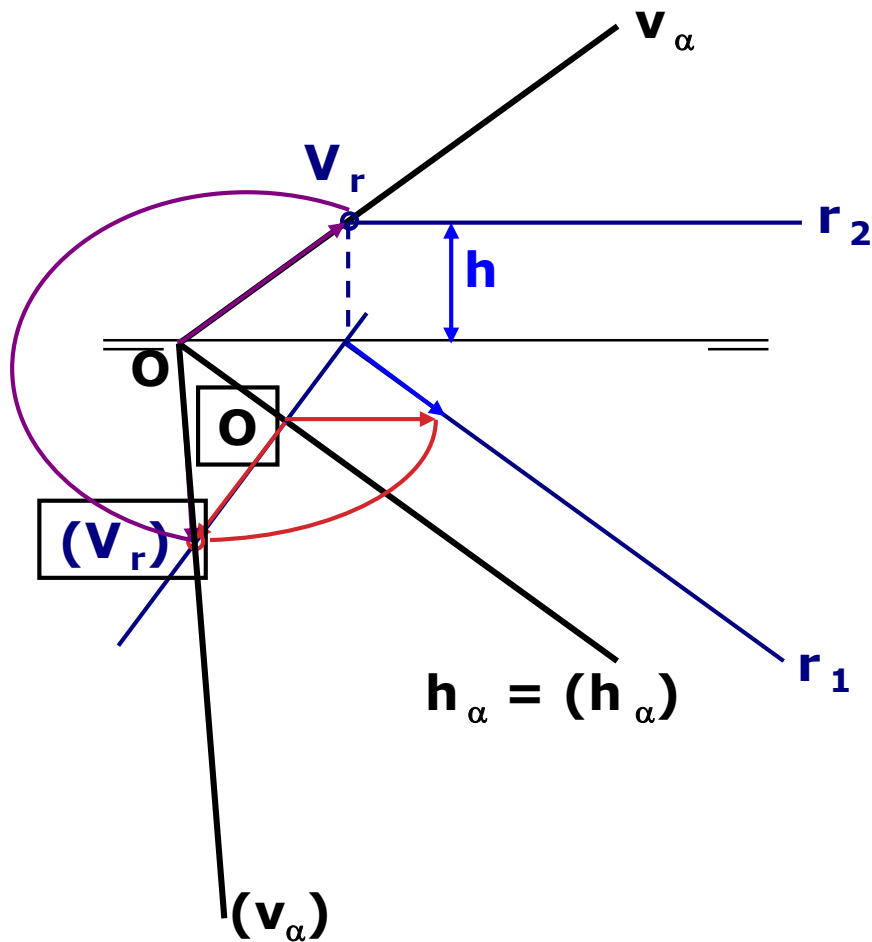

Fold line of a plane II

- Planes parallel to the R.L.

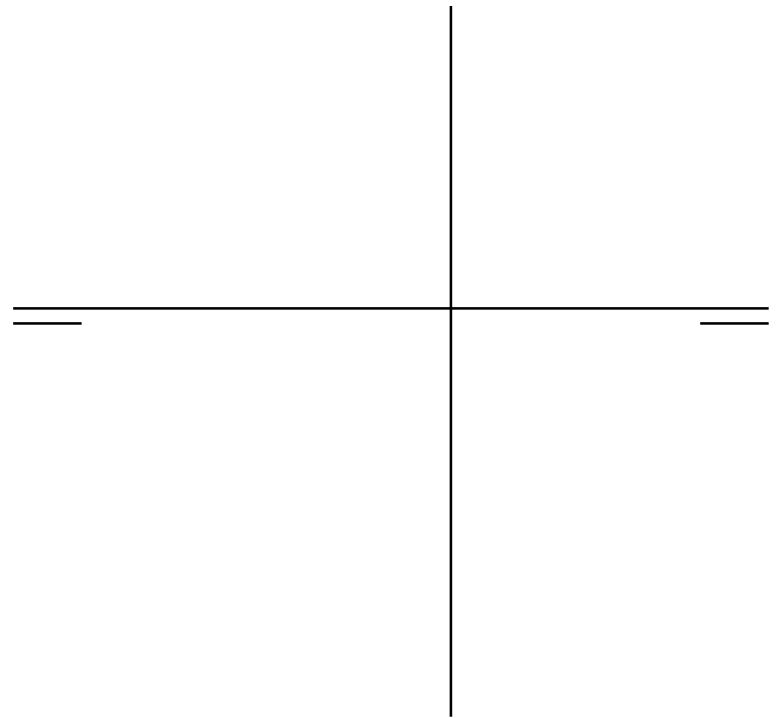
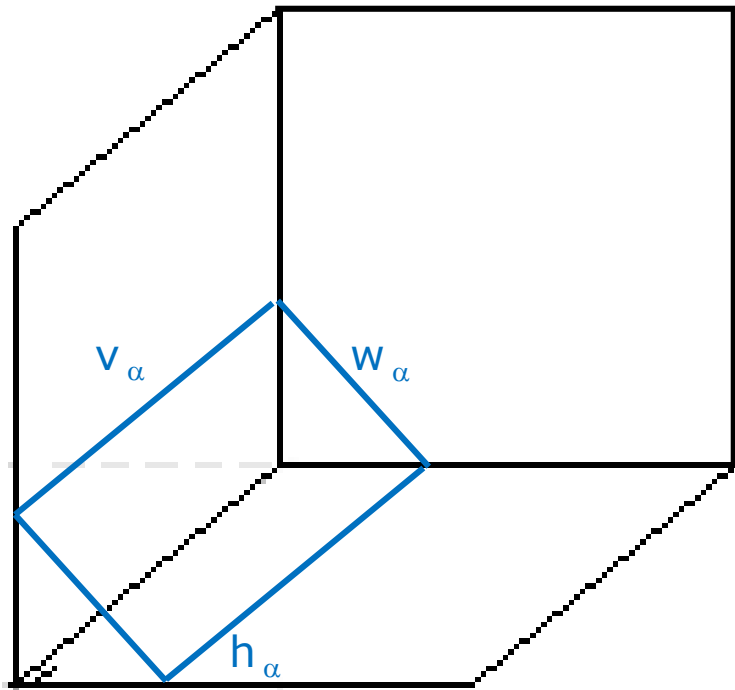

Fold line of a plane II

- Planes parallel to the R.L.

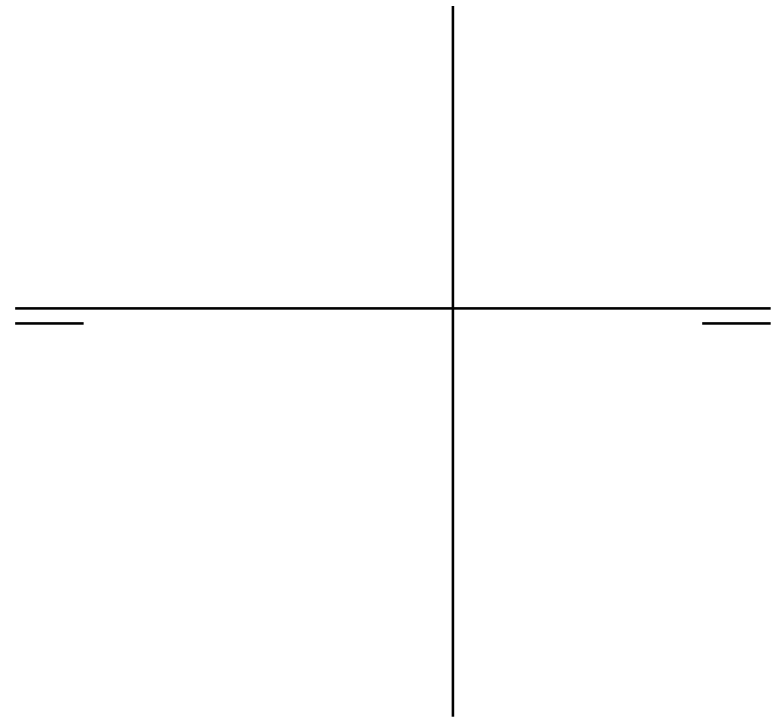
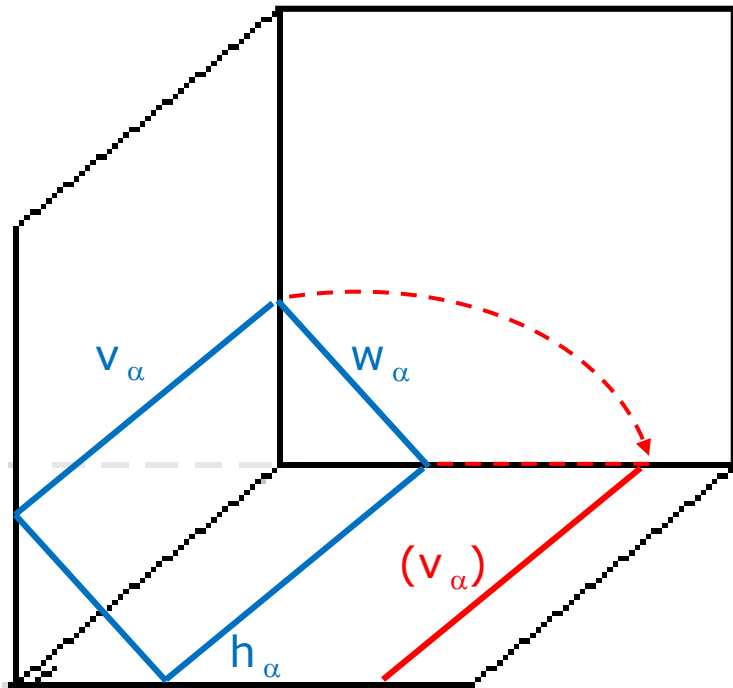

Fold line of a plane II

- Planes parallel to the R.L.

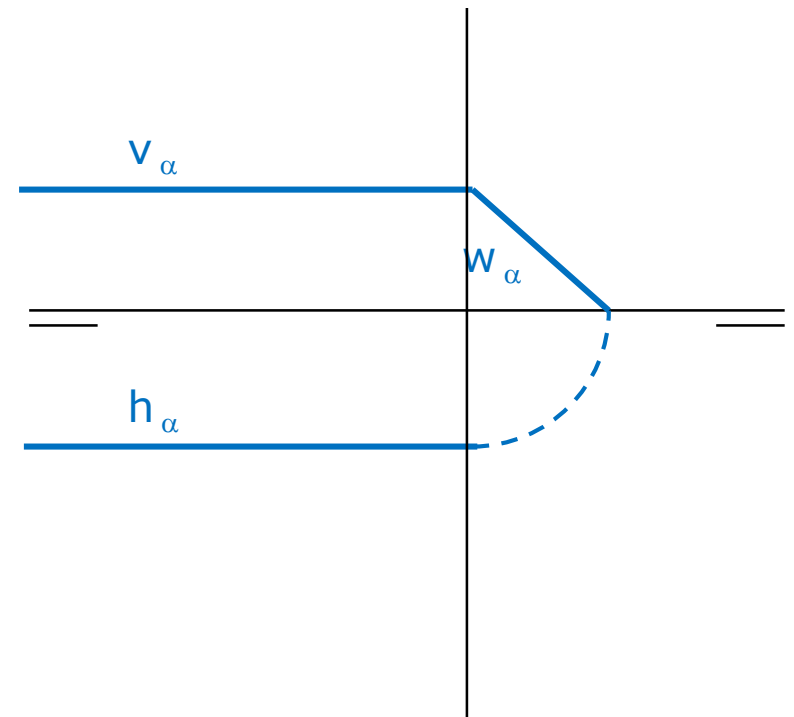
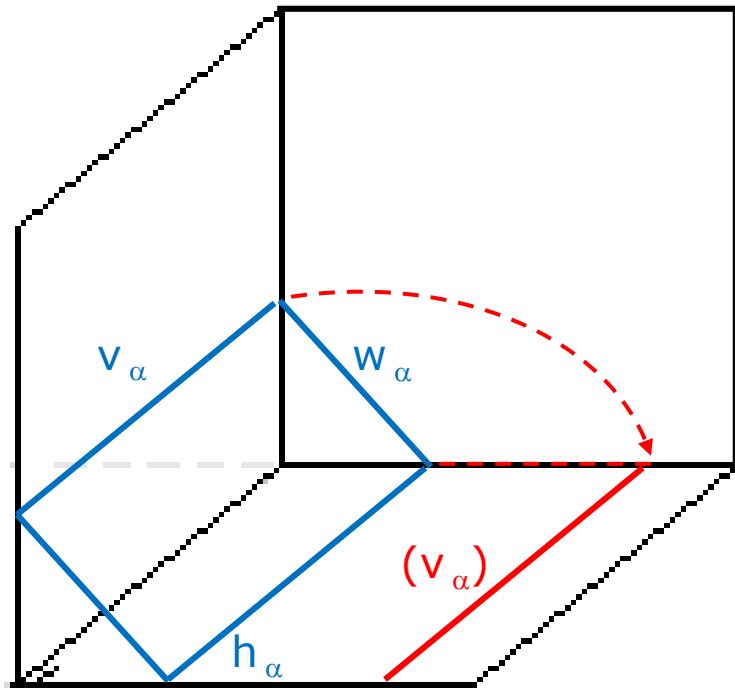

Fold line of a plane II

- Planes parallel to the R.L.

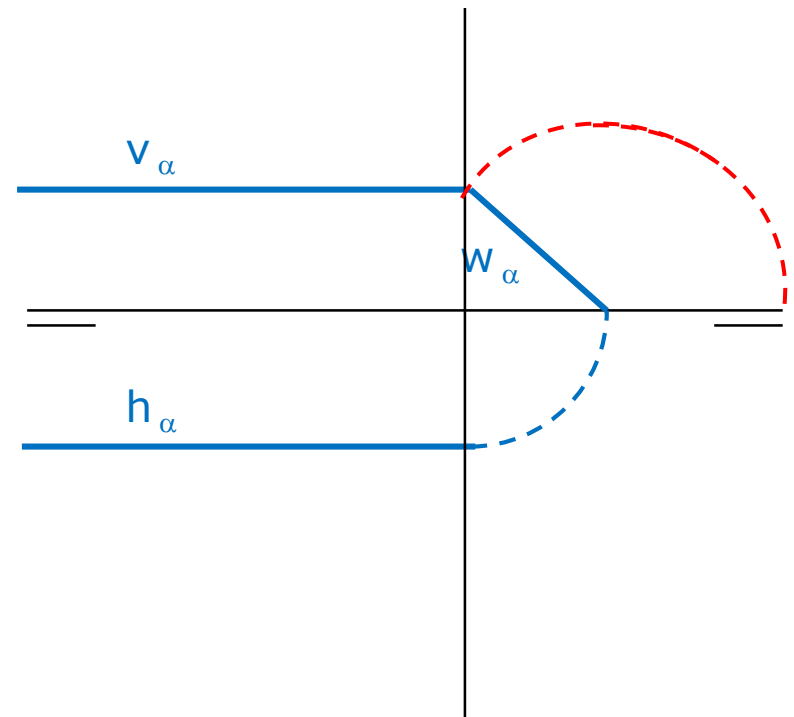
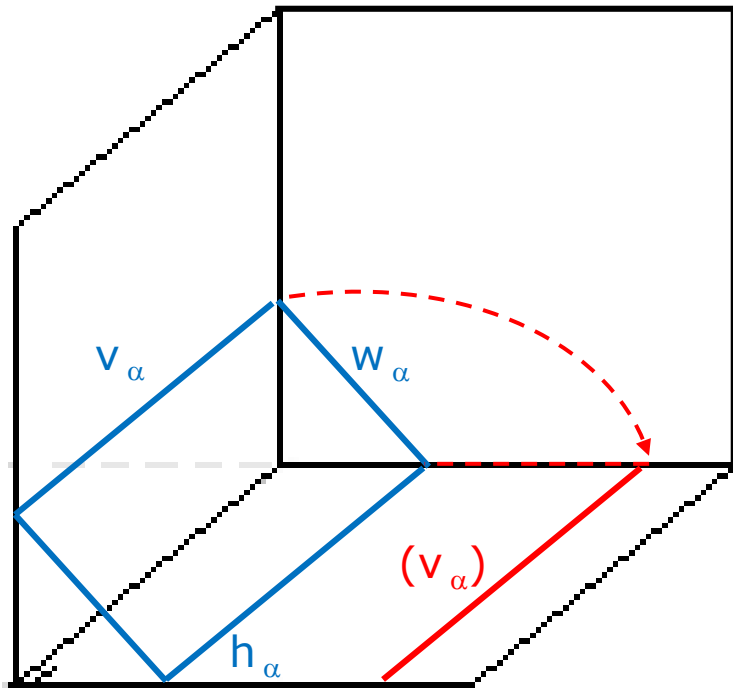

Fold line of a plane II

- Planes parallel to the R.L.

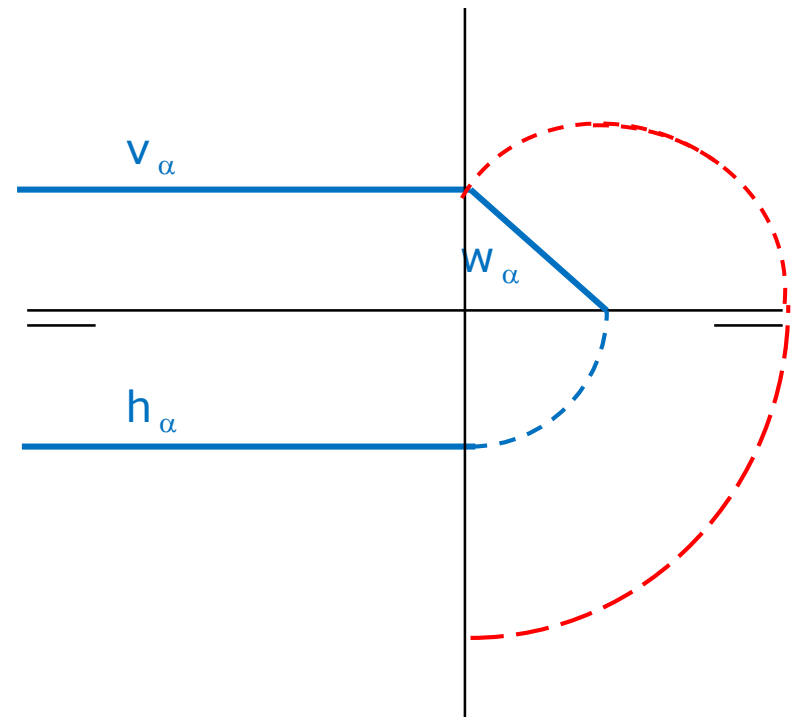
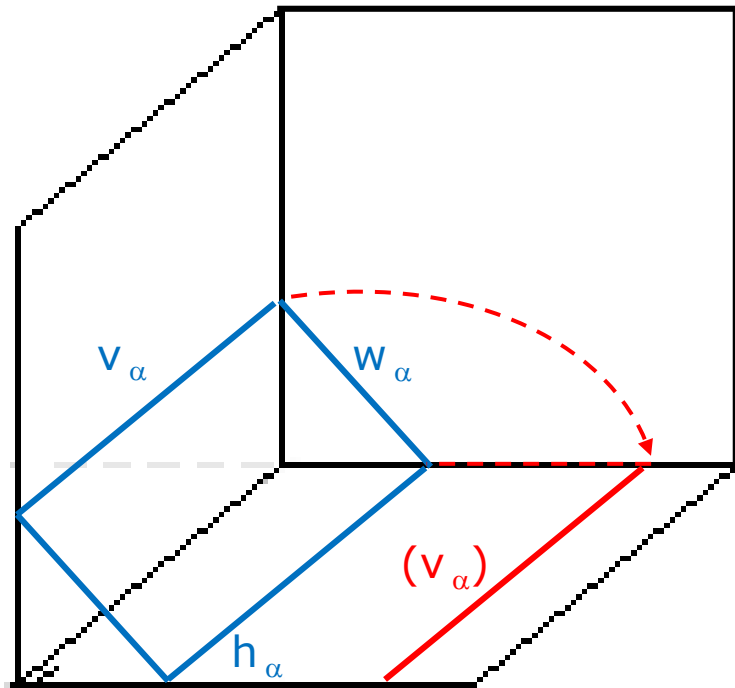

Fold line of a plane II

- Planes parallel to the R.L.

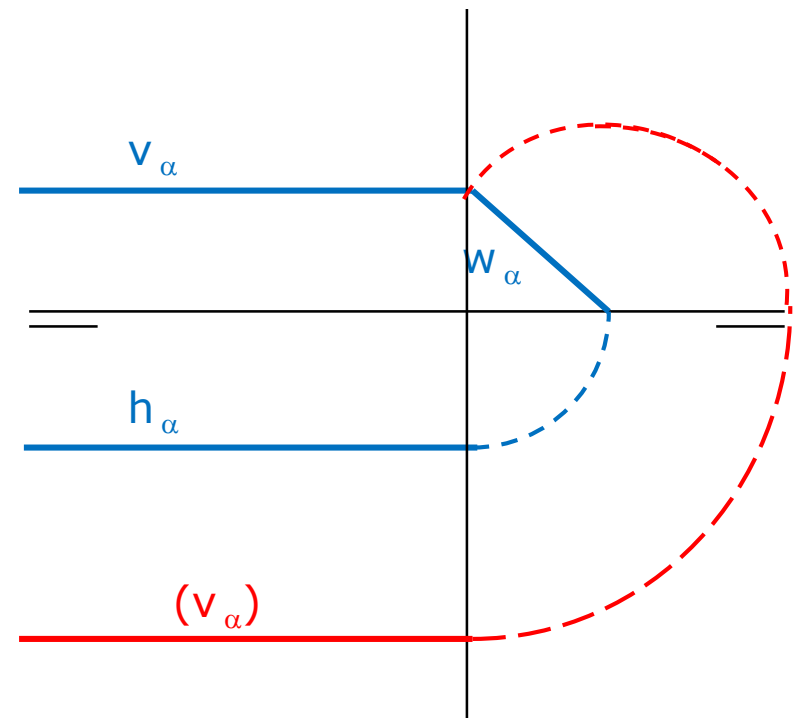
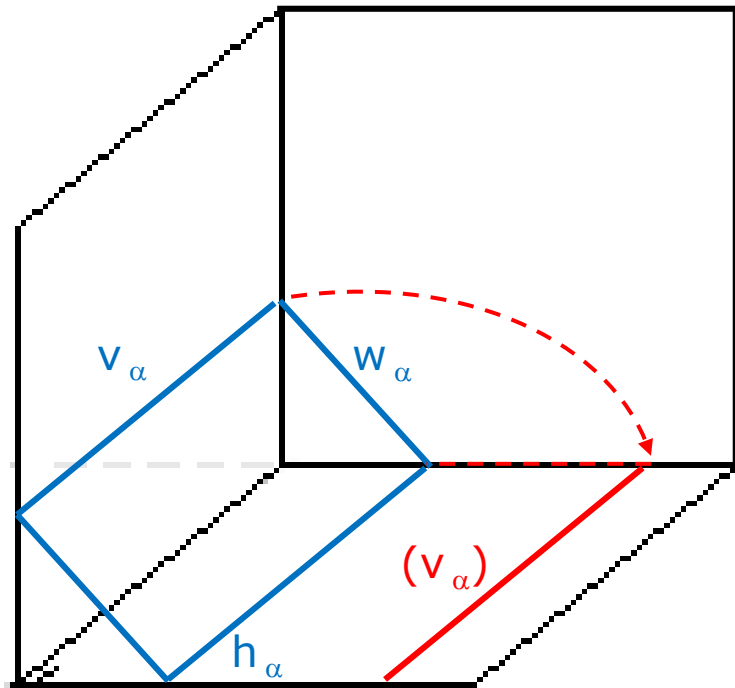

Affinity in folding method

- There is affinity between the projected figure and the folded one.

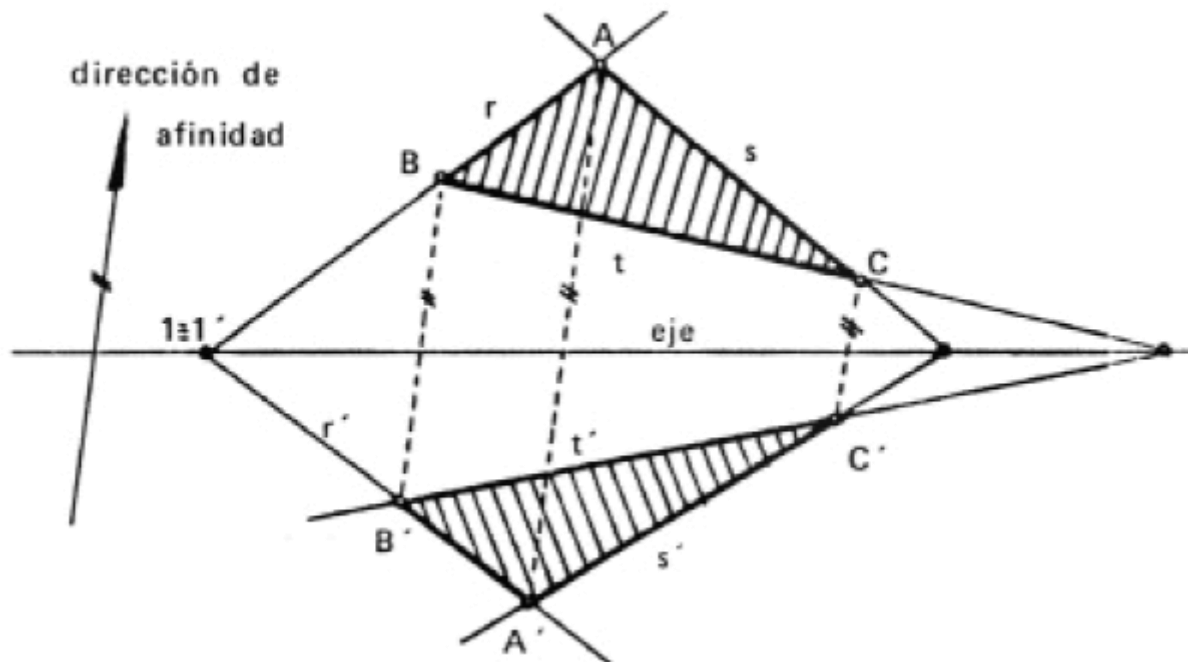

- Pairs of points with affinity are in parallel lines between them and parallel to the affinity direction
- The affinity lines cut in double points in the affinity axis

Representation of a flat figure

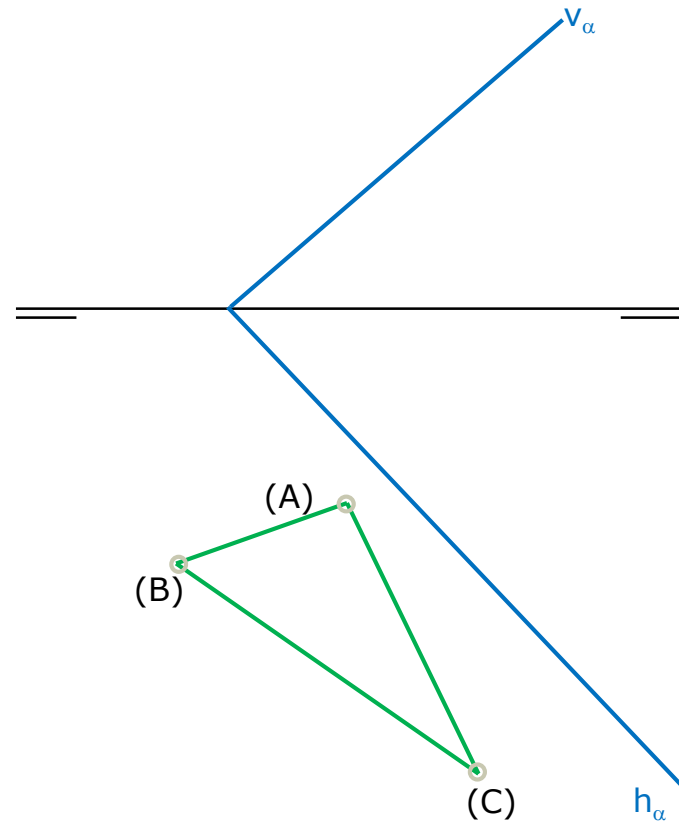

Representation of a flat figure

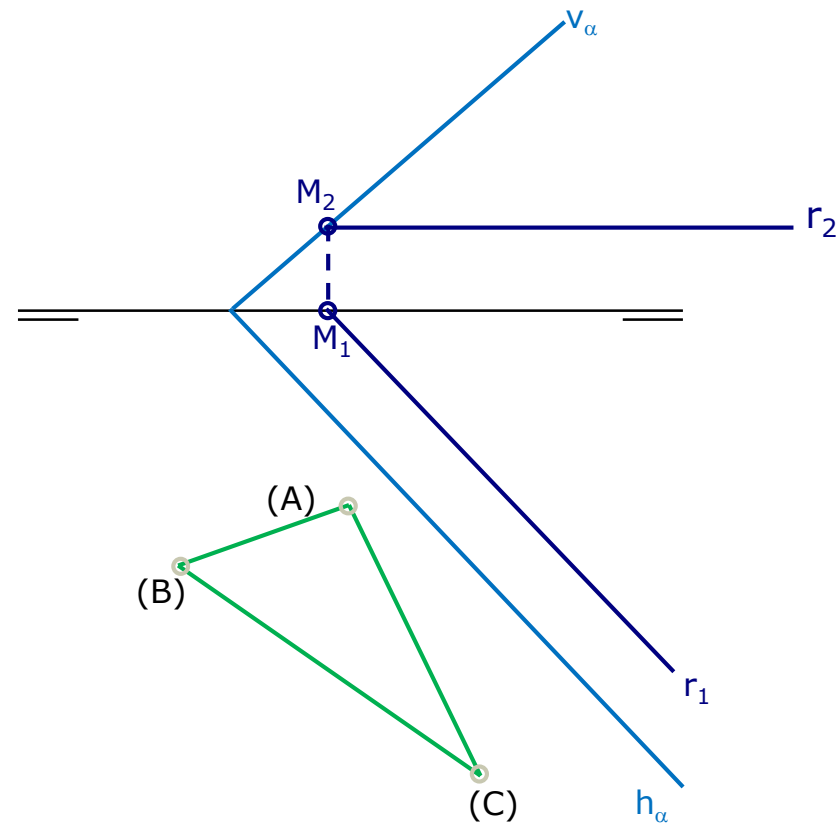

Representation of a flat figure

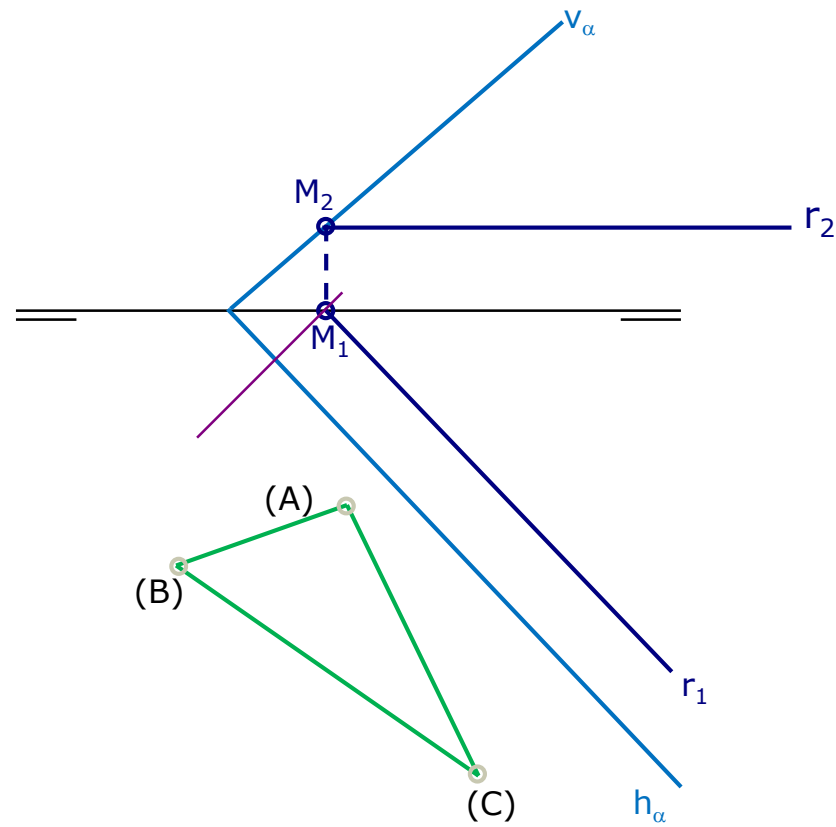

Representation of a flat figure

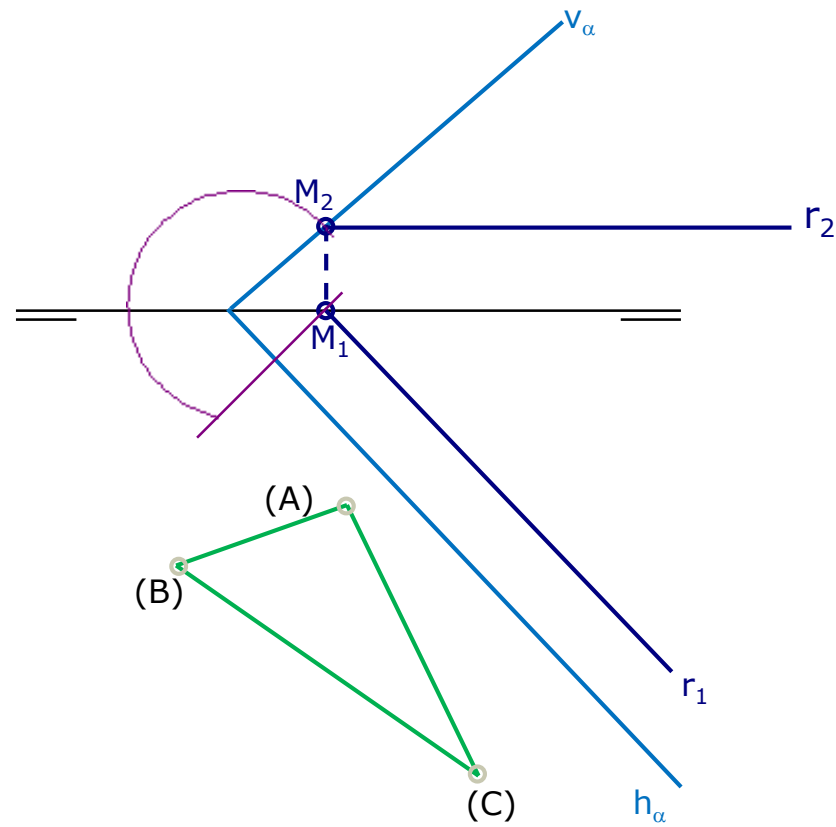

Representation of a flat figure

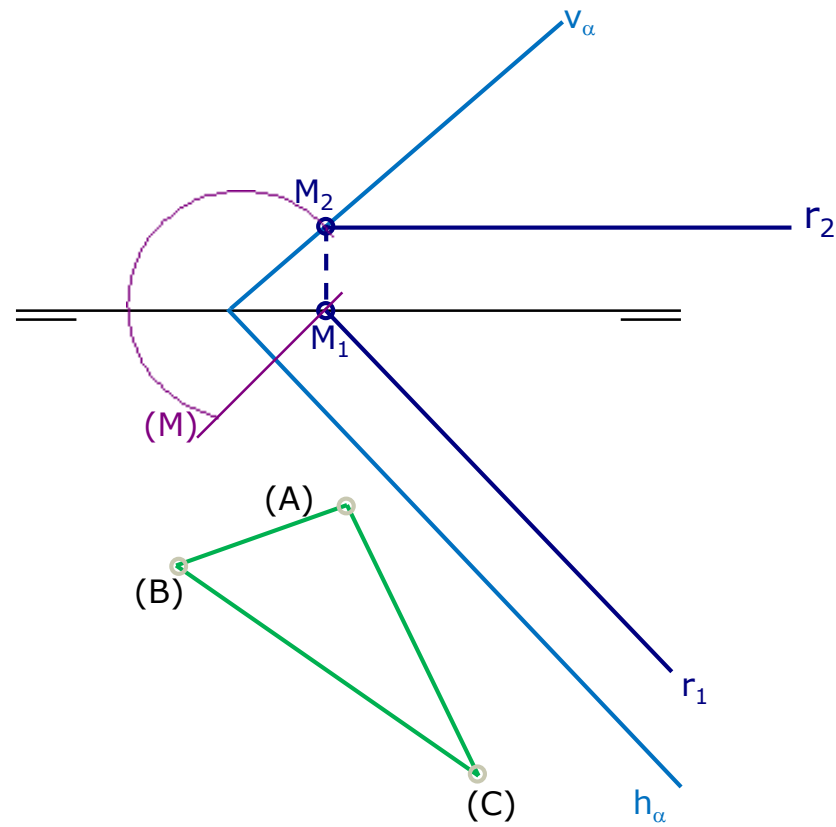

Representation of a flat figure

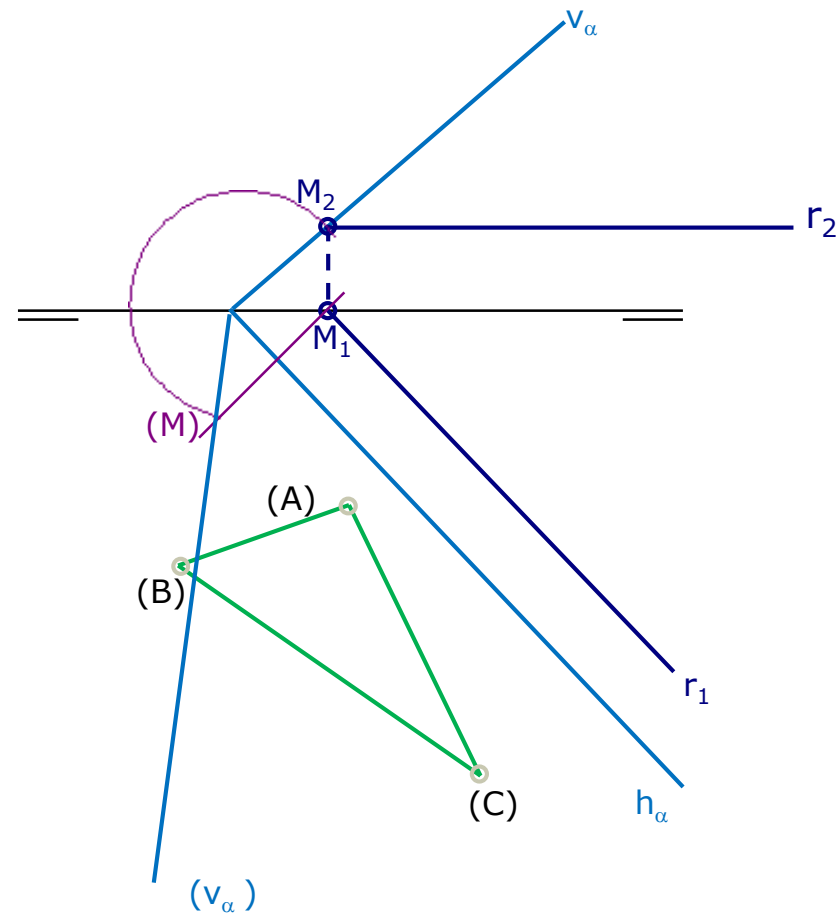

Representation of a flat figure

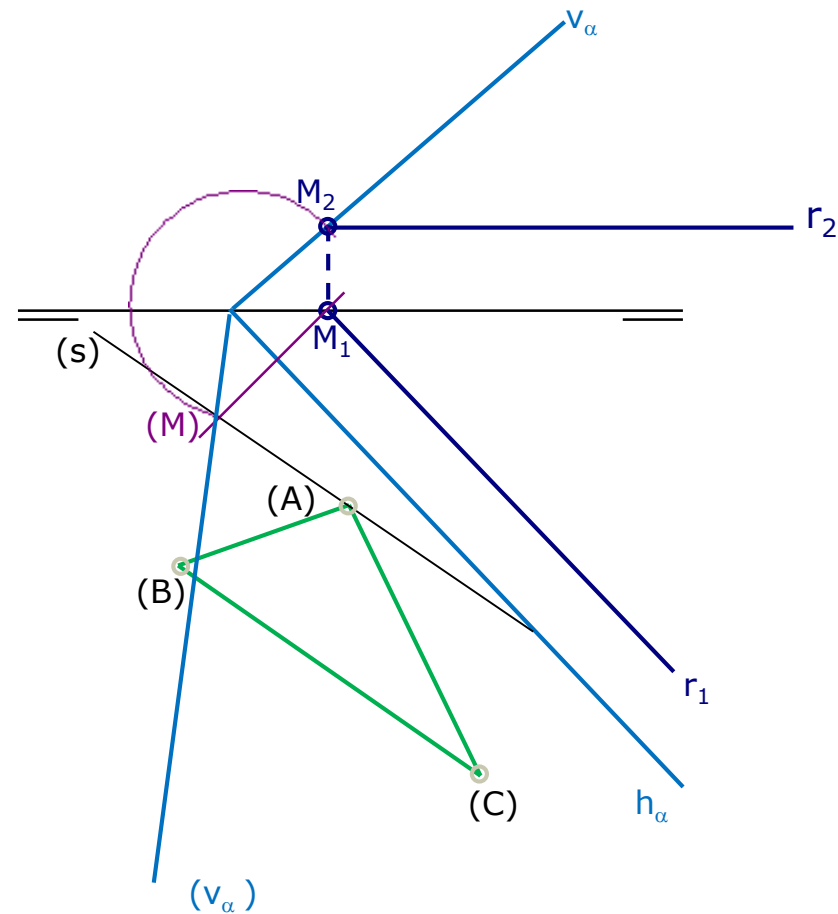

Representation of a flat figure

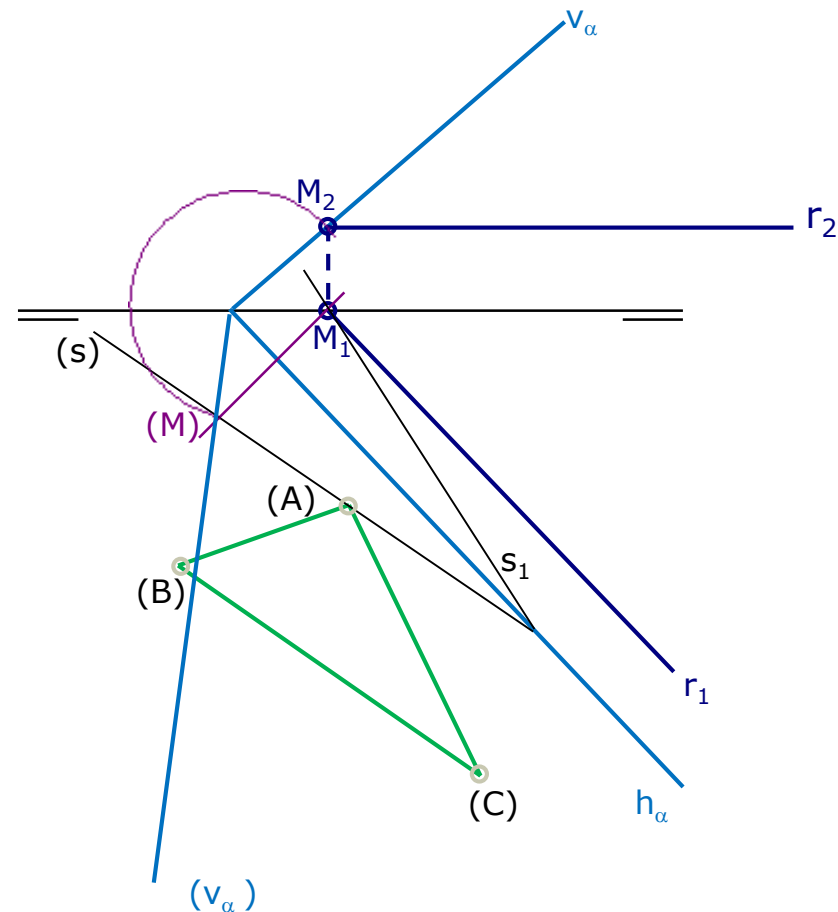

Representation of a flat figure

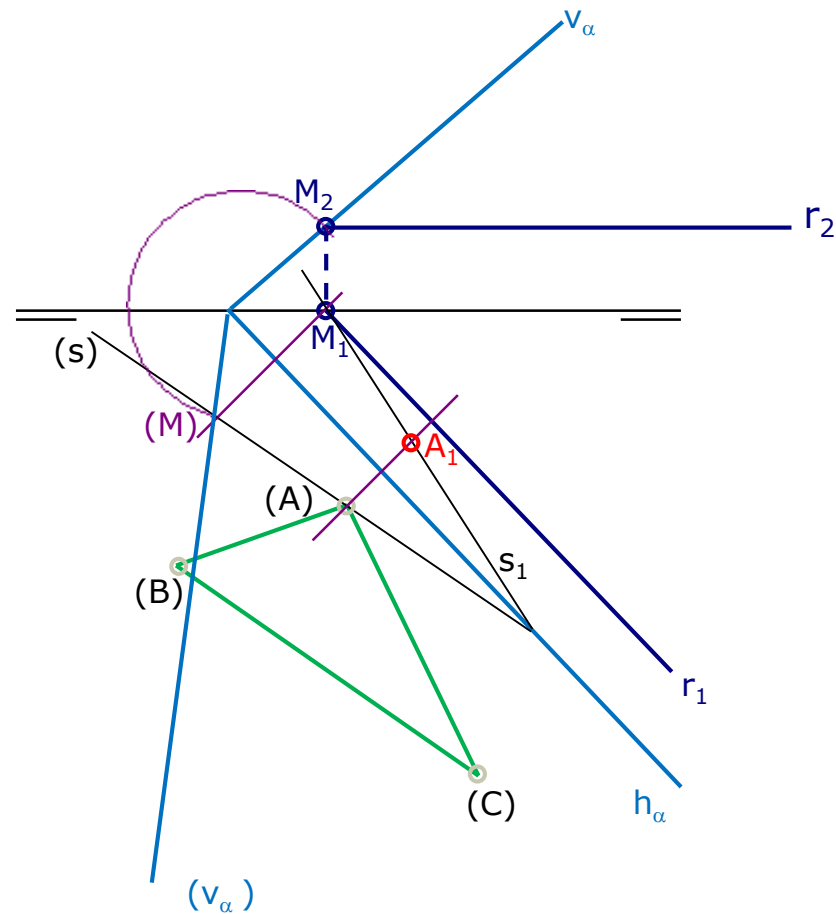

Representation of a flat figure

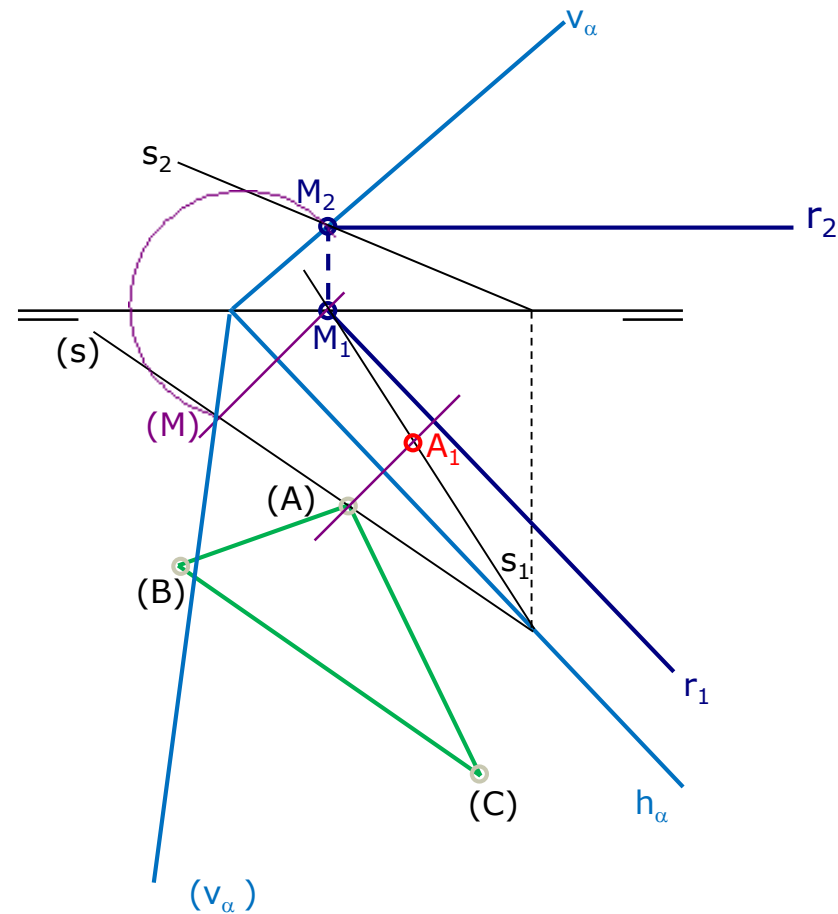

Representation of a flat figure

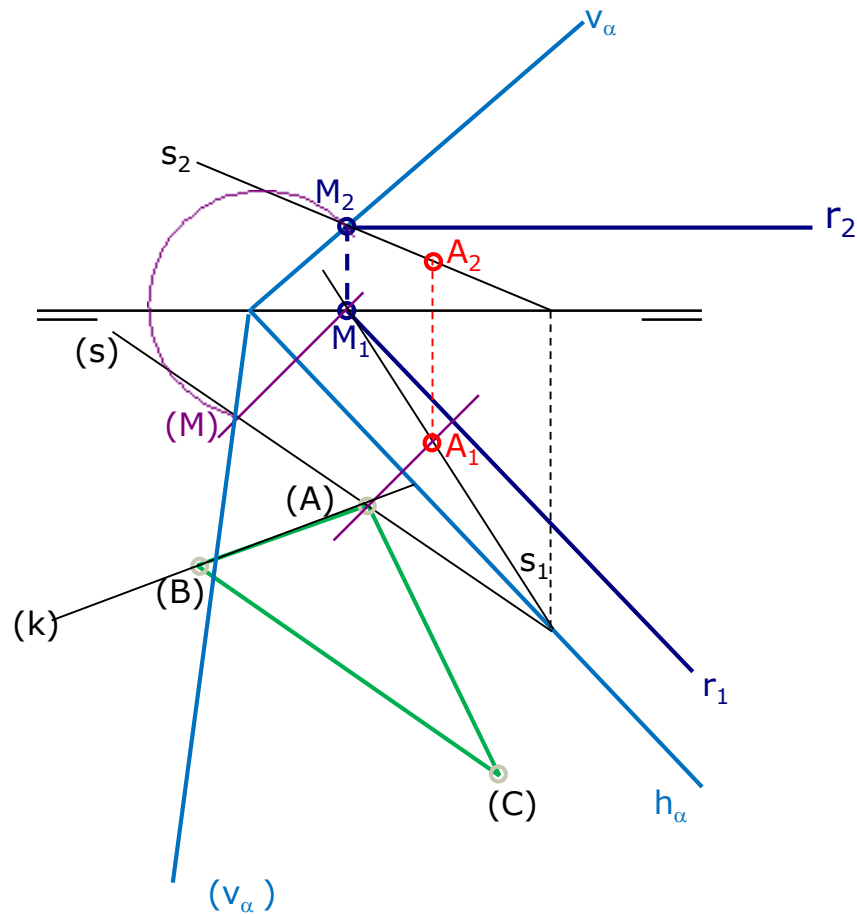

Representation of a flat figure

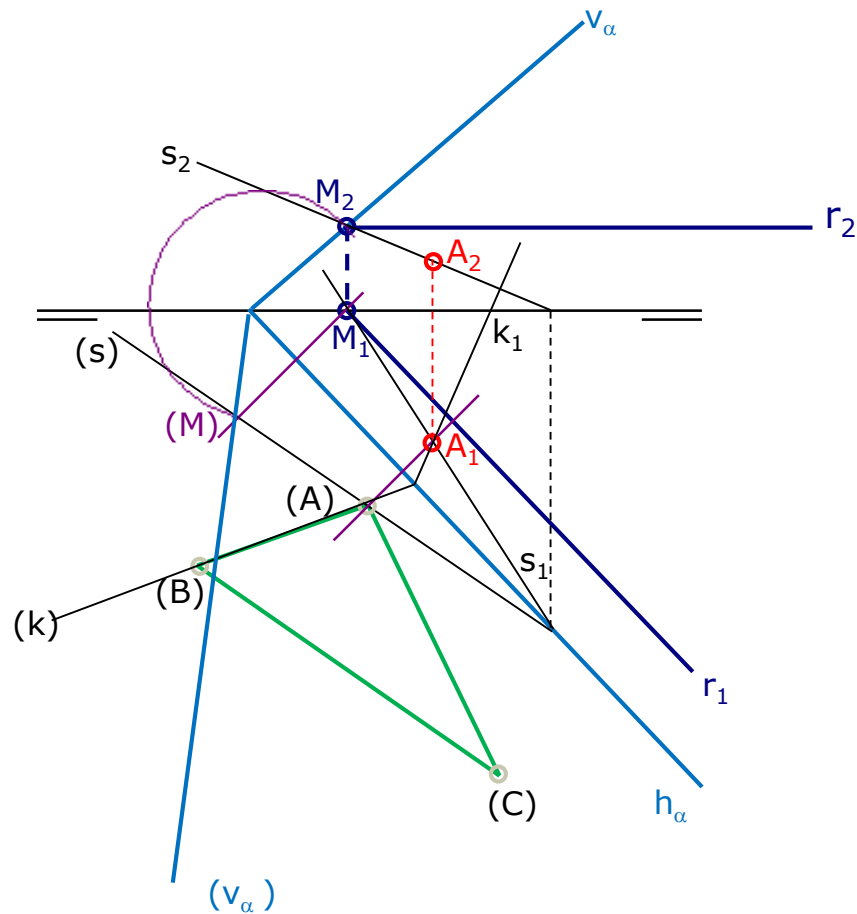

Representation of a flat figure

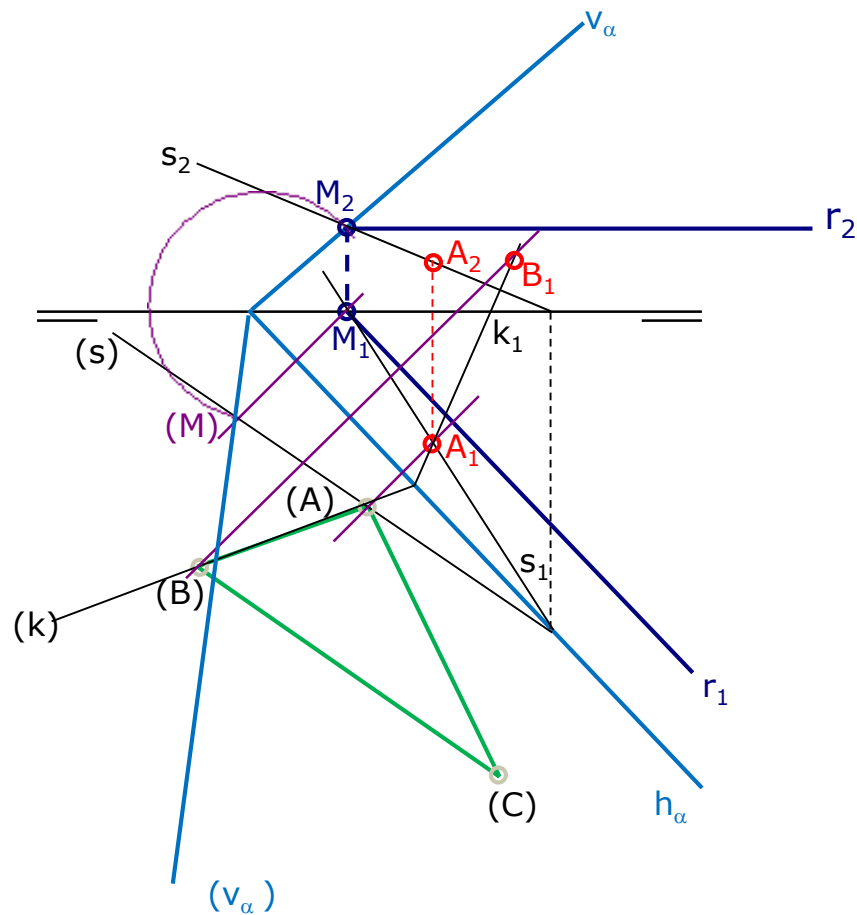

Representation of a flat figure

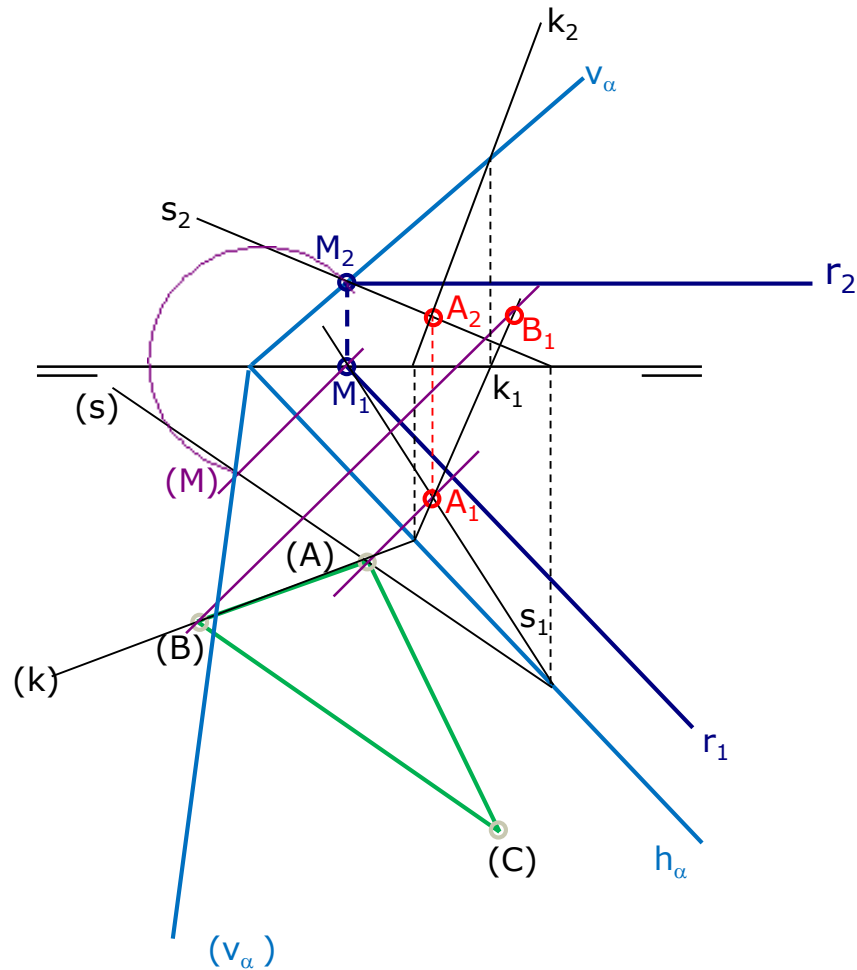

Representation of a flat figure

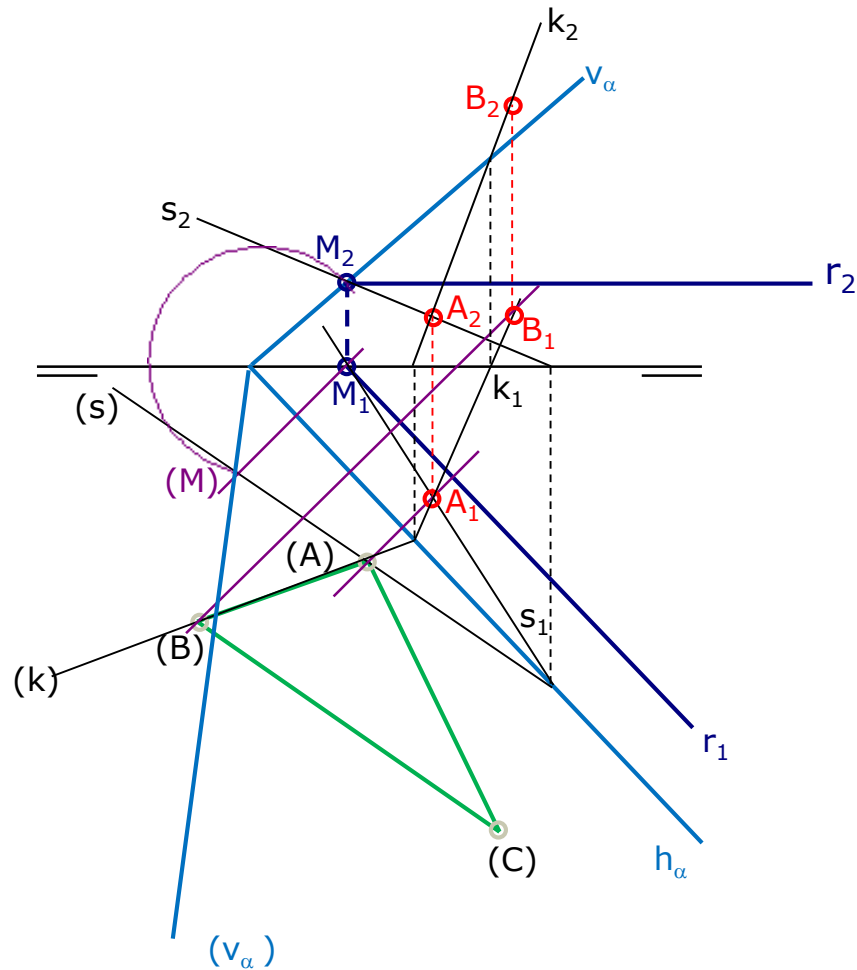

Representation of a flat figure

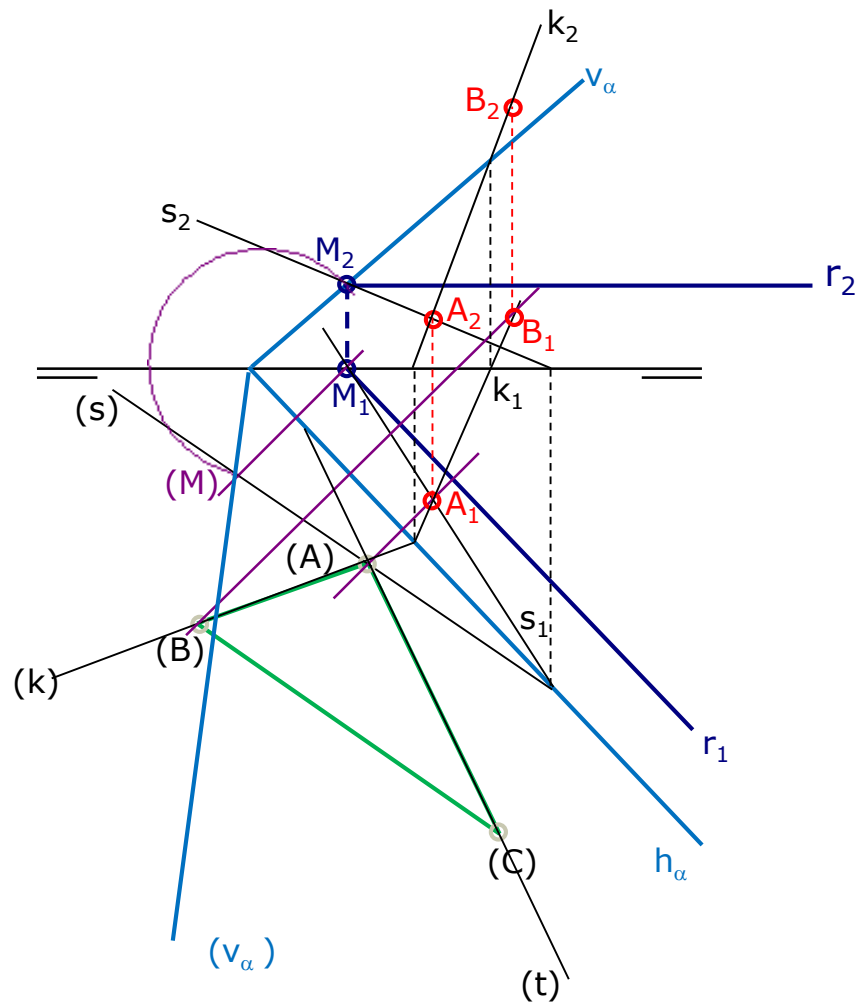

Representation of a flat figure

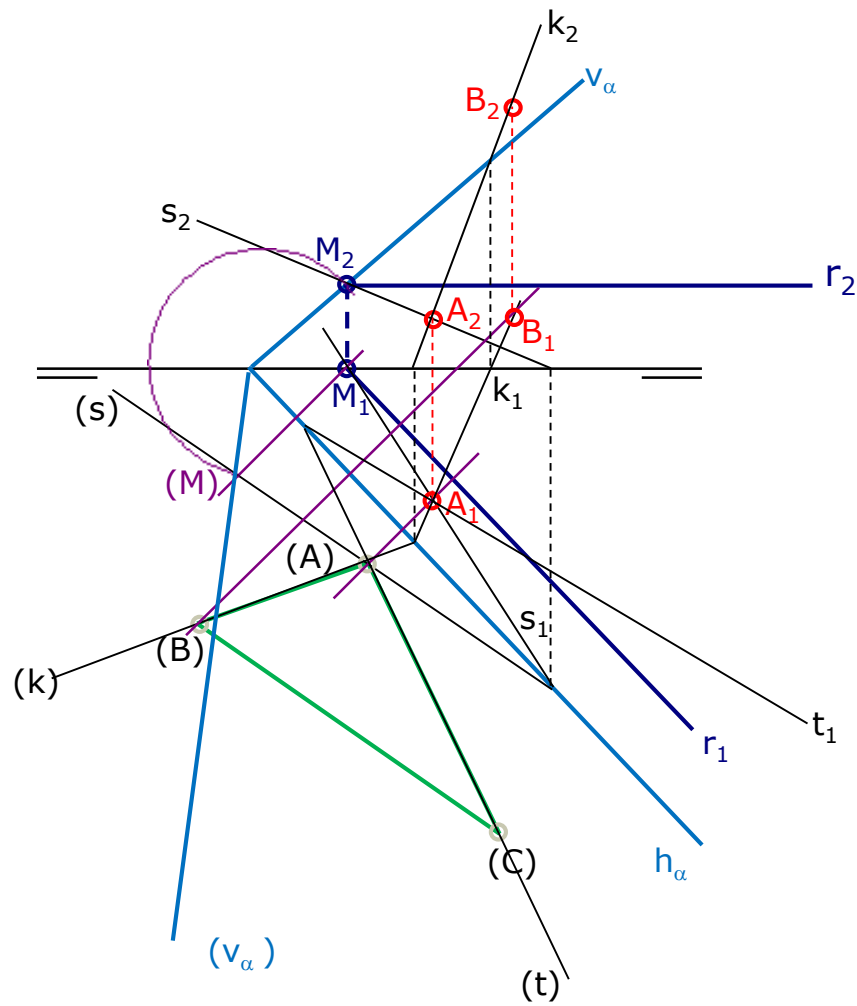

Representation of a flat figure

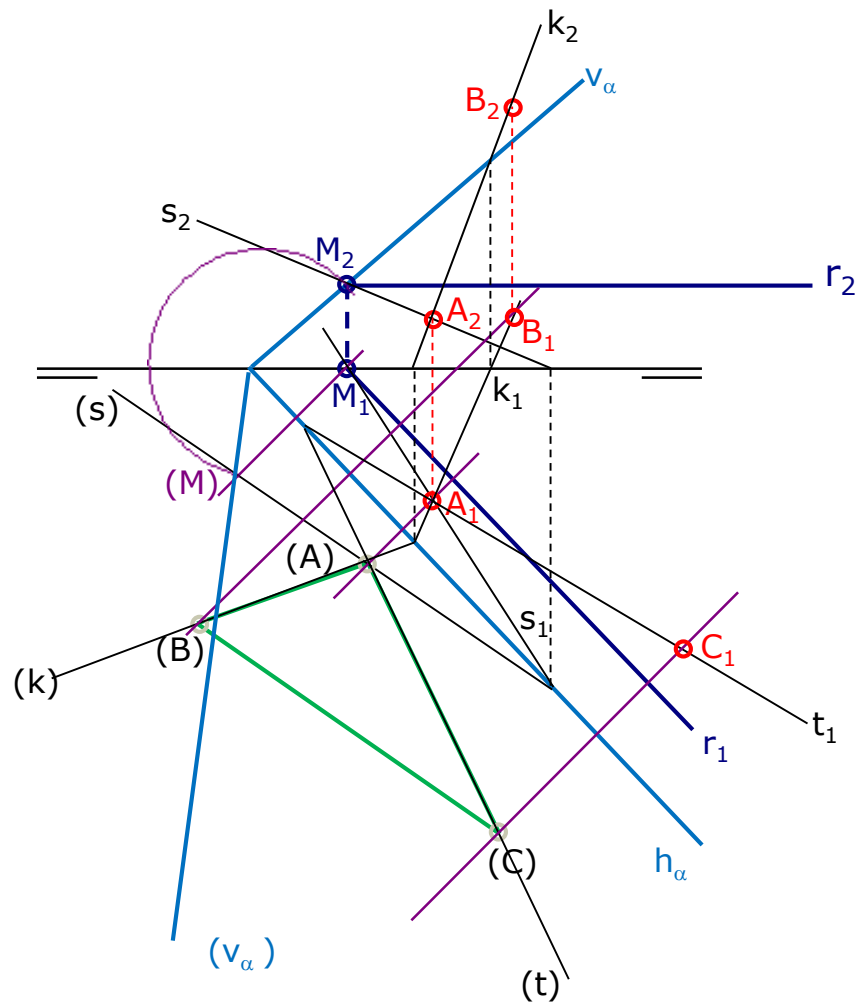

Representation of a flat figure

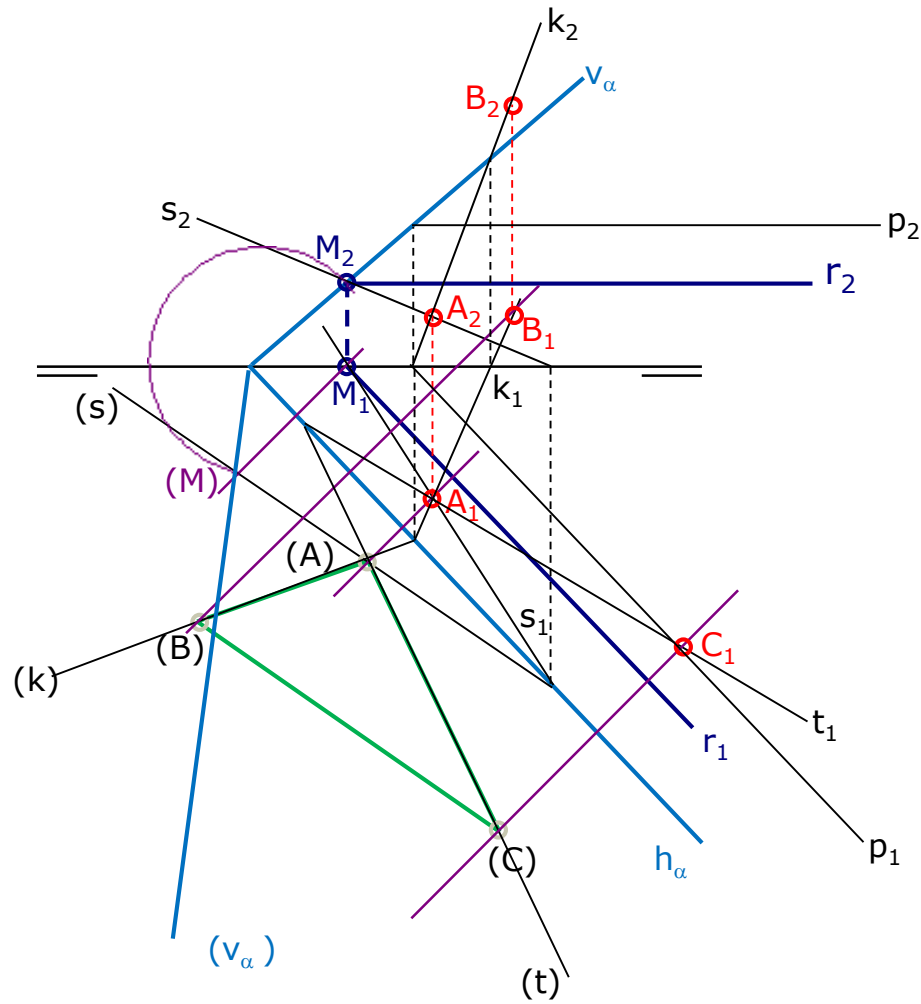

Representation of a flat figure

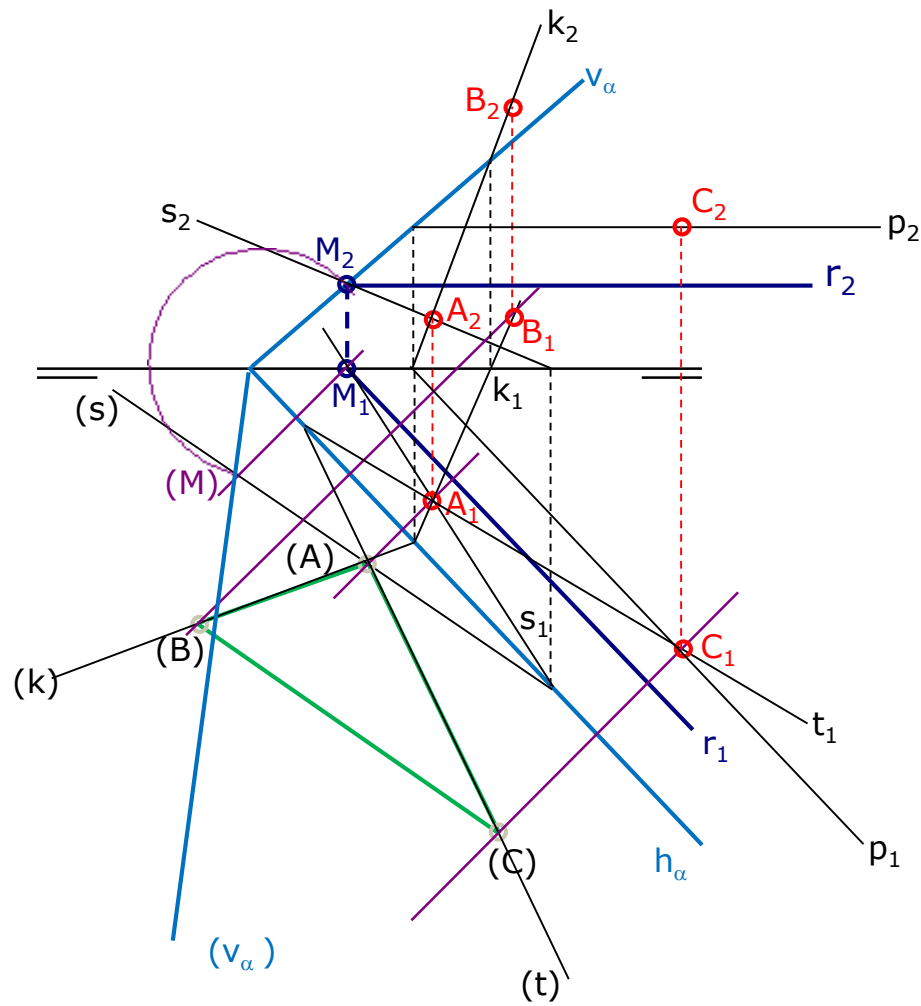

Representation of a flat figure

