

4. Elementary Circuits

Linear Systems and Circuit Theory Applications

Óscar Barquero

Cartagena99

CLASES PARTICULARES, TUTORÍAS TÉCNICAS ONLINE
LLAMA O ENVIA WHATSAPP: 689 45 44 70

ONLINE PRIVATE LESSONS FOR SCIENCE STUDENTS
CALL OR WHATSAPP:689 45 44 70

Contents

- Introduction
- Circuit variables
 - Electric charge
 - Voltage and current
 - Power and Energy
- Circuit elements
 - Voltage and current sources
 - Resistor: Ohm's Law
- Kirchhoff's laws
- Circuit elements association

Cartagena99

CLASES PARTICULARES, TUTORÍAS TÉCNICAS ONLINE
LLAMA O ENVIA WHATSAPP: 689 45 44 70

ONLINE PRIVATE LESSONS FOR SCIENCE STUDENTS
CALL OR WHATSAPP:689 45 44 70

Introduction: Electrical Engineering

- Electrical engineering is the profession that deals with the systems necessary to produce, transmit and measure electrical signals.
- Electrical systems are present in practically all areas:
 - Communications systems
 - Information systems
 - Control systems
 - Power supply systems
 - Signal processing systems
 - Etc.
- The previous systems are not closed blocks but interact and combine among them.

Cartagena99

CLASES PARTICULARES, TUTORÍAS TÉCNICAS ONLINE
LLAMA O ENVÍA WHATSAPP: 689 45 44 70

ONLINE PRIVATE LESSONS FOR SCIENCE STUDENTS
CALL OR WHATSAPP:689 45 44 70

Introduction: Electrical Engineering

- What is the common link between all the previous systems?
- An electrical circuit is a mathematical model that approximates the behavior of a real electrical system.
 - Basis for learning the details of how to design and operate electrical systems.
 - The denomination *electrical circuit* is used to refer both to the real circuit (circuit board) and to the theoretical model of the circuit (schematic).

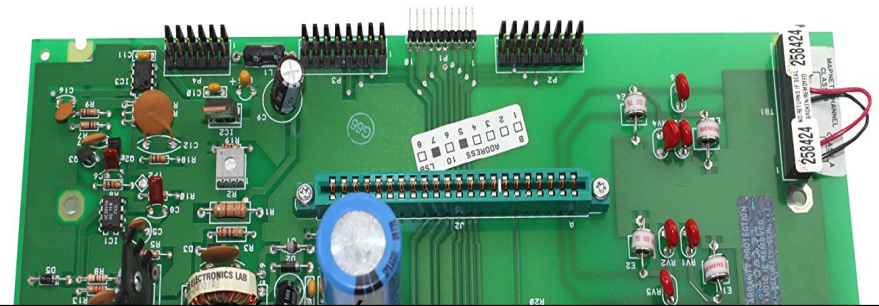
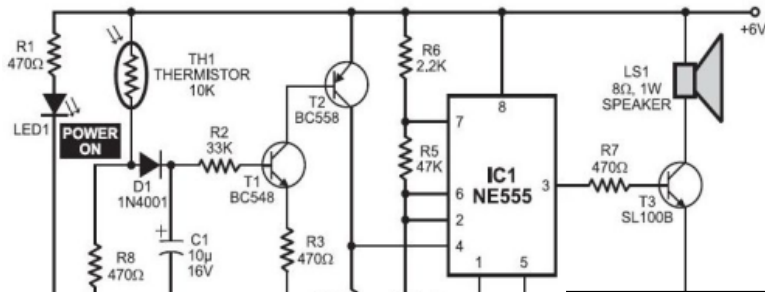

Cartagena99

CLASES PARTICULARES, TUTORIAS TECNICAS ONLINE
LLAMA O ENVIA WHATSAPP: 689 45 44 70

ONLINE PRIVATE LESSONS FOR SCIENCE STUDENTS
CALL OR WHATSAPP:689 45 44 70

Introduction: circuit modeling

- Modeling and analysis of circuit theory has application in multiple systems within the different disciplines of engineering.
- Circuit theory is a special case of the theory of electromagnetic (EM) fields that focuses on the study of static electric and magnetic charges.
- Applying electromagnetic fields theory can be complex for the study of electrical signals, so, under three assumptions, it is possible to use circuit theory instead of the EM approach to study a physical system represented by an electrical circuit:
 - The electrical effects are instantly noticed throughout the system.
 - Signals at the speed of light in physically small systems.
 - Modeling using discrete parameters.
 - The net charge on each component of the system is always zero.

Cartagena99

CLASES PARTICULARES, TUTORÍAS TÉCNICAS ONLINE
LLAMA O ENVÍA WHATSAPP: 689 45 44 70

ONLINE PRIVATE LESSONS FOR SCIENCE STUDENTS
CALL OR WHATSAPP:689 45 44 70

Introduction: circuit modeling

- Circuit theory provides simple solutions (with sufficient precision) to problems that would be excessively complicated if modeled by means of EM theory.
- Instead of working with E and H fields, we will work with V (voltage) and I (current). Easily measurable magnitudes that allow to interpret EM phenomena in a simple way.
- The boundary between the use of circuit theory or the EM approach is usually strongly influenced by the first of the previous assumptions.
- To what extent is a physical system small enough to be modeled by aggregate parameters?
 - We use the 10% rule applied to the electrical dimensions of the circuit.
 - Electrical dimension: dimension in wavelengths ($\lambda = c / f$).
 - Example 1: electric power systems in Spain operate at 50 Hz ($\lambda = 6.10^6 m$)
 - A computer power system has physical dimensions less than 10% of λ , which can be modeled by means of discrete parameters and circuit theory.
 - Example 2: power supply system for a satellite communications antenna operating at around 30 GHz ($\lambda = 10 cm$)

Cartagena99

CLASES PARTICULARES, TUTORÍAS TÉCNICAS ONLINE
LLAMA O ENVÍA WHATSAPP: 689 45 44 70

ONLINE PRIVATE LESSONS FOR SCIENCE STUDENTS
CALL OR WHATSAPP:689 45 44 70

Introduction: International System of Units

- Engineering is a multidisciplinary profession in which teams of engineers work together and share data: it is necessary for everyone to work with common measurement units.
- The International System of Units (IS) is the system used by the main engineering associations and by the majority of engineers.
- The units of the international system are based on 6 base units or quantities:
 - Length, mass, time, electric current, temperature and luminous intensity.
 - The defined magnitudes can be combined to form derived quantities.
- Magnitudes can be:
 - Scalar: completely defined with a single scalar value.
 - Examples: mass, temperature, electric charge, etc.

Cartagena99

CLASES PARTICULARES, TUTORÍAS TÉCNICAS ONLINE
LLAMA O ENVÍA WHATSAPP: 689 45 44 70

ONLINE PRIVATE LESSONS FOR SCIENCE STUDENTS
CALL OR WHATSAPP:689 45 44 70

Introduction Internantional System of Units

- Base quantities:

Magnitude	Unit	Symbol
Length	Meter	m
Mass	Kilogram	kg
Time	Second	s
Electric current	Ampere	A
Temperature	Kelvin	K
Luminous intensity	candela	cd

Cartagena99

CLASES PARTICULARES, TUTORÍAS TÉCNICAS ONLINE
LLAMA O ENVIA WHATSAPP: 689 45 44 70

ONLINE PRIVATE LESSONS FOR SCIENCE STUDENTS
CALL OR WHATSAPP:689 45 44 70

Introduction: International System of Units

- Derived quantities most used in Circuit theory

Magnitude	Basic Unit	Symbol	Dimensional analysis
Frequency	Hertz	Hz	S^{-1}
Force	Newton	N	$kg \cdot m/s^2$
Energy or work	Joule	J	$N \cdot M$
Power	Watts	W	J/s
Electric charge	Coulomb	C	$A \cdot S$
Electric potential	Volt	V	J/C
Electric resistance	Ohms	Ω	V/A
Electric conductance	Siemens	S	A/V
Capacitance	Farads	F	C/V

CLASES PARTICULARES, TUTORÍAS TÉCNICAS ONLINE
 LLAMA O ENVÍA WHATSAPP: 689 45 44 70

ONLINE PRIVATE LESSONS FOR SCIENCE STUDENTS
 CALL OR WHATSAPP: 689 45 44 70

Cartagena99



Introduction: International System of Units

- Most used IS prefixes

Multiplier	Prefix	Symbol
10^{18}	exa	E
10^{15}	peta	P
10^{12}	tera	T
10^9	giga	G
10^6	mega	M
10^3	kilo	k
1		
10^{-3}	mili	m
10^{-6}	micro	μ
10^{-9}	nano	n
10^{-12}	pico	p

Cartagena99

CLASES PARTICULARES, TUTORÍAS TÉCNICAS ONLINE
LLAMA O ENVÍA WHATSAPP: 689 45 44 70

ONLINE PRIVATE LESSONS FOR SCIENCE STUDENTS
CALL OR WHATSAPP:689 45 44 70

Circuit variables

Cartagena99

CLASES PARTICULARES, TUTORÍAS TÉCNICAS ONLINE
LLAMA O ENVIA WHATSAPP: 689 45 44 70

ONLINE PRIVATE LESSONS FOR SCIENCE STUDENTS
CALL OR WHATSAPP:689 45 44 70

Circuit variables: electric charge q

- The concept of electric charge is the basis for describing all electrical phenomena.
- Charge is an intrinsic property of subatomic particles.
- Electric charge is bipolar:
 - Electrical effects described in terms of positive and negative charges.
- e : fundamental unit of the electric charge.
 - 1 proton: charge $+e$.
 - 1 electron: charge $-e$.
 - Any charge Q is an integer multiple of e ($Q = \pm Ne$).
 - Electric charge is measured in Coulombs [C]: $1C = 1A \cdot s$.

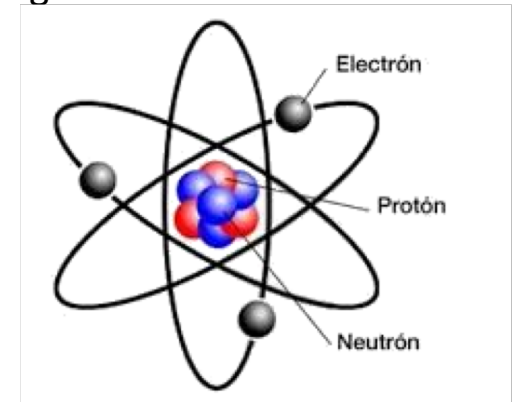

$$e = 1.6022 \times 10^{-19} \text{ C}$$

- Electrical phenomena can be attributed to the separation of the charges and their

movement

Cartagena99

CLASES PARTICULARES, TUTORÍAS TÉCNICAS ONLINE
LLAMA O ENVÍA WHATSAPP: 689 45 44 70

ONLINE PRIVATE LESSONS FOR SCIENCE STUDENTS
CALL OR WHATSAPP:689 45 44 70

Circuit variables: voltage

- When the negative and positive charges are separated, energy is consumed in the process.
 - The electron separates from the atom and moves to the orbital gaps of other atoms.
- The voltage, or electric potential difference, is the energy per unit of charge created by the separation of said charges:

$$v = \frac{dw}{dq}$$

- v = voltaje in volts
 - w = energy in joules
 - q = electric charge in coulombs
- Voltage is measured in **volts** [V]: $1V = \frac{1J}{1C}$.

Cartagena99

CLASES PARTICULARES, TUTORÍAS TÉCNICAS ONLINE
LLAMA O ENVÍA WHATSAPP: 689 45 44 70

ONLINE PRIVATE LESSONS FOR SCIENCE STUDENTS
CALL OR WHATSAPP:689 45 44 70

Circuit variables: current

- Electrical effects caused by the movement of charges along a conductor depend on the flow rate of said charges.
- The flow rate of the charge is known as electric current or current intensity:

$$i = \frac{dq}{dt}$$

- i = current in amperes,
- q = electric charge in coulombs,
- t = time in seconds

- Current is measured in **amperes** [A].

Cartagena99

CLASES PARTICULARES, TUTORÍAS TÉCNICAS ONLINE
LLAMA O ENVÍA WHATSAPP: 689 45 44 70

ONLINE PRIVATE LESSONS FOR SCIENCE STUDENTS
CALL OR WHATSAPP:689 45 44 70

Circuit variables: DC vs AC

- In general, **voltage and current**, vary as a function of **time**:

$$v = v(t) [V], i = i(t) [A]$$

- Direct voltaje and current:
 - They do not vary with time,
 - Are denoted by V and I ,
 - So-called DC (*Direct Current*).
- Alternating voltaje and current:
 - Periodic variation with time,
 - Denoted by v and i ,
 - So-called AC (*Alternating Current*).
- Particular case of alternating current:
 - v and i have a sinusoidal variation (T6).

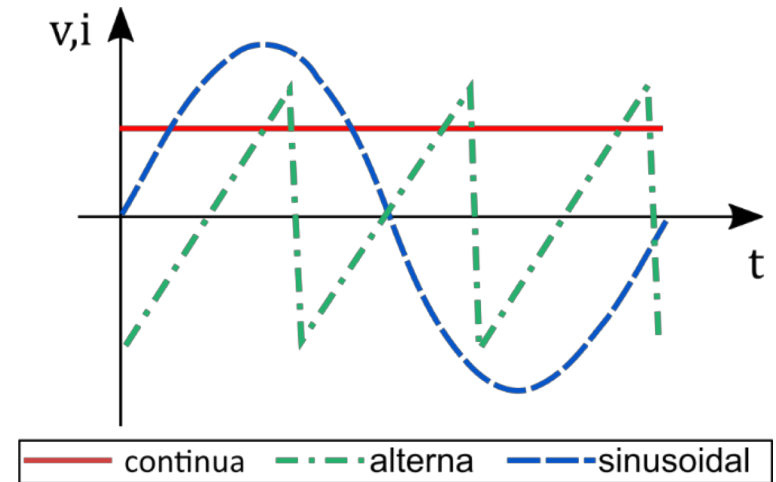

Cartagena99

CLASES PARTICULARES, TUTORÍAS TÉCNICAS ONLINE
LLAMA O ENVÍA WHATSAPP: 689 45 44 70

ONLINE PRIVATE LESSONS FOR SCIENCE STUDENTS
CALL OR WHATSAPP:689 45 44 70

Circuit variables: polarity

- The previous definitions of voltage and current refer to a magnitude.
- Given the bipolar nature of the charge, to accurately define voltage and current, it is necessary to indicate:
 - its magnitude (a number \mathbb{R} o \mathbb{C}),
 - its polarity (a sign):
 - For the polarity of the voltage, a '+' sign is used for the side with the highest potential and a '-' sign for the side with the lowest potential. We speak of voltage drop from point 1 to 2.

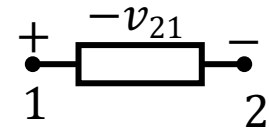
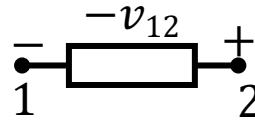
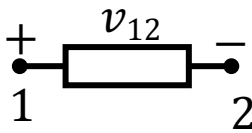

- For the polarity of the current an arrow indicating the direction of circulation is used.

Cartagena99

CLASES PARTICULARES, TUTORÍAS TÉCNICAS ONLINE
LLAMA O ENVÍA WHATSAPP: 689 45 44 70

ONLINE PRIVATE LESSONS FOR SCIENCE STUDENTS
CALL OR WHATSAPP:689 45 44 70

Circuit variables: ideal basic circuit element

- The ideal basic circuit element has 3 attributes:
 - It only has two terminals (connection points with other components),
 - It is described mathematically as a function of current and / or voltage, and
 - it can not be subdivided into other elements.
- ***Ideal*** denotes that the element is not physically implementable.
 - However, several ideal basic elements can be combined to model a real circuit element, as will be seen next
- There are **5 basic circuit elements** (ideal)
 - **Voltage sources**
 - **Current sources**
 - **Resistors**
 - **Inductors**
 - **Capacitors**

Cartagena99

CLASES PARTICULARES, TUTORÍAS TÉCNICAS ONLINE
LLAMA O ENVÍA WHATSAPP: 689 45 44 70

ONLINE PRIVATE LESSONS FOR SCIENCE STUDENTS
CALL OR WHATSAPP:689 45 44 70

Circuit variables: ideal basic circuit element

- Each element is modeled as a black box, characterized by its current and voltage at its terminals.
- Assignments of the reference polarity for the voltage and the reference direction for the current are arbitrary, but once they are defined, they cannot be changed.

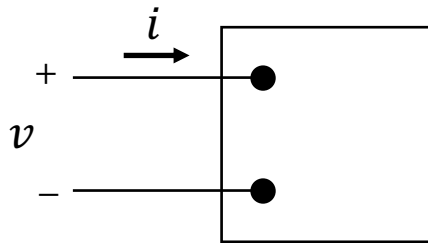

EQUIVALENT CIRCUIT MODEL (I)

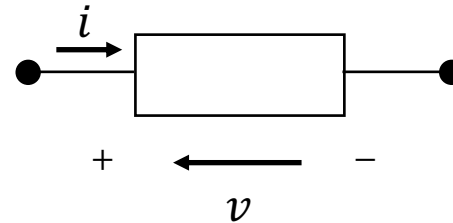

EQUIVALENT CIRCUIT MODEL (II)

PASSIVE SIGNS CONVENTION: Whenever the reference direction for the current passing through an element is coincident with the direction of the voltage drop in

Cartagena99

CLASES PARTICULARES, TUTORÍAS TÉCNICAS ONLINE
LLAMA O ENVIA WHATSAPP: 689 45 44 70

ONLINE PRIVATE LESSONS FOR SCIENCE STUDENTS
CALL OR WHATSAPP:689 45 44 70

Circuit variables: power and energy

- Measurement of power and energy in a circuit is very useful because:
 - The output of the modeled system is often non-electrical in nature (e.g. motor, heating device, antenna, toaster, loudspeaker, etc.).
 - All practical devices have limitations regarding the maximum power they can handle.
- Therefore, in the design process, calculations of voltages and currents are not sufficient by themselves and it is necessary to use other variables: power and energy.
- **Power is the variation of energy per time unit:**

$$p = \frac{dw}{dt}$$

- p = power in watts,
- w = energy in joules,
- t = time in seconds.

Cartagena99

CLASES PARTICULARES, TUTORÍAS TÉCNICAS ONLINE
LLAMA O ENVÍA WHATSAPP: 689 45 44 70

ONLINE PRIVATE LESSONS FOR SCIENCE STUDENTS
CALL OR WHATSAPP:689 45 44 70

Circuit variables: power and energy

- Power, referred to charge flow, is obtained directly from the definition of the voltage and current equations of slides 11 and 12: $p = \frac{dw}{dt} = \left(\frac{dw}{dq}\right) \left(\frac{dq}{dt}\right)$.

- So that power associated with a basic circuit element is nothing more than the product of the current that passes through the element by the voltage that falls on it.

$$p = v \cdot i$$

- p = power in watts,
- v = voltage in volts,
- i = current in amperes.

- Power is a magnitude associated to a pair of terminals and we must be able, with our calculations, to know if power is supplied to those terminals or if power is extracted from them.
 - If power is positive ($p > 0$), power will be delivered to the element.
 - If power is negative ($p < 0$), power will be drawn from the element.
- Power budget or power balancing: The sum of power associated with each element of a circuit is zero: $\sum_i P_i = 0$

Cartagena99

CLASES PARTICULARES, TUTORÍAS TÉCNICAS ONLINE
LLAMA O ENVÍA WHATSAPP: 689 45 44 70

- - -

ONLINE PRIVATE LESSONS FOR SCIENCE STUDENTS
CALL OR WHATSAPP: 689 45 44 70

Circuit variables: power and energy

- In a circuit element:
 - energy is produced,
 - energy is consumed (either because it is dissipated, or because it is stored),
 - energy is transported.
- According to the different behaviors (in relation to energy), the following classification of circuit elements can be established:
 - Active elements: produce energy by means electric potential differences, so that the movement of electrons occurs (sources or generators).
 - Passive elements: consume energy, either because they dissipate it, or because they store it (Resistances, Inductances and Capacitors).
 - Conductor wires: connect active and passive elements within a circuit, introducing

Cartagena99

CLASES PARTICULARES, TUTORÍAS TÉCNICAS ONLINE
LLAMA O ENVÍA WHATSAPP: 689 45 44 70

ONLINE PRIVATE LESSONS FOR SCIENCE STUDENTS
CALL OR WHATSAPP:689 45 44 70

Circuit variables: power and energy

- Example: calculate the power expression of the basic element of the circuit according to the polarities assigned to the voltage and to the current in each case.

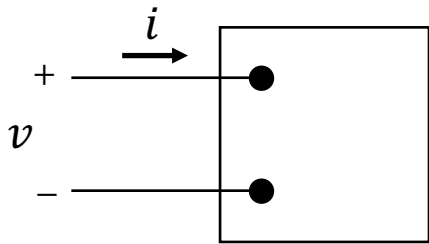

$$p = v \cdot i$$

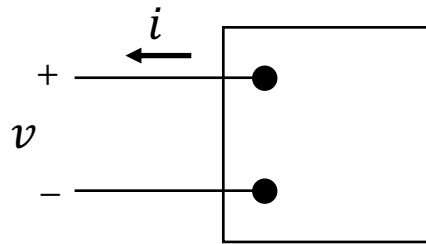

$$p = -v \cdot i$$

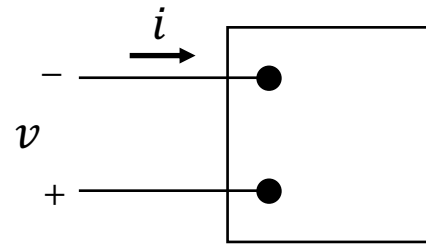

$$p = -v \cdot i$$

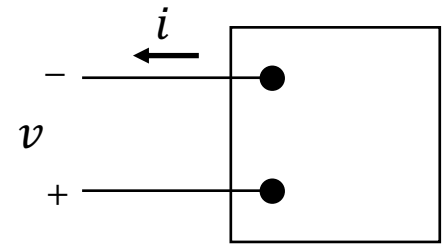

$$p = v \cdot i$$

Cartagena99

CLASES PARTICULARES, TUTORÍAS TÉCNICAS ONLINE
LLAMA O ENVÍA WHATSAPP: 689 45 44 70

ONLINE PRIVATE LESSONS FOR SCIENCE STUDENTS
CALL OR WHATSAPP:689 45 44 70

Circuit elements

Cartagena99

CLASES PARTICULARES, TUTORÍAS TÉCNICAS ONLINE
LLAMA O ENVIA WHATSAPP: 689 45 44 70

ONLINE PRIVATE LESSONS FOR SCIENCE STUDENTS
CALL OR WHATSAPP:689 45 44 70

Circuit elements: electric resistor (Ohm's Law)

- Resistance is the ability of materials to oppose to the current flow or, more specifically, the flow of electrical charge.
- The circuit element used to model this behavior is called resistor.
 - The electrons in motion forming the electric current interact with the atomic structure of the material through which they propagate, which tends to retard them.
 - In the course of these interactions, part of the electrical energy is converted into thermal energy and dissipates in the form of heat (Joule's effect).
 - This effect is not desirable in energy transport applications, for example, but it is the basis of operation of systems based on resistance heating such as stoves, toasters, irons, etc.
 - Most materials offer a resistance to current flow that can be easily measured with a multimeter and that depends on the constitutive parameters of the material (ϵ_r , σ).
 - Some materials such as copper and aluminum, which are good conductors, have a very small resistance and are used to implement cables, since the Joule losses are small.

Cartagena99

CLASES PARTICULARES, TUTORIAS TECNICAS ONLINE
LLAMA O ENVIA WHATSAPP: 689 45 44 70

ONLINE PRIVATE LESSONS FOR SCIENCE STUDENTS
CALL OR WHATSAPP:689 45 44 70

Circuit elements: electric resistor (Ohm's Law)

- Resistors are graphically represented in circuit schematics as:

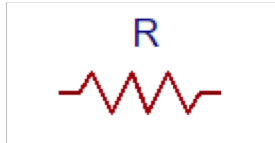

- Resistance is measured in **Ohms**: $R[\Omega]$ (alternatively $R[\text{Ohm}]$).
- The previous representation is the American style, the European one is a rectangle.
- To analyze the circuits, the current through the resistance must be referenced with respect to the voltage between its terminals. There are two ways:
 - In the direction of the voltage drop that occurs in the resistor. **1**
 - In the direction of the increase in voltage in the resistor. **2**
- The relationship between voltage and current is defined in both cases by Ohm's Law as:

1 $v = i \cdot R$



CLASES PARTICULARES, TUTORÍAS TÉCNICAS ONLINE
LLAMA O ENVÍA WHATSAPP: 689 45 44 70

ONLINE PRIVATE LESSONS FOR SCIENCE STUDENTS
CALL OR WHATSAPP:689 45 44 70

Circuit elements: electric resistor (Ohm's Law)

- Short circuit: a resistor of null value ($R = 0$) behaves as a short circuit between its terminals a and b.
 - The voltage drop will be zero regardless of the current flowing through the resistance.

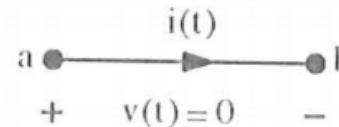
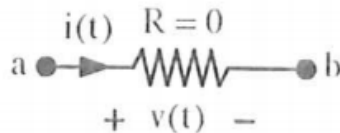

- Open circuit: if the resistor has infinite value ($R = \infty$) it behaves like an open circuit between its two terminals a and b.
 - Regardless of the potential difference between its extremes, the current flowing through the resistance will be zero.

Cartagena99

CLASES PARTICULARES, TUTORÍAS TÉCNICAS ONLINE
LLAMA O ENVÍA WHATSAPP: 689 45 44 70

ONLINE PRIVATE LESSONS FOR SCIENCE STUDENTS
CALL OR WHATSAPP:689 45 44 70

Circuit elements: electric resistor (Ohm's Law)

- Conductance: the inverse of the resistance is called conductance, it is symbolized by the letter G and it is measured in Siemens [S].
 - Conductance symbolizes the ease with which the current flows through a certain element.
 - Optionally the Mho expression can be used for the units (it is the 'inverse' of Ohm) or an inverted omega Ω .
 - The symbol is the same as that of the resistance.
 - Example: a resistance of 8 Ω has a conductance of $(1/8 =) 0.125 \text{ S}$.

$$G = 1/R \text{ [S]}$$

Cartagena99

CLASES PARTICULARES, TUTORÍAS TÉCNICAS ONLINE
LLAMA O ENVÍA WHATSAPP: 689 45 44 70

ONLINE PRIVATE LESSONS FOR SCIENCE STUDENTS
CALL OR WHATSAPP:689 45 44 70

Circuit elements: electric resistor (Ohm's Law)

- The power in a resistor can be expressed as a function of said resistance and only one of the variables, current or voltage, using Ohm's Law in the general formula:

- Power in a resistor in terms of current:

$$p = v.i \quad \text{y} \quad v = i.R$$



$$p = i^2 R$$

- Power in a resistor in terms of tension:

$$p = v.i \quad \text{y} \quad i = v/R$$



$$p = \frac{v^2}{R}$$

- In a resistor the power is always positive since the resistor is a passive

Cartagena99

CLASES PARTICULARES, TUTORÍAS TÉCNICAS ONLINE
LLAMA O ENVÍA WHATSAPP: 689 45 44 70

ONLINE PRIVATE LESSONS FOR SCIENCE STUDENTS
CALL OR WHATSAPP:689 45 44 70

Circuit elements: electric resistor (Ohm's Law)

- Example: in each of the following circuits, determine the value of the unknown circuit variable and the power dissipated in each resistance.

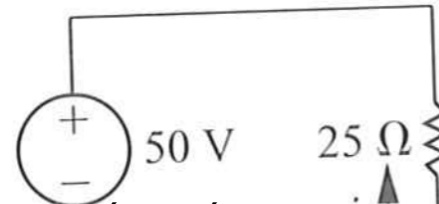
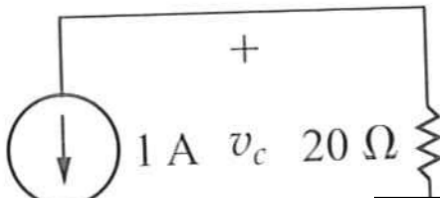
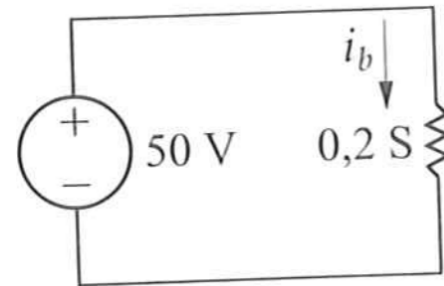
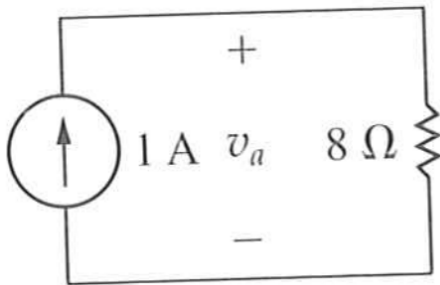

Cartagena99

CLASES PARTICULARES, TUTORÍAS TÉCNICAS ONLINE
LLAMA O ENVÍA WHATSAPP: 689 45 44 70

ONLINE PRIVATE LESSONS FOR SCIENCE STUDENTS
CALL OR WHATSAPP:689 45 44 70

Circuit elements: electric resistor (Ohm's Law)

- Real resistors: color code showing resistor value and tolerance

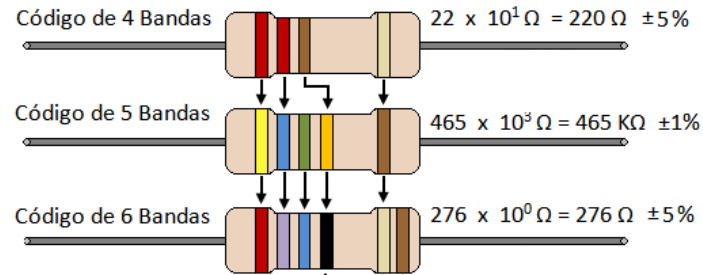
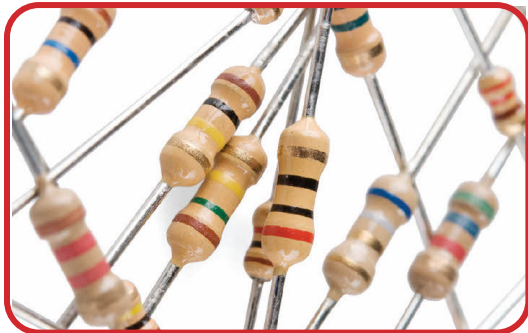

	Banda 1	Banda 2	Banda 3	Multiplicador	Tolerancia	Coficiente Temperatura
Negro	0	0	0	10^0		
Marrón	1	1	1	10^1	$\pm 1.00\%$	100 ppm/°C
Rojo	2	2	2	10^2	$\pm 2.00\%$	50 ppm/°C
Naranja	3	3	3	10^3		15 ppm/°C
Amarillo	4	4	4	10^4		
Verde	5	5	5	10^5	$\pm 0.50\%$	
Azul	6	6	6	10^6	$\pm 0.25\%$	10 ppm/°C
Violeta	7	7	7	10^7	$\pm 0.10\%$	5 ppm/°C

CLASES PARTICULARES, TUTORÍAS TÉCNICAS ONLINE
 LLAMA O ENVÍA WHATSAPP: 689 45 44 70

ONLINE PRIVATE LESSONS FOR SCIENCE STUDENTS
 CALL OR WHATSAPP: 689 45 44 70

Cartagena99



Circuit elements: electric sources

- An electrical source, or generator, is a device capable of converting non-electric energy into electrical energy and vice versa.
 - A battery during its discharge converts chemical energy into electrical energy and when it is charged, it converts electrical energy into chemical energy.
 - A dynamo converts mechanical energy into electrical energy and vice versa.
 - When it operates in the mechanical-to-electric conversion mode, it is called a generator.
 - When it operates in the conversion mode from electric to mechanical, it is called motor.
- Voltage source: the one that supplies a fixed potential difference between its terminals regardless of the current flowing through it.
- Current source: the one through which a fixed current flows regardless of the voltage that exists between its terminals.

Cartagena99

CLASES PARTICULARES, TUTORÍAS TÉCNICAS ONLINE
LLAMA O ENVÍA WHATSAPP: 689 45 44 70

ONLINE PRIVATE LESSONS FOR SCIENCE STUDENTS
CALL OR WHATSAPP:689 45 44 70

Circuit elements: electric sources

- Voltage source: the one that supplies a fixed potential difference between its terminals regardless of the current flowing through it.
 - The polarity of the voltage is indicated inside the generator symbol.
 - A + sign is assigned to the side of greater potential.
 - Voltage source units are volts [V].

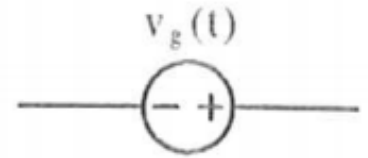

VOLTAGE SOURCE

- Current source: the one through which a fixed current flows regardless of the voltage that exists between its terminals.
 - The polarity of the current is indicated inside the generator symbol by an arrow pointing to the circulation side of the current.

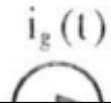

Cartagena99

CLASES PARTICULARES, TUTORÍAS TÉCNICAS ONLINE
LLAMA O ENVÍA WHATSAPP: 689 45 44 70

ONLINE PRIVATE LESSONS FOR SCIENCE STUDENTS
CALL OR WHATSAPP:689 45 44 70

Circuit elements: electric sources

- Different classifications of sources can be established:

1

- Ideal source: has not any type of losses.
- Real source: has losses.

2

- Continuous source: supplies a voltage (or current) of constant value over time.
- Alternating source: supplies a voltage (or current) that varies as a function of time.

3

- Independent source: supplies a voltage (or current) whose value does not depend on any other voltage or current at some other point in the circuit. The value of the voltage (or current) supplied is specified exclusively by the value of the source itself.

Cartagena99

CLASES PARTICULARES, TUTORÍAS TÉCNICAS ONLINE
LLAMA O ENVÍA WHATSAPP: 689 45 44 70

ONLINE PRIVATE LESSONS FOR SCIENCE STUDENTS
CALL OR WHATSAPP:689 45 44 70

Circuit elements: electric sources

- Ideal and real sources: real sources are associated with an internal resistance whose effect is to model losses. The value of that resistance is indicated next to the generator symbol.

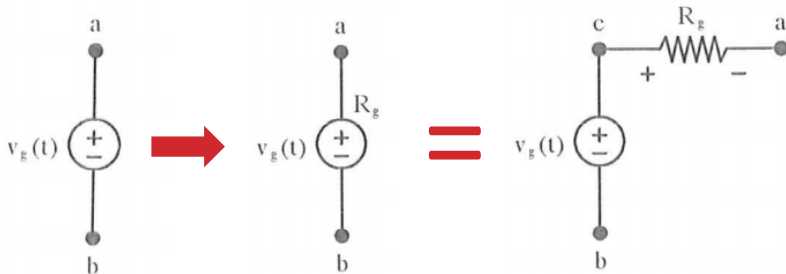

IDEAL VOLTAGE SOURCE VS REAL VOLTAGE SOURCE

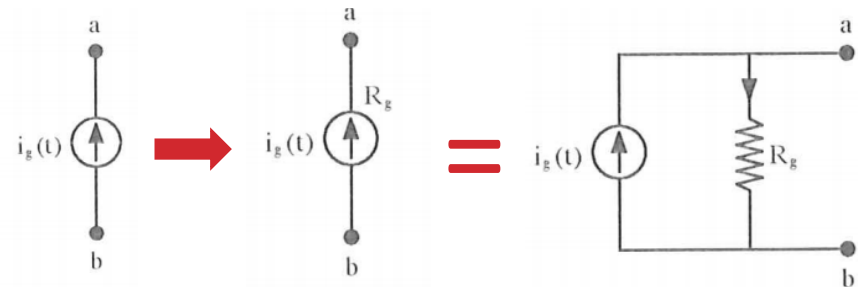

IDEAL CURRENT SOURCE VS REAL CURRENT SOURCE

- Real voltage sources vs ideal voltage sources: The ideal source sets the voltage value between its terminals so that $v_{g, \text{ideal}}(t) = V_a - V_b$. The real source has a resistance whose effect is to decrease the value of the voltage that the generator delivers to the circuit so that $v_{g, \text{real}}(t) < V_a - V_b$. The resistance is modeled with a series resistor.
- Real current sources vs ideal current sources: the ideal source sets the current value between its

Cartagena99

CLASES PARTICULARES, TUTORÍAS TÉCNICAS ONLINE
LLAMA O ENVÍA WHATSAPP: 689 45 44 70

ONLINE PRIVATE LESSONS FOR SCIENCE STUDENTS
CALL OR WHATSAPP: 689 45 44 70

Circuit elements: electric sources

- DC and AC sources: In AC sources, the voltage or current supplied varies with time, they are symbolized with non-capital letters and normally time dependence is indicated. In DC sources the voltage or current supplied is constant and will be symbolized by omitting the explicit dependence with time and using capital letters.

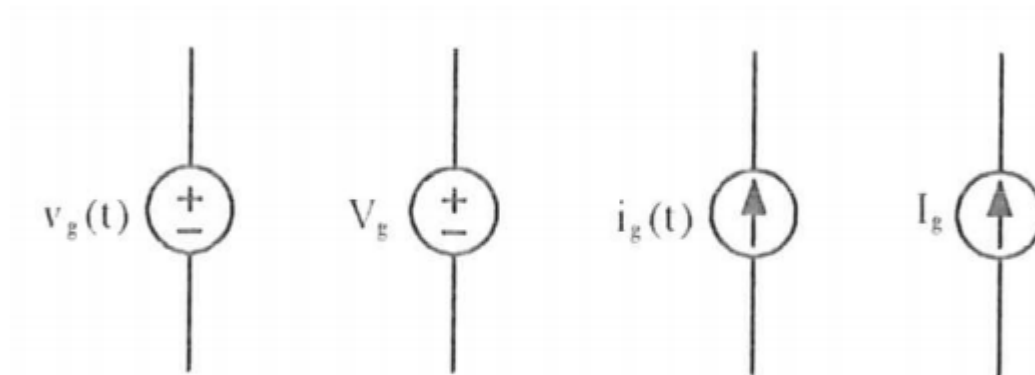

Cartagena99

CLASES PARTICULARES, TUTORÍAS TÉCNICAS ONLINE
LLAMA O ENVÍA WHATSAPP: 689 45 44 70

ONLINE PRIVATE LESSONS FOR SCIENCE STUDENTS
CALL OR WHATSAPP:689 45 44 70

Circuit elements: electric sources

- Independent and dependent sources:** independent sources are symbolized with circles and dependent sources with diamonds. Voltage-dependent sources can be controlled by voltage or current. The same applies to current-dependent sources.

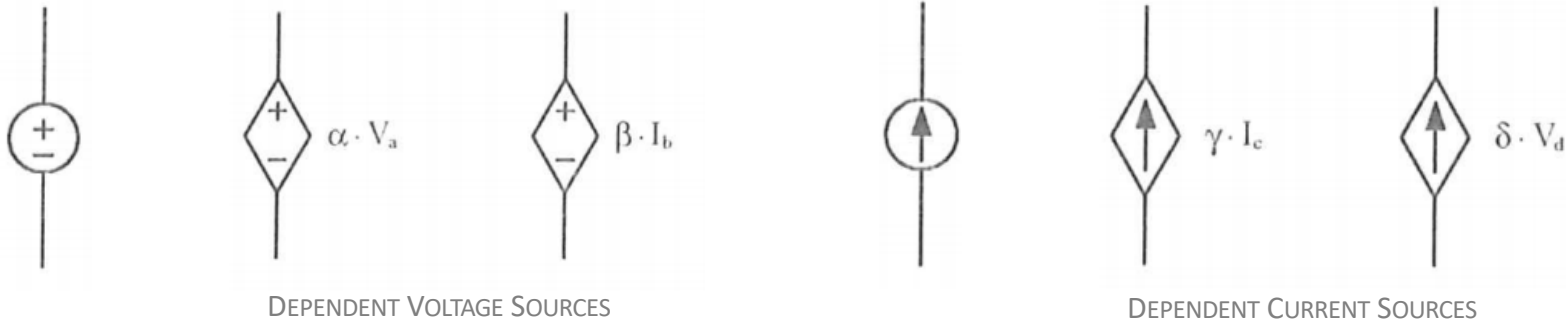

- To fully define a **voltage controlled source** it is necessary to indicate the **control voltage V_x** , the **equation** that allows controlling the supplied voltage V_s or current I_s and the **reference polarity** of V_s or I_s .
- To fully define a **current controlled source**, it is necessary to indicate the **control current I_x** , the

Cartagena99

CLASES PARTICULARES, TUTORIAS TECNICAS ONLINE
 LLAMA O ENVIA WHATSAPP: 689 45 44 70

ONLINE PRIVATE LESSONS FOR SCIENCE STUDENTS
 CALL OR WHATSAPP:689 45 44 70

Circuit elements: electric sources

- EXAMPLE: Using the definitions of ideal sources of voltage and current, indicate which of the following interconnections are admissible and which do not comply with the restrictions imposed by those ideal sources.

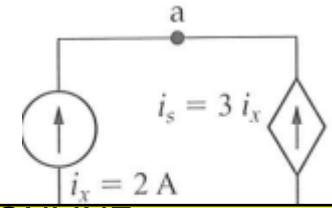
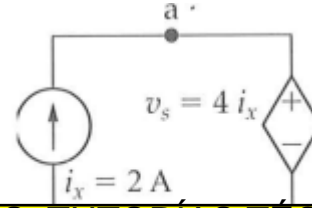
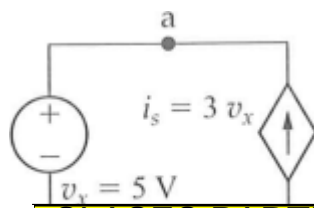
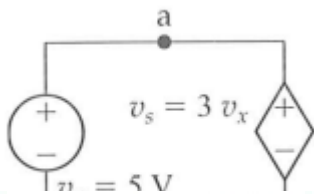
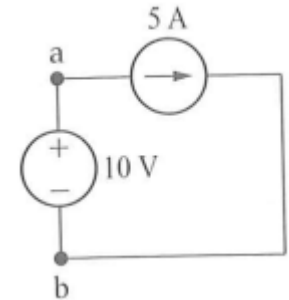
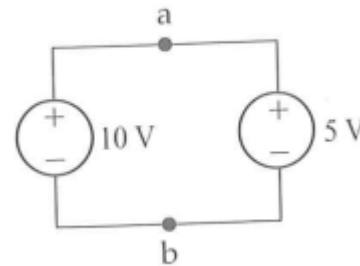
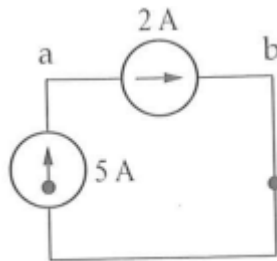
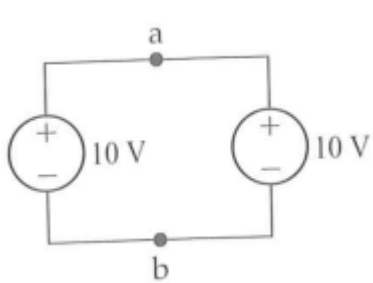

CLASES PARTICULARES, TUTORÍAS TÉCNICAS ONLINE
 LLAMA O ENVÍA WHATSAPP: 689 45 44 70

ONLINE PRIVATE LESSONS FOR SCIENCE STUDENTS
 CALL OR WHATSAPP: 689 45 44 70

Cartagena99

Kirchhoff's Laws

Cartagena99

CLASES PARTICULARES, TUTORÍAS TÉCNICAS ONLINE
LLAMA O ENVIA WHATSAPP: 689 45 44 70

ONLINE PRIVATE LESSONS FOR SCIENCE STUDENTS
CALL OR WHATSAPP:689 45 44 70

Circuit topology

- **Topological definitions:** are those that have to do with the topology of a circuit, that is, with the way in which the elements are connected.
 - **Node:** point of a circuit where two or more elements join.
 - **Essential node:** point of a circuit where three or more elements join.
 - **Branch:** path connecting two nodes, and containing a single element.
 - **Essential branch:** path connecting two essential nodes without going through another essential node.
 - **Loop:** set of branches forming a closed path.
 - **Mesh:** loop not containing another loop inside it.

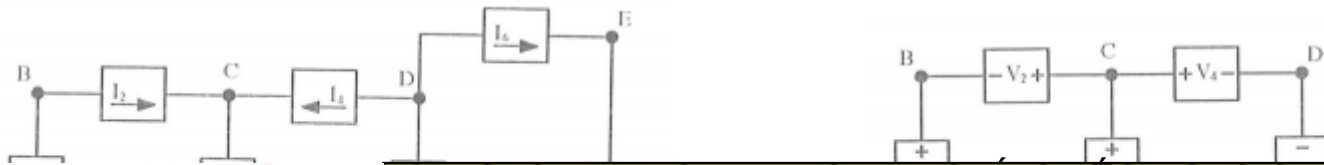

Cartagena99

CLASES PARTICULARES, TUTORÍAS TÉCNICAS ONLINE
LLAMA O ENVÍA WHATSAPP: 689 45 44 70

ONLINE PRIVATE LESSONS FOR SCIENCE STUDENTS
CALL OR WHATSAPP:689 45 44 70

Kirchhoff's Laws

- Kirchhoff's law of currents: the algebraic sum of the currents that converge in a node, is equal to zero.

$$\sum_n i_n = 0$$

- To use Kirchhoff's law of currents, each node must be assigned an algebraic sign indicating the direction of reference. Assigning a positive sign to a current that enters a node requires that we assign a negative sign to one that leaves and vice versa.
- In a circuit you can write as many equations as existent nodes, however, only N-1 will be independent.

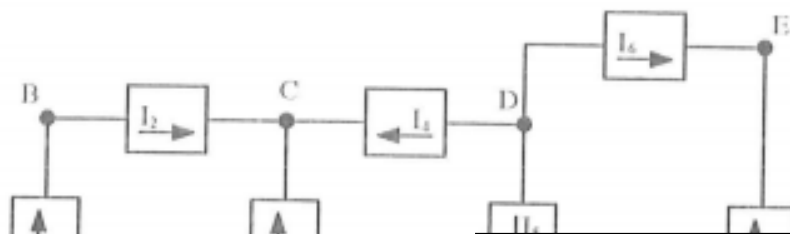

- Node A: $i_1 + i_3 - i_5 + i_7 = 0$
- Node B: $i_1 - i_2 = 0$
- Node C: $i_2 + i_3 + i_4 = 0$

CLASES PARTICULARES, TUTORÍAS TÉCNICAS ONLINE
 LLAMA O ENVÍA WHATSAPP: 689 45 44 70

ONLINE PRIVATE LESSONS FOR SCIENCE STUDENTS
 CALL OR WHATSAPP: 689 45 44 70

Kirchhoff's Laws

- Kirchhoff's law of tension: the algebraic sum of the voltage drops in a loop, is equal to zero.

$$\sum_n v_n = 0$$

- To use Kirchhoff's law of tensions, we must assign an algebraic sign (reference direction) to each loop. As we trace a closed path, each tension will appear in the loop as an increase or a drop in the direction in which we draw the loop.
- In a circuit you can write as many different equations as there are loops in the circuit. However only some of them will be independent (defined by the number of loops).

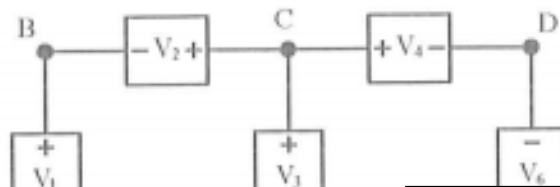

- Loop ABCA: $V_1 + V_2 - V_3 = 0$
- Loop ACDEA: $V_3 - V_4 + V_6 - V_5 = 0$

CLASES PARTICULARES, TUTORÍAS TÉCNICAS ONLINE
LLAMA O ENVÍA WHATSAPP: 689 45 44 70

ONLINE PRIVATE LESSONS FOR SCIENCE STUDENTS
CALL OR WHATSAPP: 689 45 44 70

Kirchhoff's Laws

- Example: Combine Kirchhoff's laws and Ohm's law to calculate i_o in the circuit. Check that the solution obtained is correct by making a power budget.

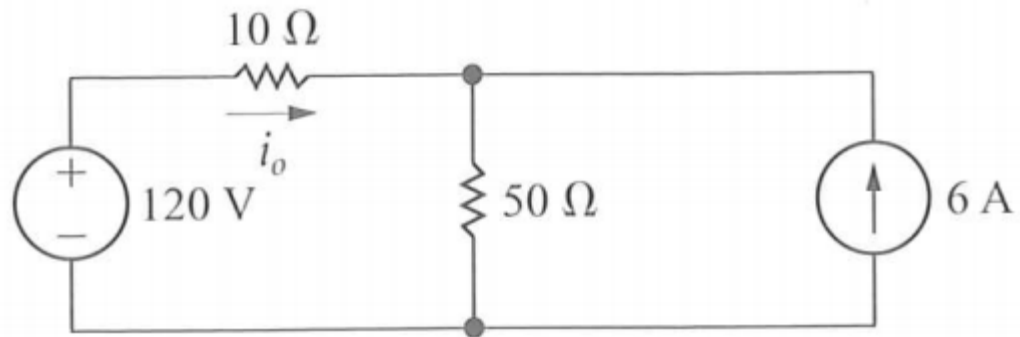

Cartagena99

CLASES PARTICULARES, TUTORÍAS TÉCNICAS ONLINE
LLAMA O ENVÍA WHATSAPP: 689 45 44 70

ONLINE PRIVATE LESSONS FOR SCIENCE STUDENTS
CALL OR WHATSAPP:689 45 44 70

Kirchhoff's Laws: circuits with dependent sources

- If there are dependent sources, new unknowns appear (control variables of the dependent sources), when applying the previous methods of circuit resolution.
- Example: Use Kirchhoff's Laws and Ohm's Law to calculate V_o . Check that the solution is correct by means of a power budget calculation.

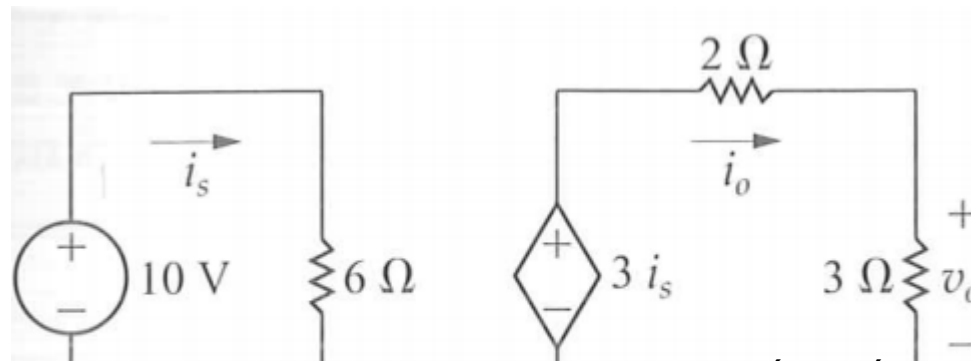

Cartagena99

CLASES PARTICULARES, TUTORÍAS TÉCNICAS ONLINE
LLAMA O ENVÍA WHATSAPP: 689 45 44 70

ONLINE PRIVATE LESSONS FOR SCIENCE STUDENTS
CALL OR WHATSAPP:689 45 44 70

Kirchhoff's Laws

- A circuit is solved when the voltages in the terminals of all the elements and the currents flowing across them have been determined.
 - However, the idea of having to solve a system of multiple equations to model a simple circuit is not very appealing.
 - Equation sets generated by applying Kirchhoff's Laws can be simplified if we use a priori knowledge of the circuit.
 - For example, if the current flowing through a resistance is known, by means of Ohm's law, the voltage at its terminals can be calculated. In this way, a single unknown can be assigned to each resistance.
 - The number of equations can be simplified if there are only two elements connected to a node (series connection). In that case, the current through both elements will be the same and the number of equations can be reduced by one.
- Combining an adequate understanding of Kirchhoff's laws, Ohm's law and the behavior of dependent and independent sources, it is possible to solve a large number of simple circuits.

- In the next block we will study much more effective analytical techniques for circuit

Cartagena99

CLASES PARTICULARES, TUTORÍAS TÉCNICAS ONLINE
LLAMA O ENVÍA WHATSAPP: 689 45 44 70

ONLINE PRIVATE LESSONS FOR SCIENCE STUDENTS
CALL OR WHATSAPP:689 45 44 70

Circuit elements association

Cartagena99

CLASES PARTICULARES, TUTORÍAS TÉCNICAS ONLINE
LLAMA O ENVIA WHATSAPP: 689 45 44 70

ONLINE PRIVATE LESSONS FOR SCIENCE STUDENTS
CALL OR WHATSAPP:689 45 44 70

Circuit elements association

- Circuit elements of the same type can be associated to ease and simplify circuit solving.
 - Element associations can be in series or in parallel.
- Two circuit elements are connected in series when they are placed one after the other, that is, when they have a common terminal that they do not share with any other element of the circuit.
 - When two elements are connected in series, the same current circulates through both (the voltage in each of them will be, in general, different).
- Two circuit elements are connected in parallel when they share their two terminals.
 - When two elements are connected in parallel, the voltage in both is identical (the current flowing through each of them will be, in general, different).

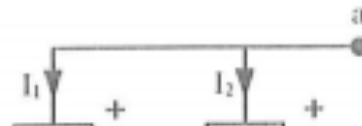

Cartagena99

CLASES PARTICULARES, TUTORÍAS TÉCNICAS ONLINE
LLAMA O ENVÍA WHATSAPP: 689 45 44 70

ONLINE PRIVATE LESSONS FOR SCIENCE STUDENTS
CALL OR WHATSAPP:689 45 44 70

Circuit elements association

- Series resistors: The series association of several resistors between two terminals a and b, is equivalent to a single resistor, connected between these two terminals, whose resistance is the the sum of all of the independent resistances:

$$R_{eq} = R_1 + R_2 + \dots + R_N = \sum_{n=1}^N R_n$$

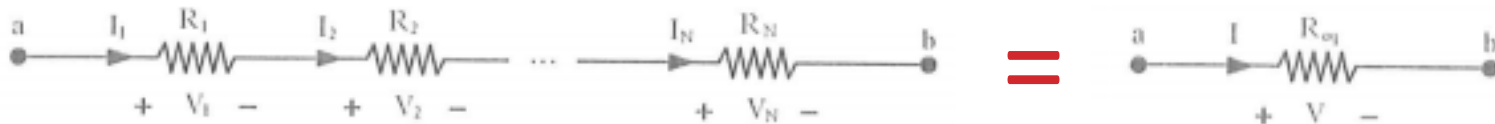

- In a series association of resistors it is fulfilled that:
 - Current flowing through the resistors is the same, which is also coincident with the one flowing through the equivalent resistor.

$$I_1 = I_2 = \dots = I_N = I$$

- Voltage drop is different in each resistor (unless two of them have equal resistance), and the sum of the voltage drops in each resistor is equal to the voltage drop between

Cartagena99

CLASES PARTICULARES, TUTORIAS TECNICAS ONLINE
LLAMA O ENVIA WHATSAPP: 689 45 44 70

ONLINE PRIVATE LESSONS FOR SCIENCE STUDENTS
CALL OR WHATSAPP: 689 45 44 70

Circuit elements association

- Association of resistances in parallel: The parallel association of several resistors between two terminals a and b, is equivalent to a single resistor, connected between these two terminals, whose resistance value is the inverse of the sum of the inverses of all of the independent resistances:

$$\frac{1}{R_{eq}} = \frac{1}{R_1} + \frac{1}{R_2} + \dots + \frac{1}{R_N} = \sum_{n=1}^N \frac{1}{R_n}$$

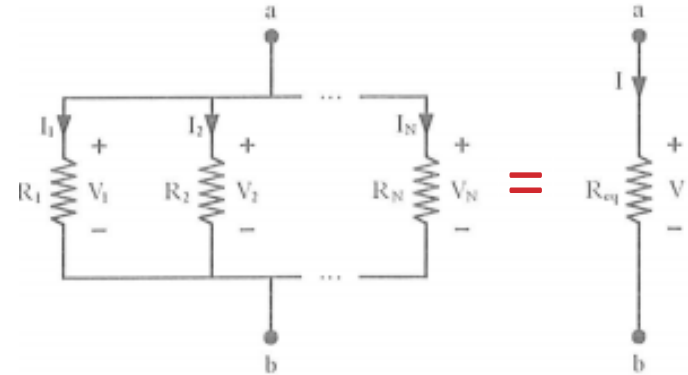

- In a parallel association of resistances it is fulfilled that:
 - In all the resistors the same voltage drop. This voltage drop is coincident with the voltage drop that exists between the terminals of the equivalent resistor.
- $$V_1 = V_2 = \dots = V_N = V$$
- The current flowing across each resistor, in principle different (unless the resistance is the same), and the sum of the currents flowing through each resistor is equal to the current flowing through the equivalent resistor.

Cartagena99

CLASES PARTICULARES, TUTORÍAS TÉCNICAS ONLINE
LLAMA O ENVÍA WHATSAPP: 689 45 44 70

ONLINE PRIVATE LESSONS FOR SCIENCE STUDENTS
CALL OR WHATSAPP: 689 45 44 70

Circuit elements association

- Example: calculate the currents in the circuit. Verify that the Kirchhoff's Laws and calculate the power budget.

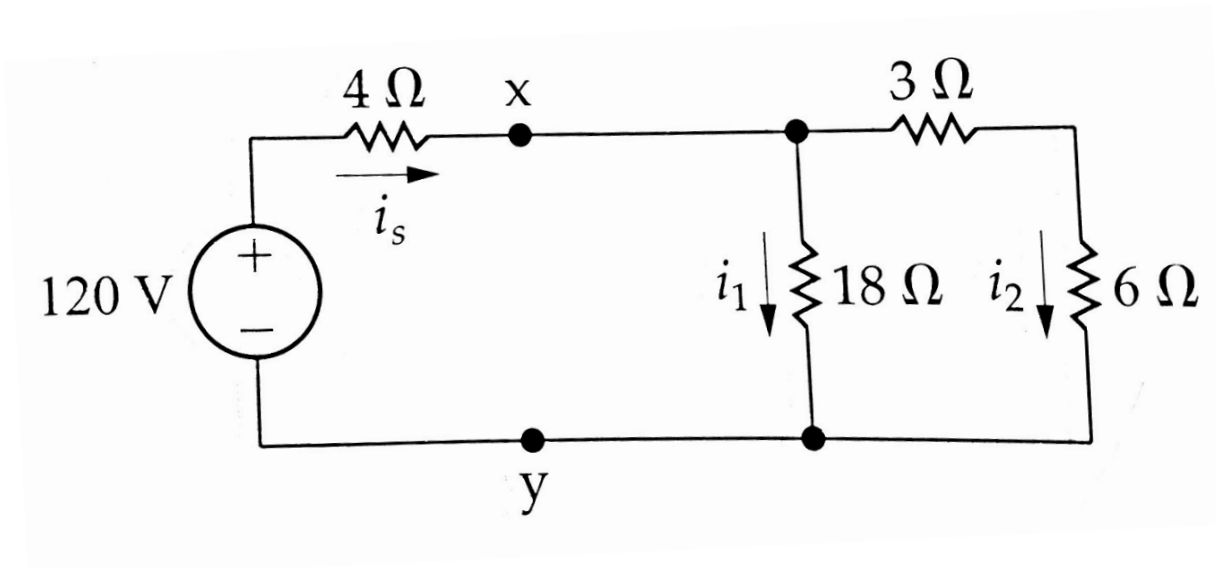

Cartagena99

CLASES PARTICULARES, TUTORÍAS TÉCNICAS ONLINE
LLAMA O ENVÍA WHATSAPP: 689 45 44 70

ONLINE PRIVATE LESSONS FOR SCIENCE STUDENTS
CALL OR WHATSAPP:689 45 44 70

Circuit elements association

- Voltage sources within a circuit can also be associated
 - Two voltage sources can always be connected in series regardless of their value. Their connection is equivalent to a single source whose voltage is the algebraic sum of the other two.

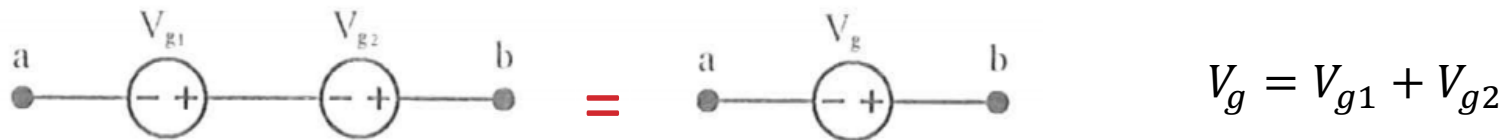

- Two voltage sources can only be connected in parallel, if both of them have the same voltage value and the same polarity. In addition, parallel connection of two voltage sources is equivalent to a single voltage source with the same voltage value.

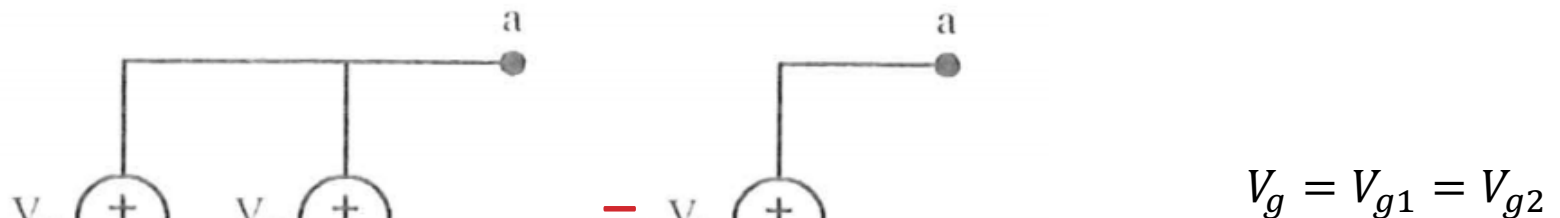

CLASES PARTICULARES, TUTORÍAS TÉCNICAS ONLINE
LLAMA O ENVÍA WHATSAPP: 689 45 44 70

ONLINE PRIVATE LESSONS FOR SCIENCE STUDENTS
CALL OR WHATSAPP:689 45 44 70

Cartagena99

Circuit elements association

- The current sources within a system can also be associated:
 - Two current sources can only be connected in series, if both of them have the same current value and the same polarity. Their connection is equivalent to a single current source with the same current value.

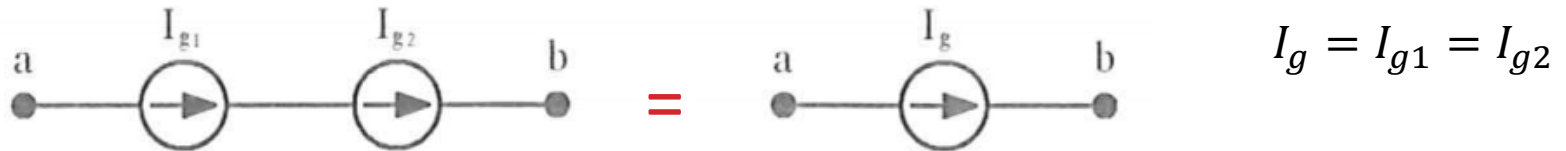

- Two current sources can always be connected in parallel, regardless of their current value. The parallel of two current sources corresponds to a single current source with a current value equal to the algebraic sum of the other two currents.

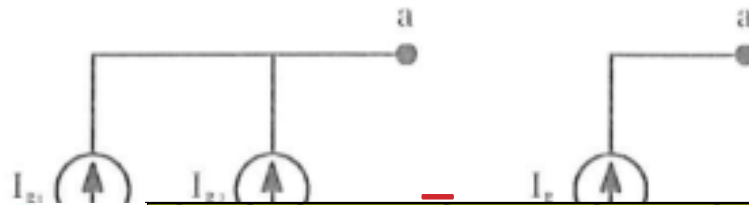

Cartagena99

CLASES PARTICULARES, TUTORÍAS TÉCNICAS ONLINE
LLAMA O ENVÍA WHATSAPP: 689 45 44 70

ONLINE PRIVATE LESSONS FOR SCIENCE STUDENTS
CALL OR WHATSAPP:689 45 44 70

Circuit elements association

■ Sources transformation:

- A voltage source in series with a resistor can be replaced, in a given pair of nodes, by a current generator in parallel with a resistor. The reverse transformation is equally possible.
- In both cases, the value of the resistance is the same, and the relationship between the voltage of the voltage source and the current of the current source, is given by Ohm's Law.

$$v_a(t) = R i_a(t)$$



CLASES PARTICULARES, TUTORÍAS TÉCNICAS ONLINE
LLAMA O ENVÍA WHATSAPP: 689 45 44 70

ONLINE PRIVATE LESSONS FOR SCIENCE STUDENTS
CALL OR WHATSAPP:689 45 44 70

Circuit elements association

- Example: calculate the power associated with the 6 V source by applying the source transformation technique, does that source absorb or deliver power?

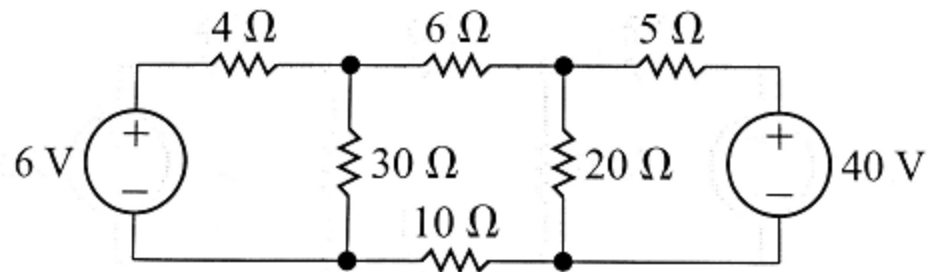

Cartagena99

CLASES PARTICULARES, TUTORÍAS TÉCNICAS ONLINE
LLAMA O ENVÍA WHATSAPP: 689 45 44 70

ONLINE PRIVATE LESSONS FOR SCIENCE STUDENTS
CALL OR WHATSAPP:689 45 44 70

Voltage and current dividers

Cartagena99

CLASES PARTICULARES, TUTORÍAS TÉCNICAS ONLINE
LLAMA O ENVIA WHATSAPP: 689 45 44 70

ONLINE PRIVATE LESSONS FOR SCIENCE STUDENTS
CALL OR WHATSAPP:689 45 44 70

Voltage dividers

- Sometimes it is necessary to obtain more than one voltage level from a single power source. One of the most used ways is from the so-called voltage dividers.
- A voltage divider is a circuit with which the voltage can be distributed within series elements. Each of the individual voltages v_j in which the total voltage v is divided can be calculated by applying the following rule:

$$v_j = iR_j = \frac{R_j}{R_{eq}} v$$

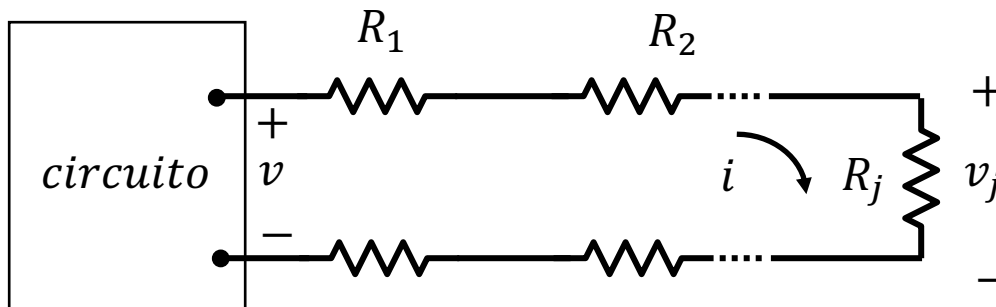

CLASES PARTICULARES, TUTORÍAS TÉCNICAS ONLINE
LLAMA O ENVÍA WHATSAPP: 689 45 44 70

ONLINE PRIVATE LESSONS FOR SCIENCE STUDENTS
CALL OR WHATSAPP:689 45 44 70

Cartagena99

Voltage dividers

- Demonstration: Voltage drop in each resistor of the circuit of the figure can be obtained in the following way:

- From the Kirchhoff's law of the currents it is necessary that both resistors support the same current. Applying Kirchhoff's Law to the closed loop we obtain:

$$v_s = iR_1 + iR_2,$$

- Or, equivalently:

$$i = \frac{v_s}{R_1 + R_2}.$$

- It is possible to calculate v_1 y v_2 by means of the Ohm's Law as:



$$v_1 = iR_1 = v_s \frac{R_1}{R_1 + R_2},$$

Cartagena99

CLASES PARTICULARES, TUTORÍAS TÉCNICAS ONLINE
LLAMA O ENVÍA WHATSAPP: 689 45 44 70

ONLINE PRIVATE LESSONS FOR SCIENCE STUDENTS
CALL OR WHATSAPP:689 45 44 70

Current dividers

- Likewise, it may be necessary to obtain more than one current level from a single power source. One of the most used ways is by means of the so-called current dividers.
- A current divider is used to divide the current between two circuit points connected in parallel. Each of the individual currents i_j into which the total current i is divided can be calculated by applying the following rule:

$$i_j = \frac{v}{R_j} = \frac{R_{eq}}{R_j} i$$

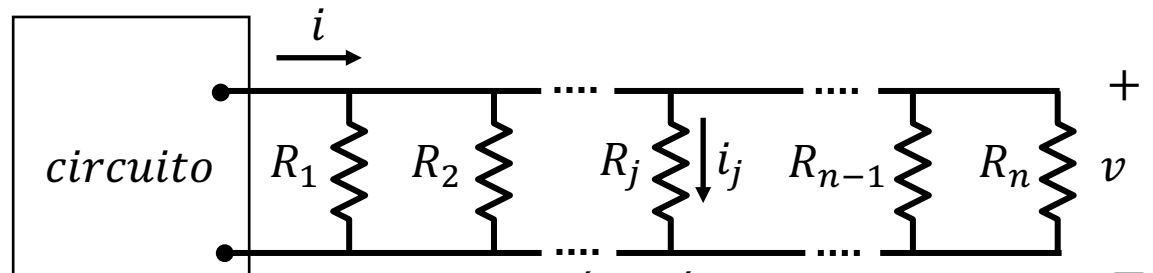

CLASES PARTICULARES, TUTORÍAS TÉCNICAS ONLINE
LLAMA O ENVÍA WHATSAPP: 689 45 44 70

ONLINE PRIVATE LESSONS FOR SCIENCE STUDENTS
CALL OR WHATSAPP:689 45 44 70

Cartagena99

Current dividers

- Demonstration: the current divider circuit of the figure is formed by 2 resistors in parallel with a current source. The divisor is designed to distribute the current i_s between R_1 and R_2 .
 - The relationship between i_s and the currents i_1 and i_2 in each resistor can be determined by directly applying Ohm's law and Kirchhoff's law of currents. The voltage of the parallel resistors is:

$$v = i_1 R_1 = i_2 R_2 = \frac{R_1 R_2}{R_1 + R_2} i_s.$$

- Applying Ohm's Law in each resistor from the previous equation:

$$i_1 = \frac{R_2}{R_1 + R_2} i_s,$$

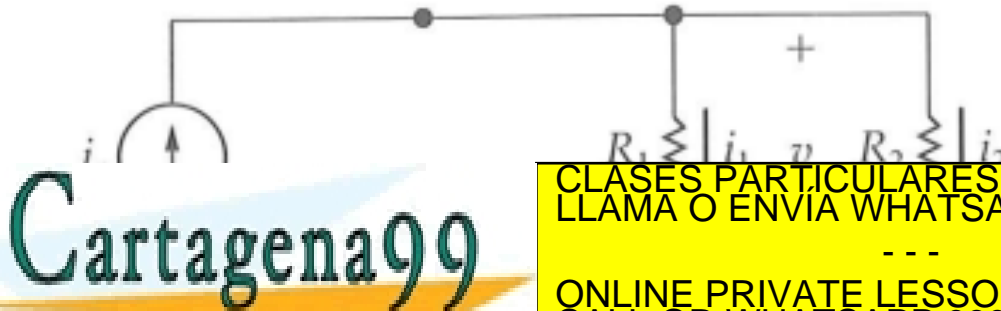

CLASES PARTICULARES, TUTORÍAS TÉCNICAS ONLINE
LLAMA O ENVÍA WHATSAPP: 689 45 44 70

ONLINE PRIVATE LESSONS FOR SCIENCE STUDENTS
CALL OR WHATSAPP:689 45 44 70

Voltage and current dividers

- Example: use the voltage division technique to determine the voltage drop v_0 on the 40 Ohm resistor. Use that value of v_0 to determine the current that flows through the 40 Ohm and the 30 Ohm resistors. How much power is absorbed in the 50 Ohm resistor?

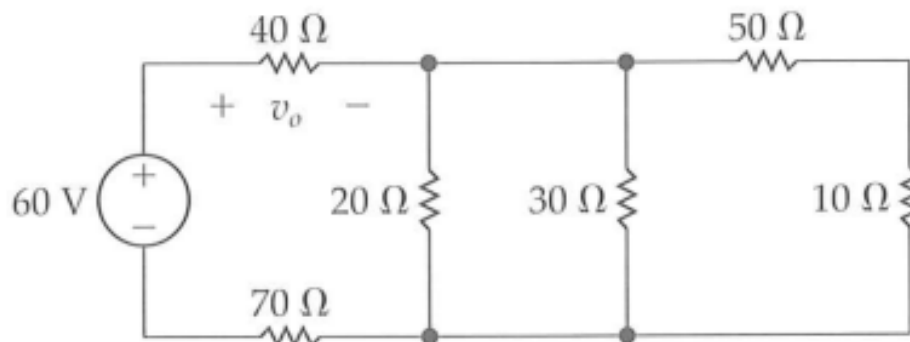

CLASES PARTICULARES, TUTORÍAS TÉCNICAS ONLINE
LLAMA O ENVÍA WHATSAPP: 689 45 44 70

ONLINE PRIVATE LESSONS FOR SCIENCE STUDENTS
CALL OR WHATSAPP:689 45 44 70

Cartagena99