

C Cl = 0			C Cl = 0,01		
	C H (ec [5])	C Na res [6]	C Na	C H (ec [5])	C Na res [6]
	9,992E-15	2,0000	1	1,0103E-14	2,000000
	1E-13	2,0000	0,1	1,1111E-13	2,000000
	1E-12	2,0000	0,01	0,0000001	1,999987
	1E-11	2,0000	0,001	0,009	0,292220
	1E-10	2,0000	0,0001	0,0099	0,030635
1	9,999E-10	1,9999	0,00001	0,00999	0,003078
01	9,902E-09	1,9872	0,000001	0,009999	0,000308
001	6,1803E-08	1,4272	0,0000001	0,0099999	0,000031
0001	9,5125E-08	0,2787	0,00000001	0,00999999	0,000003
	9,9501E-08	0,0305	1E-09	0,01	0,000000
	9,995E-08	0,0031	1E-10	0,01	0,000000
			0,002	0,008	0,555957
			0,004	0,006	1,013158
			0,02	1E-12	2,000000
			0,04	3,3333E-13	2,000000
			0,06	2E-13	2,000000
			0,08	1,4286E-13	2,000000



CLASES PARTICULARES, TUTORÍAS TÉCNICAS ONLINE  
 LLAMA O ENVÍA WHATSAPP: 689 45 44 70  
 ---  
 ONLINE PRIVATE LESSONS FOR SCIENCE STUDENTS  
 CALL OR WHATSAPP: 689 45 44 70

Figs. Ejercicio 12

$C = 2 \text{ N. Disol. Con } x_K = 0,7. t = 15 \text{ min}$

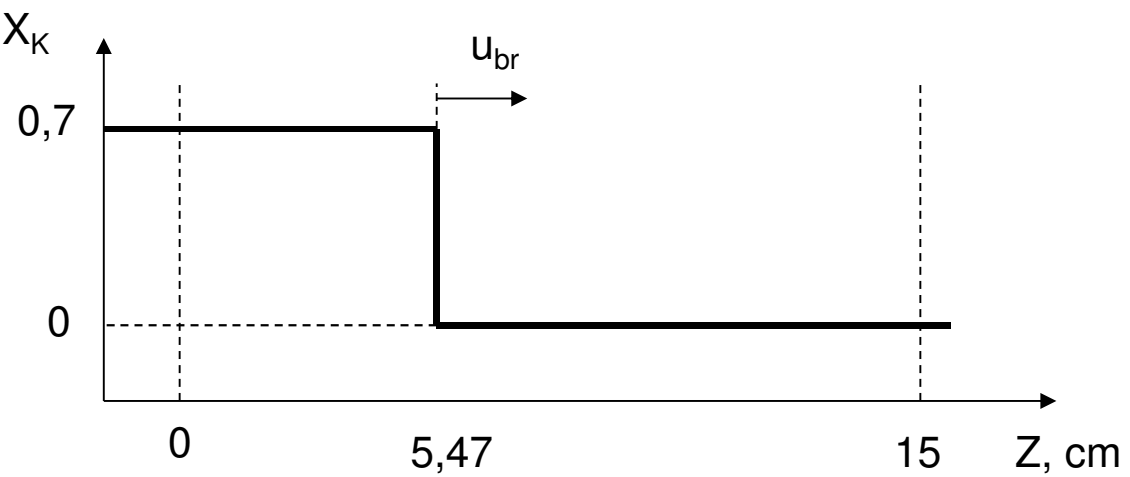

Cartagena99

CLASES PARTICULARES, TUTORÍAS TÉCNICAS ONLINE  
LLAMA O ENVÍA WHATSAPP: 689 45 44 70

---

ONLINE PRIVATE LESSONS FOR SCIENCE STUDENTS  
CALL OR WHATSAPP:689 45 44 70

Figs. Ejercicio 12 (cont.)

Disol. De NaCl C = 0,2 N. t = 5 min

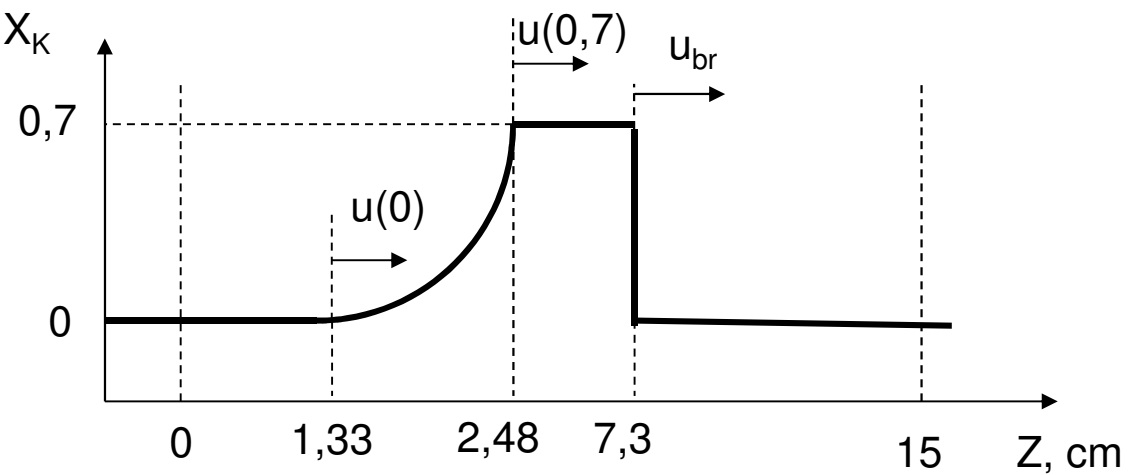
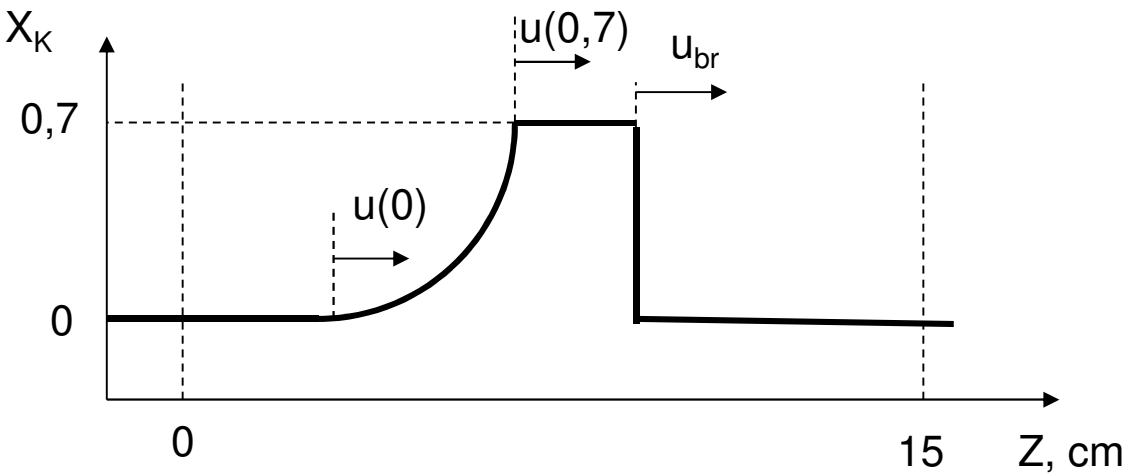

cm/min  
cm/min  
cabo de 5 min  
(al comienzo)

Cartagena99

CLASES PARTICULARES, TUTORÍAS TÉCNICAS ONLINE  
LLAMA O ENVÍA WHATSAPP: 689 45 44 70  
...  
ONLINE PRIVATE LESSONS FOR SCIENCE STUDENTS  
CALL OR WHATSAPP: 689 45 44 70

Figs. Ejercicio 12 (cont.)

Disol. de NaCl C = 1,0 N. t > 20 min

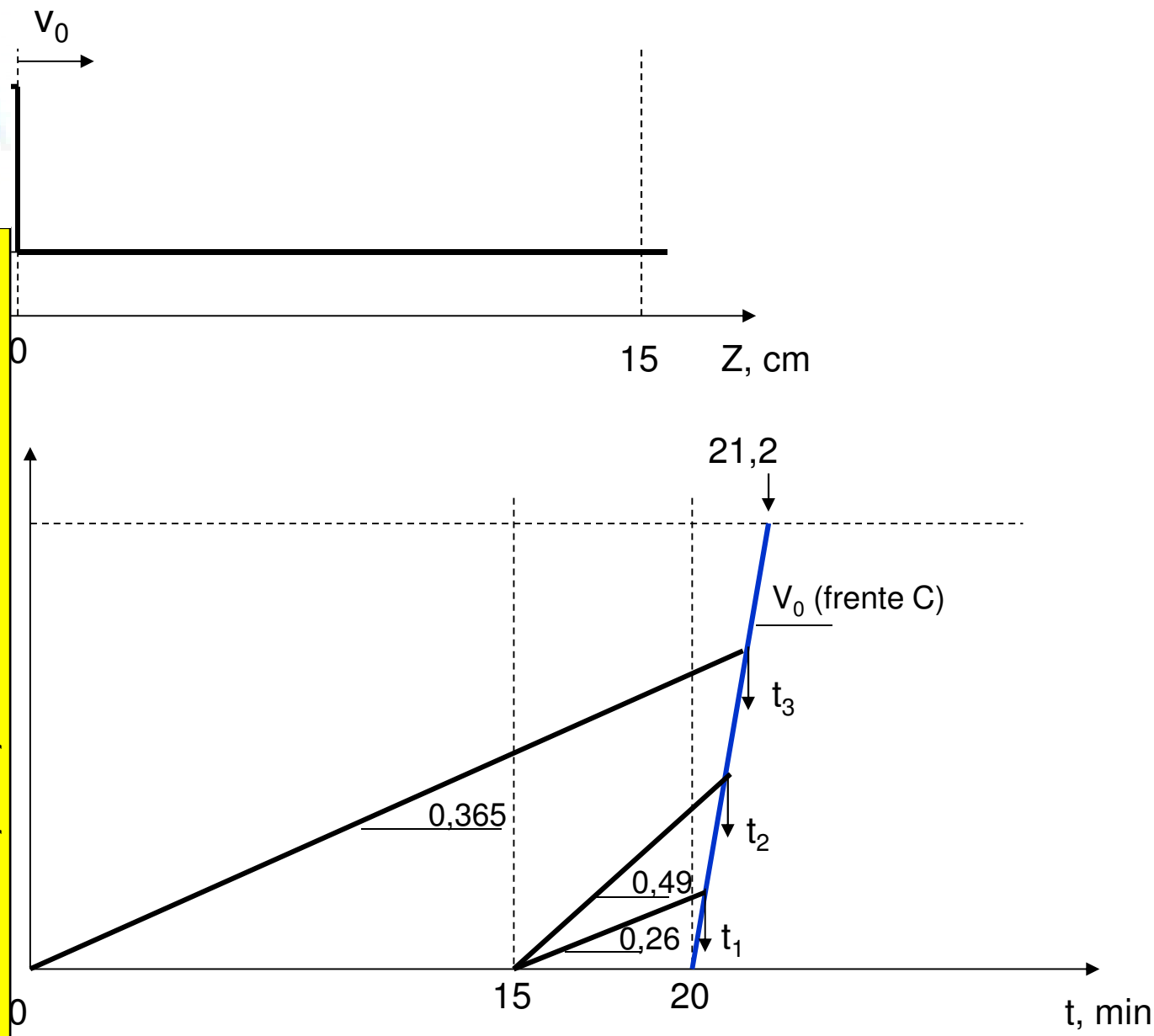

CLASES PARTICULARES, TUTORÍAS TÉCNICAS ONLINE  
LLAMA O ENVÍA WHATSAPP: 689 45 44 70  
---  
ONLINE PRIVATE LESSONS FOR SCIENCE STUDENTS  
CALL OR WHATSAPP: 689 45 44 70

Figs. Ejercicio 12 (cont.)

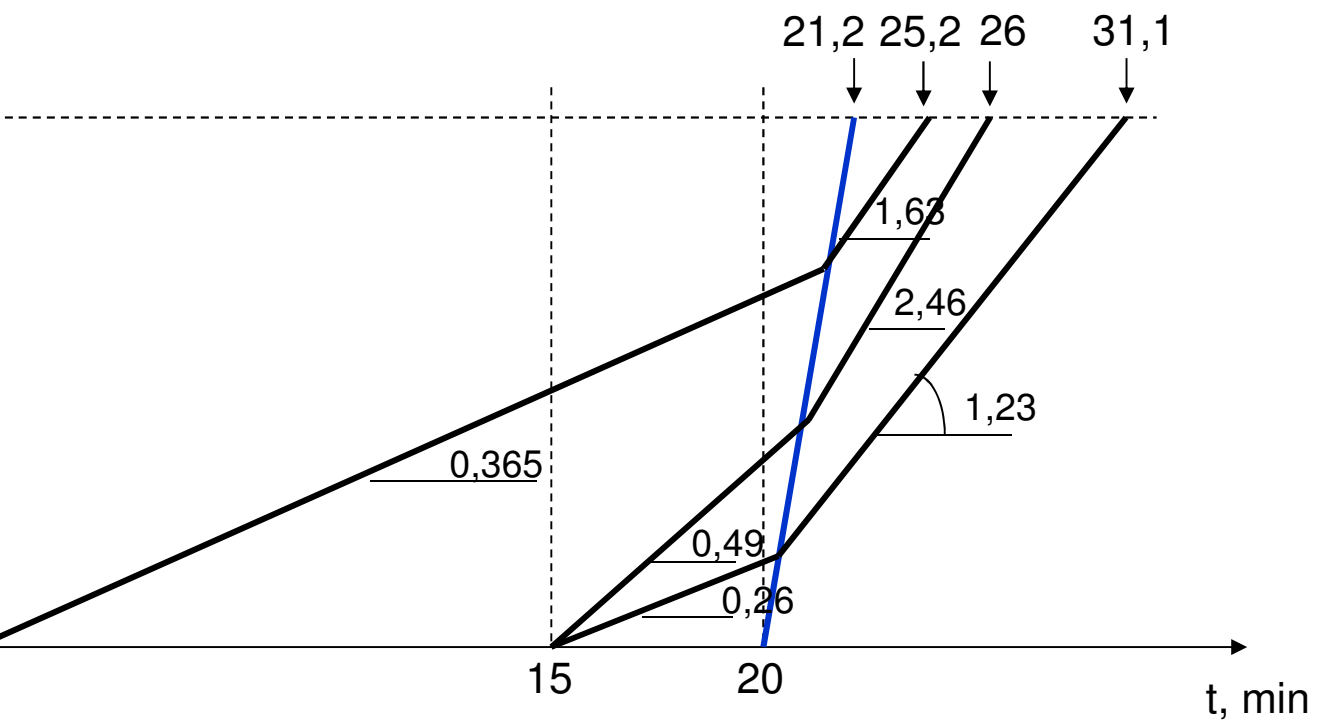

CLASES PARTICULARES, TUTORÍAS TÉCNICAS ONLINE  
LLAMA O ENVÍA WHATSAPP: 689 45 44 70

---

ONLINE PRIVATE LESSONS FOR SCIENCE STUDENTS  
CALL OR WHATSAPP:689 45 44 70

Cartagena99

Figs. Ejercicio 12 (cont.)

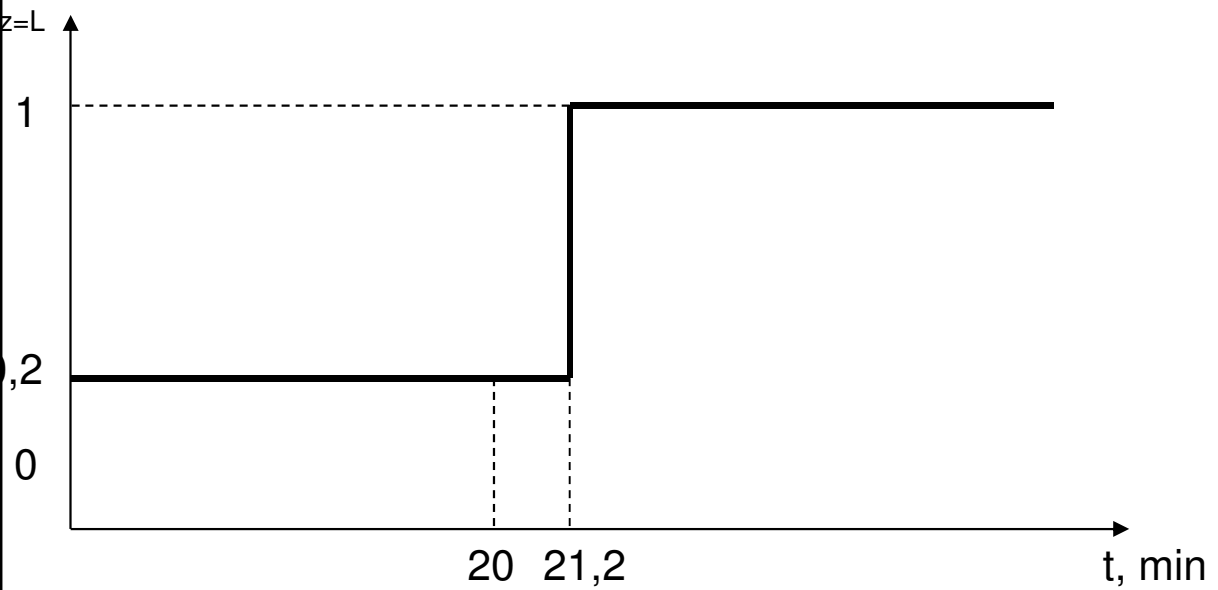
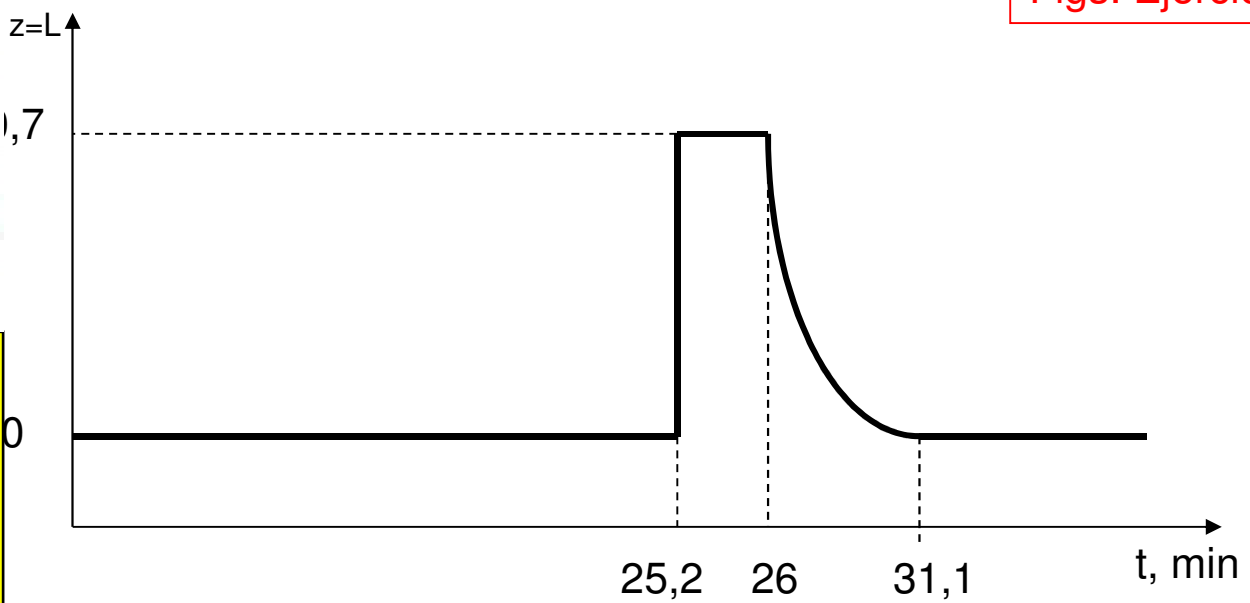

Cartagena99

CLASES PARTICULARES, TUTORÍAS TÉCNICAS ONLINE  
LLAMA O ENVÍA WHATSAPP: 689 45 44 70  
---  
ONLINE PRIVATE LESSONS FOR SCIENCE STUDENTS  
CALL OR WHATSAPP: 689 45 44 70

Figs. Ejercicio 13

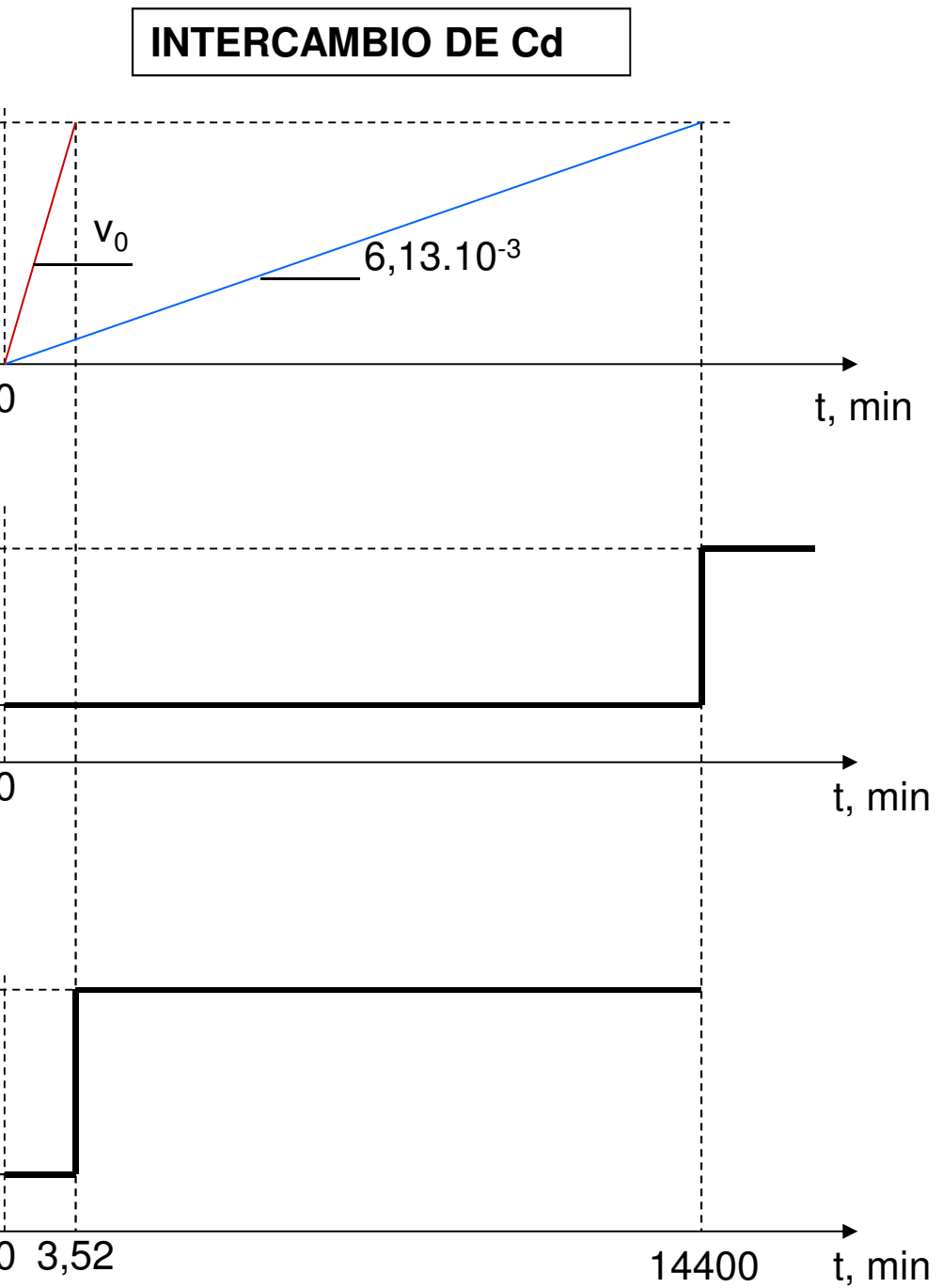

Cartagena99

CLASES PARTICULARES, TUTORÍAS TÉCNICAS ONLINE  
LLAMA O ENVÍA WHATSAPP: 689 45 44 70  
---  
ONLINE PRIVATE LESSONS FOR SCIENCE STUDENTS  
CALL OR WHATSAPP: 689 45 44 70

Figs. Ejercicio 13 (cont.)

INTERCAMBIO DE Cd

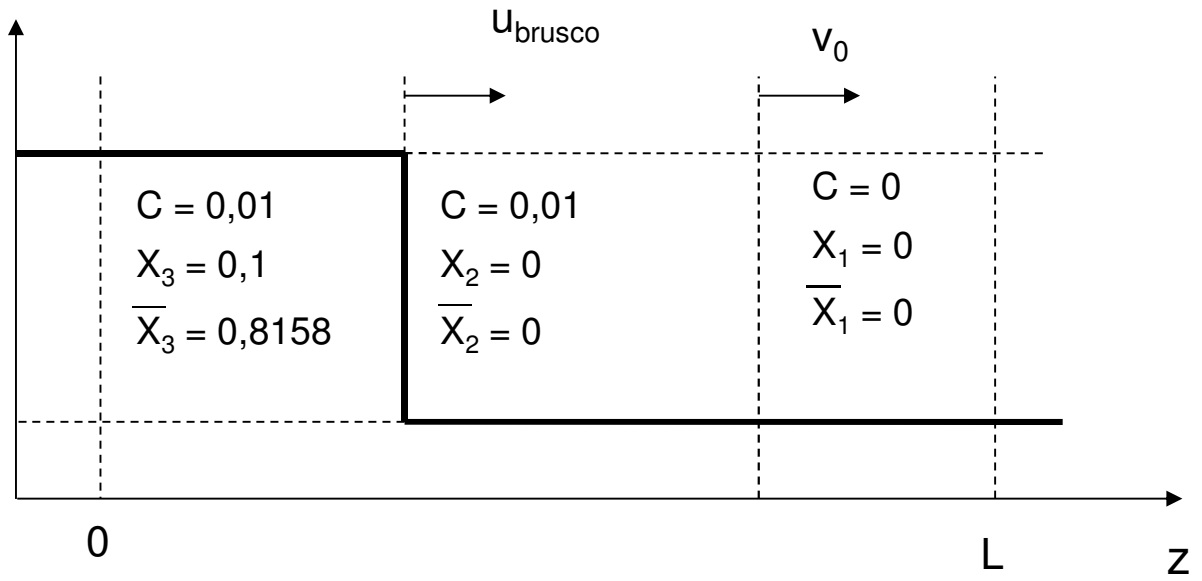

CLASES PARTICULARES, TUTORÍAS TÉCNICAS ONLINE  
LLAMA O ENVÍA WHATSAPP: 689 45 44 70  
...  
ONLINE PRIVATE LESSONS FOR SCIENCE STUDENTS  
CALL OR WHATSAPP:689 45 44 70



Figs. Ejercicio 13 (cont.)

### REGENERACIÓN

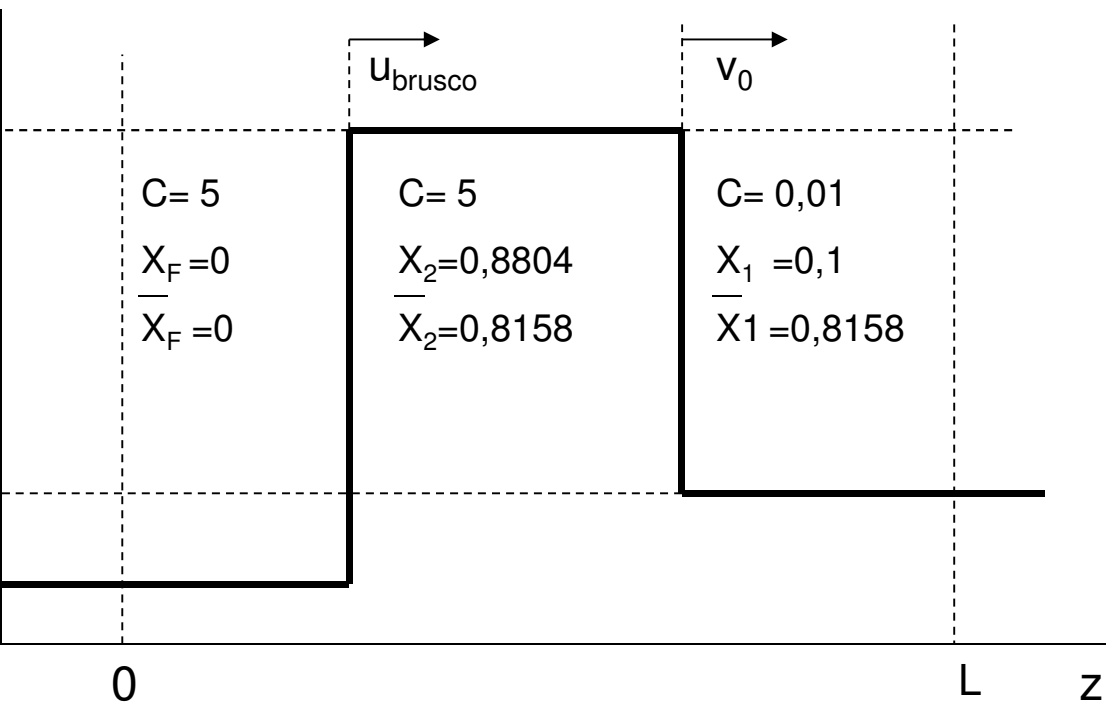

Cartagena99

CLASES PARTICULARES, TUTORÍAS TÉCNICAS ONLINE  
LLAMA O ENVÍA WHATSAPP: 689 45 44 70  
...  
ONLINE PRIVATE LESSONS FOR SCIENCE STUDENTS  
CALL OR WHATSAPP:689 45 44 70

Figs. Ejercicio 13 (cont.)

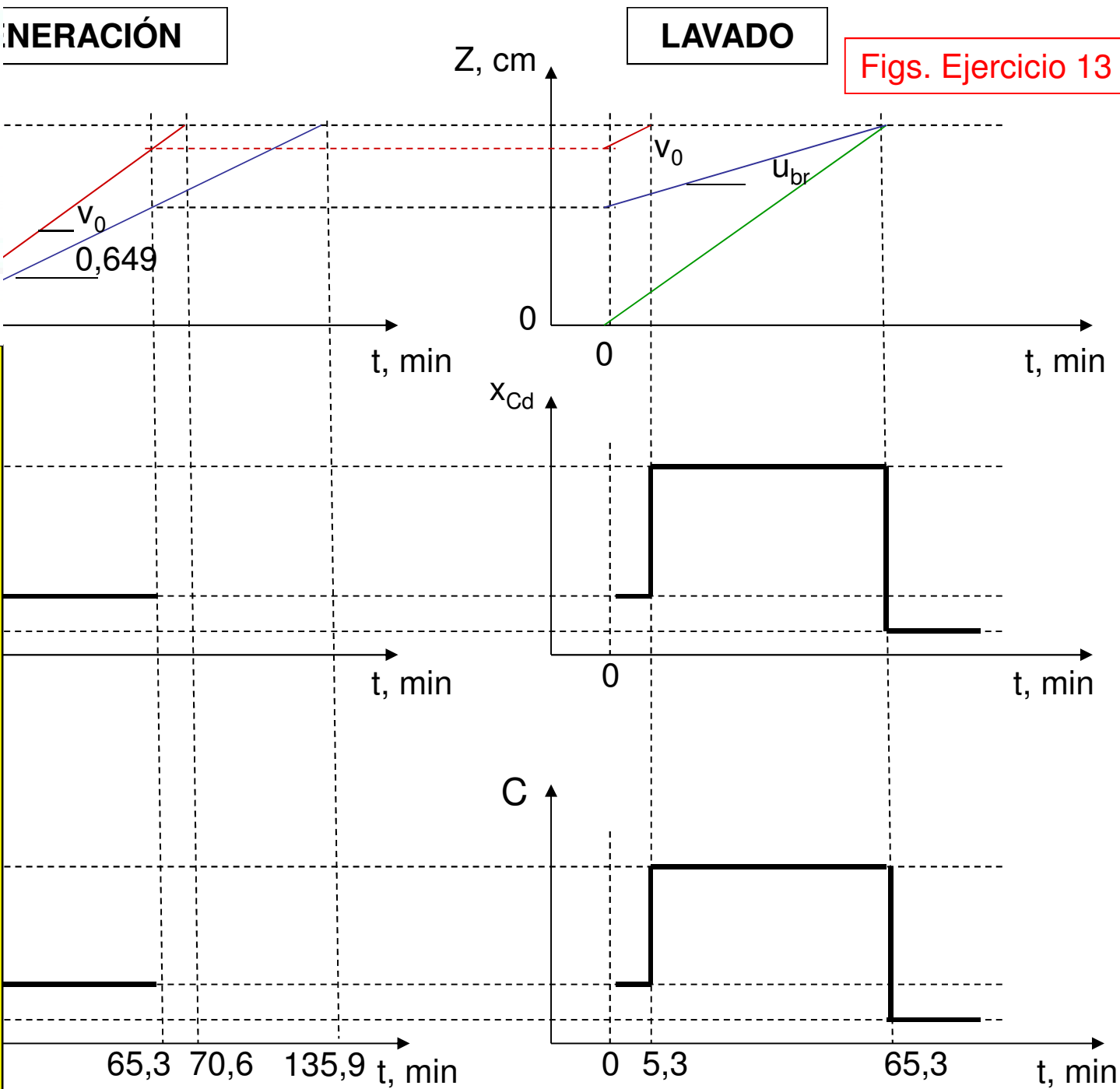

CLASES PARTICULARES, TUTORÍAS TÉCNICAS ONLINE  
 LLAMA O ENVÍA WHATSAPP: 689 45 44 70  
 ---  
 ONLINE PRIVATE LESSONS FOR SCIENCE STUDENTS  
 CALL OR WHATSAPP: 689 45 44 70

Figs. Ejercicio 14

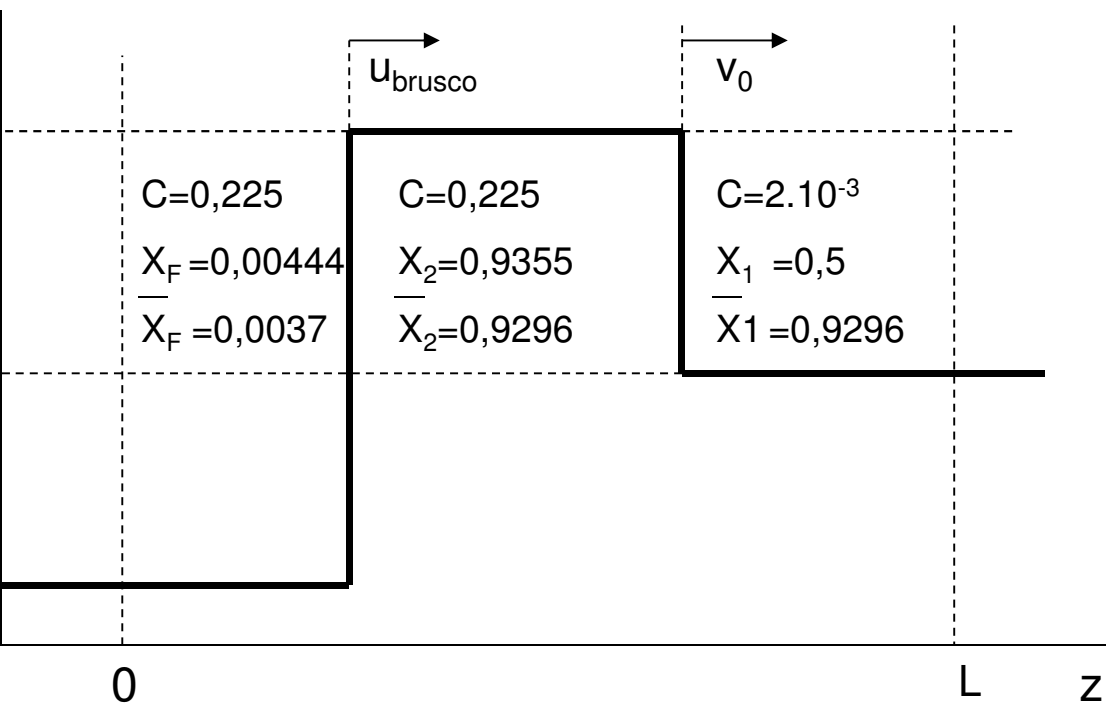

Cartagena99

CLASES PARTICULARES, TUTORÍAS TÉCNICAS ONLINE  
 LLAMA O ENVÍA WHATSAPP: 689 45 44 70  
 ---  
 ONLINE PRIVATE LESSONS FOR SCIENCE STUDENTS  
 CALL OR WHATSAPP:689 45 44 70

Figs. Ejerc. 14 (cont.)

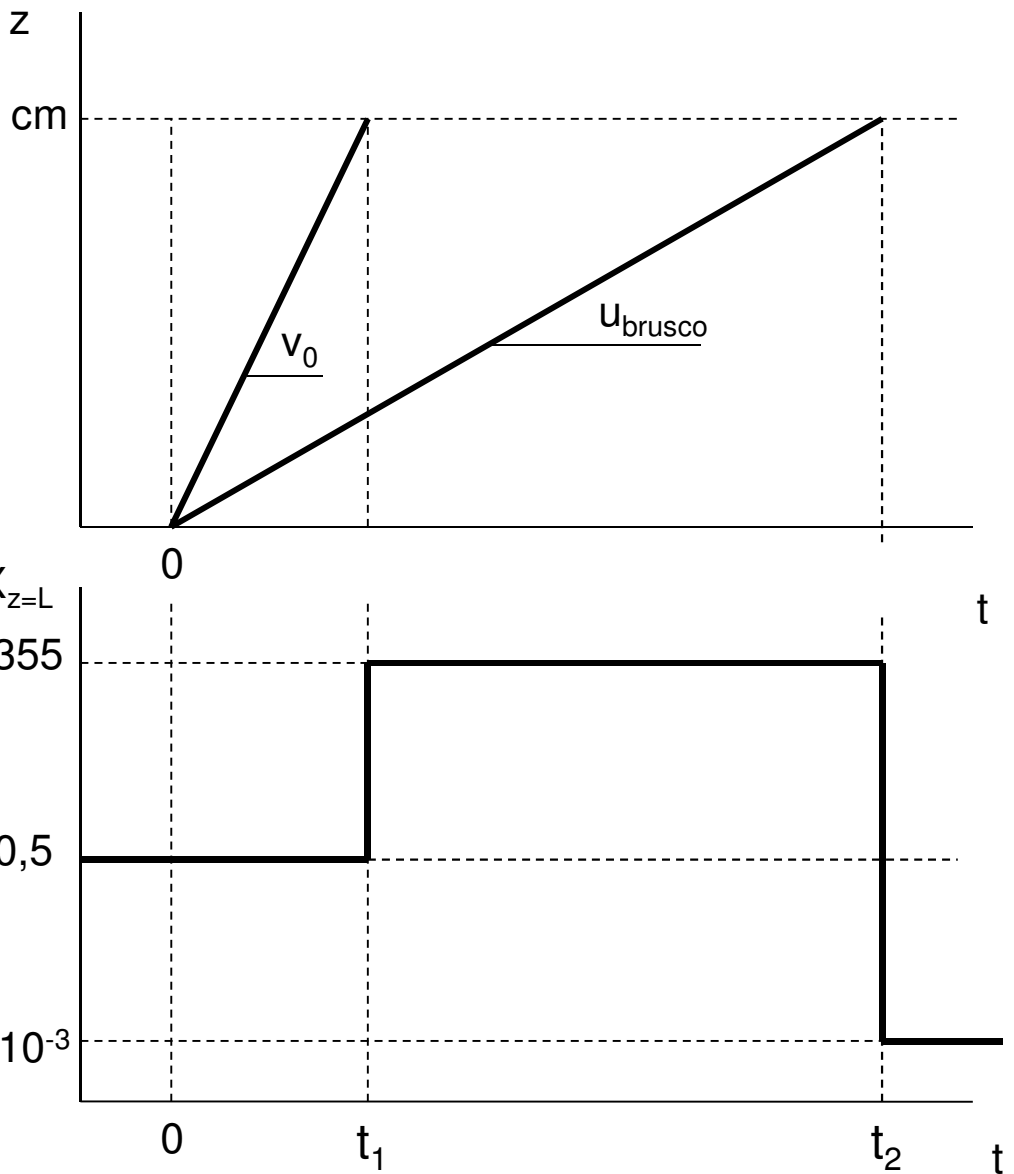

Cartagena99

CLASES PARTICULARES, TUTORÍAS TÉCNICAS ONLINE  
LLAMA O ENVÍA WHATSAPP: 689 45 44 70  
---  
ONLINE PRIVATE LESSONS FOR SCIENCE STUDENTS  
CALL OR WHATSAPP:689 45 44 70